

1:	9.6	↘
2:	9.3	↘
3:	10.6x	↗
4:	9.3	↘
5:	9.1	↙
6:	10.0	↙

<b>Serie</b>	<b>56.0</b>
<b>Total</b>	<b>0.0</b>

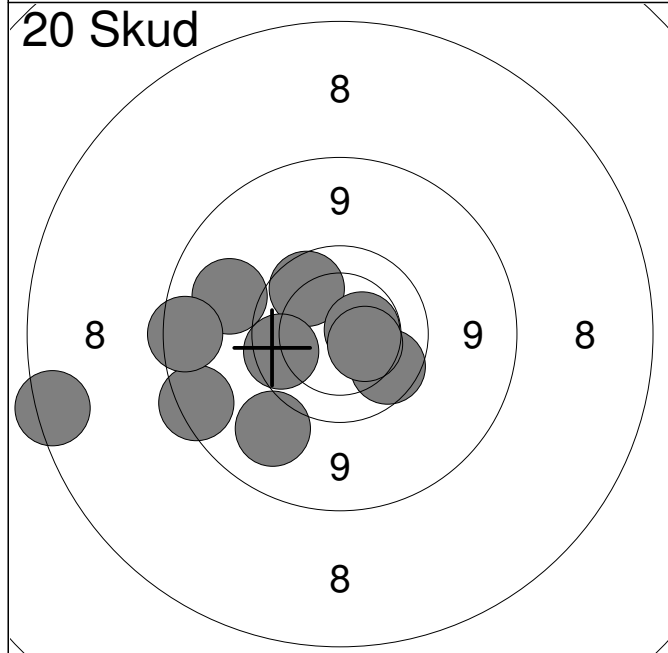

1:	9.9	↗
2:	7.8	↙
3:	8.8	↙
4:	9.2	↖
5:	10.5x	→
6:	9.2	↘
7:	9.9	↘
8:	8.8	↖
9:	9.8	↖
10:	10.4	→

<b>Serie</b>	<b>88.0</b>
<b>Total</b>	<b>88.0</b>

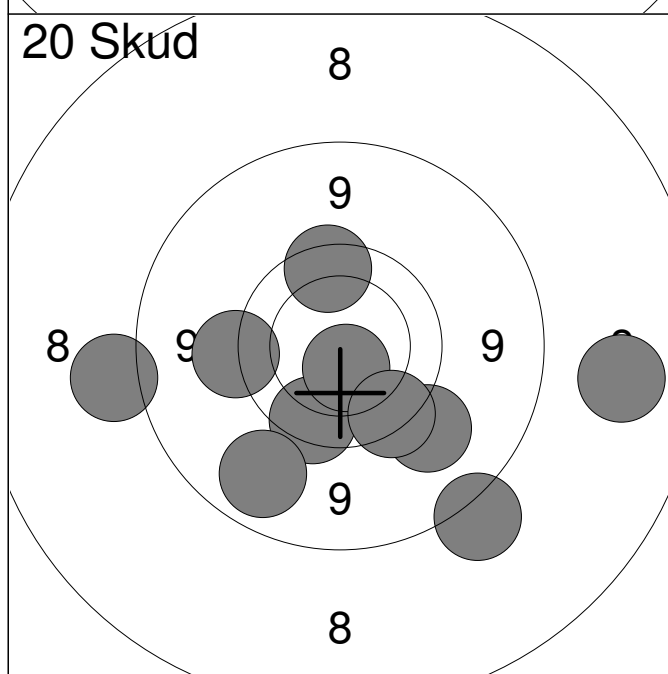

11:	9.5	↖
12:	9.7	↘
13:	9.3	↘
14:	10.6x	↘
15:	9.8	↗
16:	8.5	↖
17:	9.1	↘
18:	8.6	↘
19:	8.2	→
20:	9.7	↘

<b>Serie</b>	<b>88.0</b>
<b>Total</b>	<b>176.0</b>

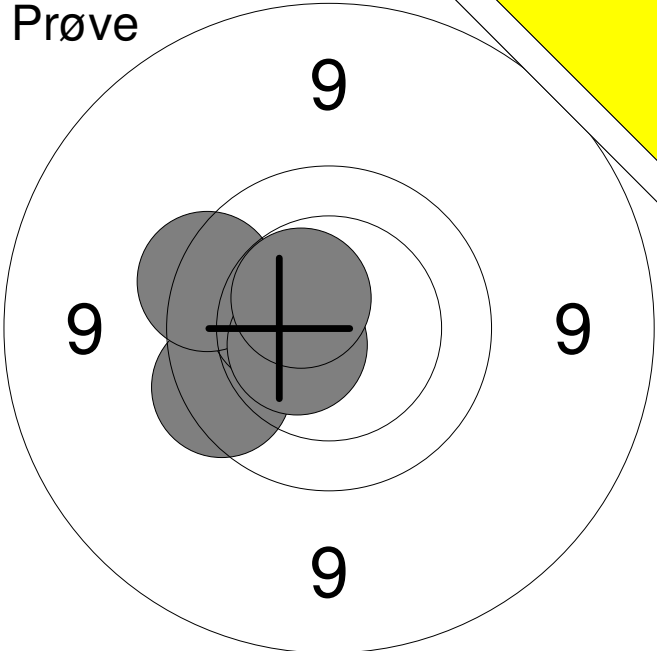
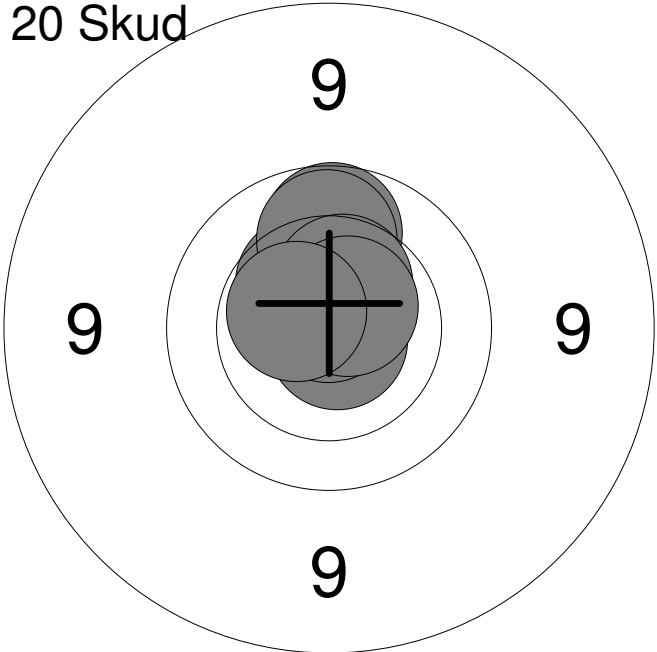
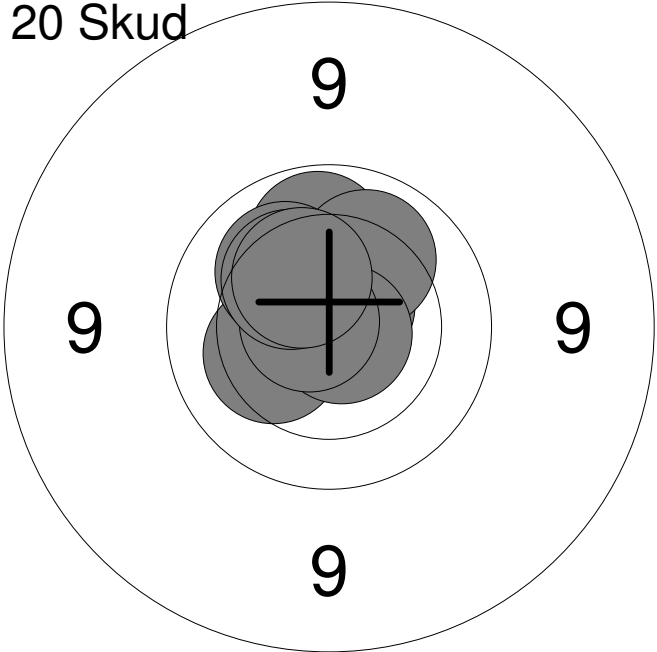
Hold	Skive	Jacob Evans Jensen		
8	2	15m	Skf. Kimbrene	BK1
30.01.2015	Nordjysk mesterskab 2015		Aalborg Skyttekreds	
Prøve		1:	9.8	↙
		2:	10.4	↙
		3:	9.7	↗
		4:	10.6x	↙
		5:	10.5x	↗
		<b>Serie</b>	<b>48.0</b>	
		<b>Total</b>	<b>0.0</b>	
20 Skud		1:	10.8x	↘
		2:	10.4	↗
		3:	10.6x	↗
		4:	10.7x	↗
		5:	10.8x	↗
		6:	9.9	↗
		7:	10.0	↗
		8:	10.5	↗
		9:	10.6x	↗
		10:	10.6x	↙
		<b>Serie</b>	<b>99.0</b>	
		<b>Total</b>	<b>99.0</b>	
20 Skud		11:	10.4	↗
		12:	10.7x	↗
		13:	10.3	↙
		14:	10.0	↗
		15:	10.1	↗
		16:	10.8x	↘
		17:	10.2	↗
		18:	10.7x	↙
		19:	10.3	↗
		20:	10.3	↗
		<b>Serie</b>	<b>100.0</b>	
		<b>Total</b>	<b>199.0</b>	

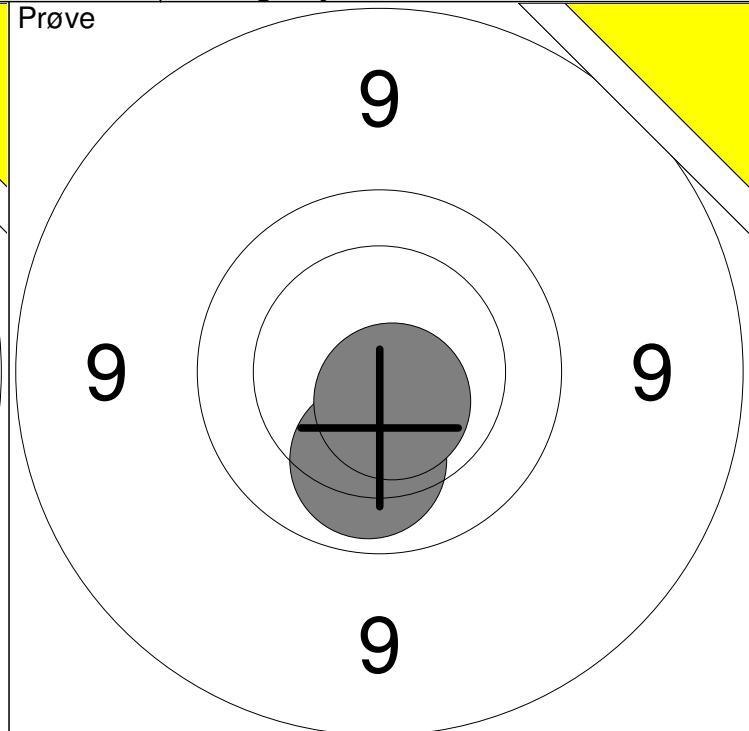
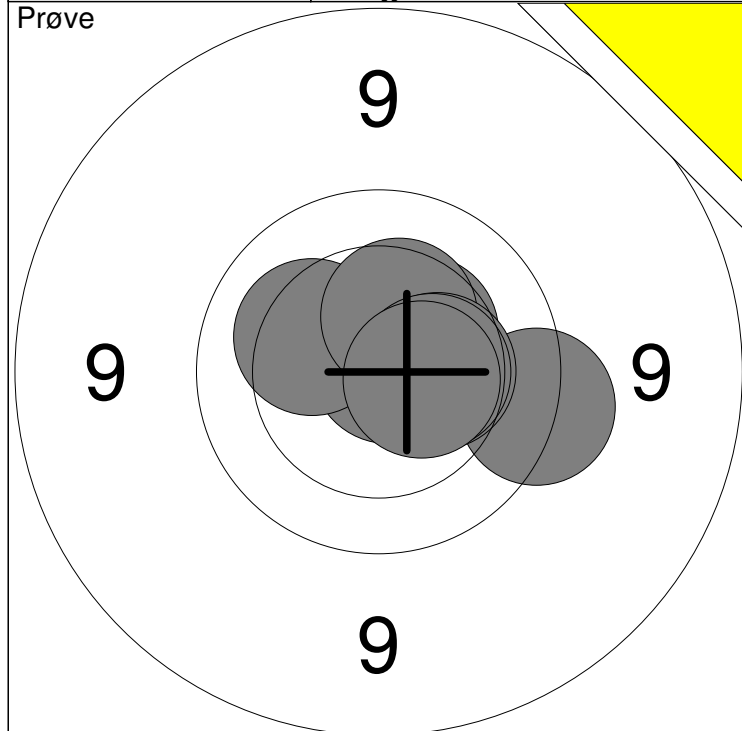

1: 9.6 →	6: 10.2 ↖	Serie	99
2: 10.4 ↗	7: 10.4 ↗		
3: 10.7x ↗	8: 10.4 →	Total	0
4: 10.5x ↗	9: 10.4 →		
5: 10.8x ↗	10: 10.5x →		

11: 10.1 ↓	Serie	20
12: 10.6x ↓		
Total		0

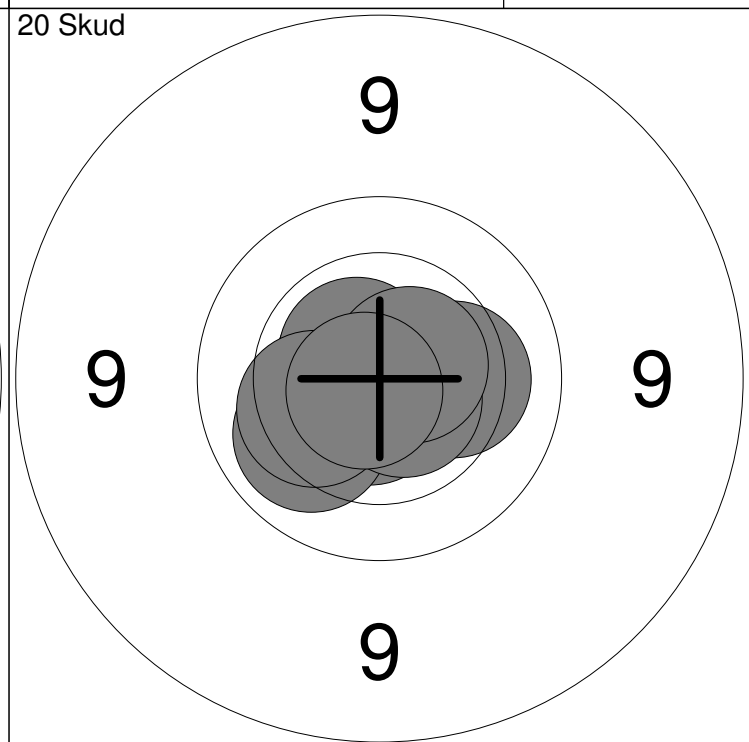
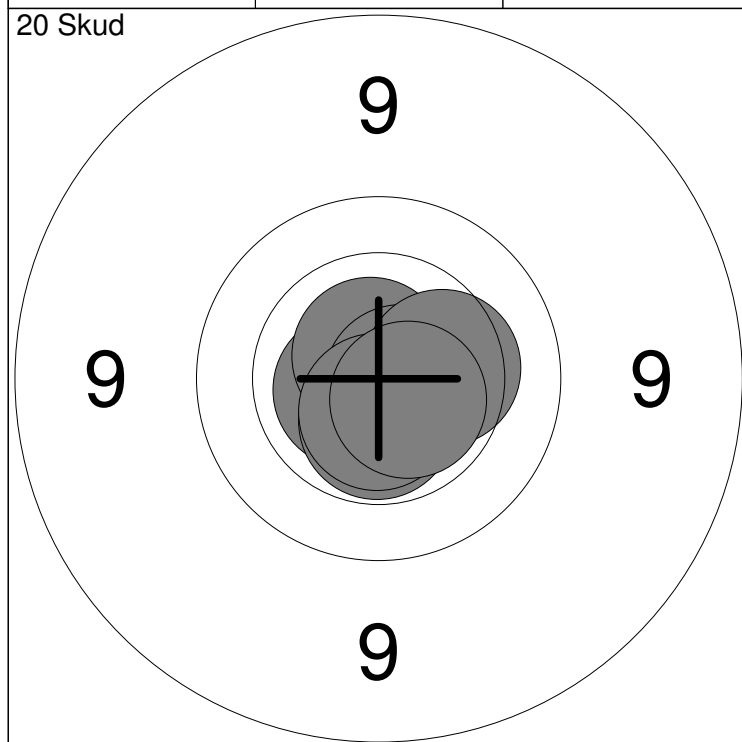

1: 10.7x →	6: 10.7x ↖	Serie	100
2: 10.6x →	7: 10.7x →		
3: 10.7x ←	8: 10.6x ↓	Total	100
4: 10.5x ↓	9: 10.3 →		
5: 10.8x ↘	10: 10.6x ↘		

11: 10.7x ↓	16: 10.6x ↖	Serie	100
12: 10.1 ↖	17: 10.6x ↘		
13: 10.2 →	18: 10.6x ↗	Total	200
14: 10.8x ↓	19: 10.3 ←		
15: 10.7x ↖	20: 10.8x ↘		

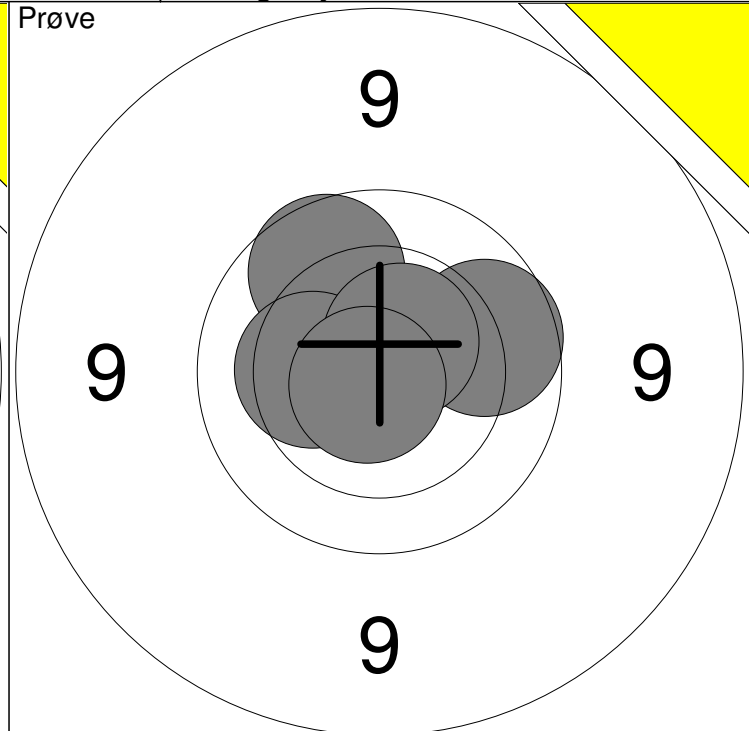
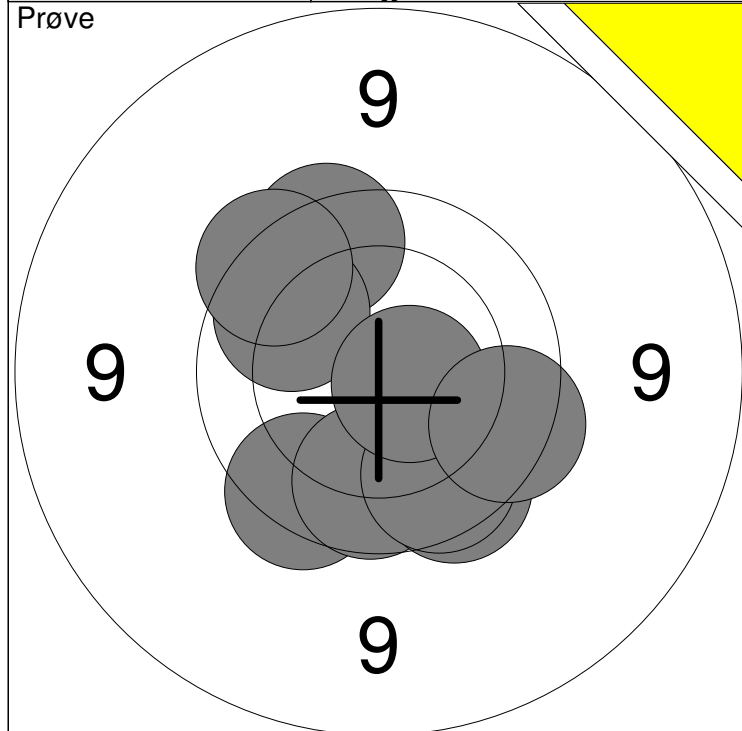

1: 9.7 ↙	6: 9.8 ↗	Serie	92
2: 10.2 ↓	7: 9.9 ↗		
3: 9.9 ↓	8: 10.6x ↓	Total	0
4: 9.8 ↓	9: 9.7 ↗		
5: 9.9 ↓	10: 9.8 ↓		

11: 9.9 ↗	Serie	48
12: 9.9 →		
13: 10.3 ←	Total	0
14: 10.6x ↗		
15: 10.8x ↙		

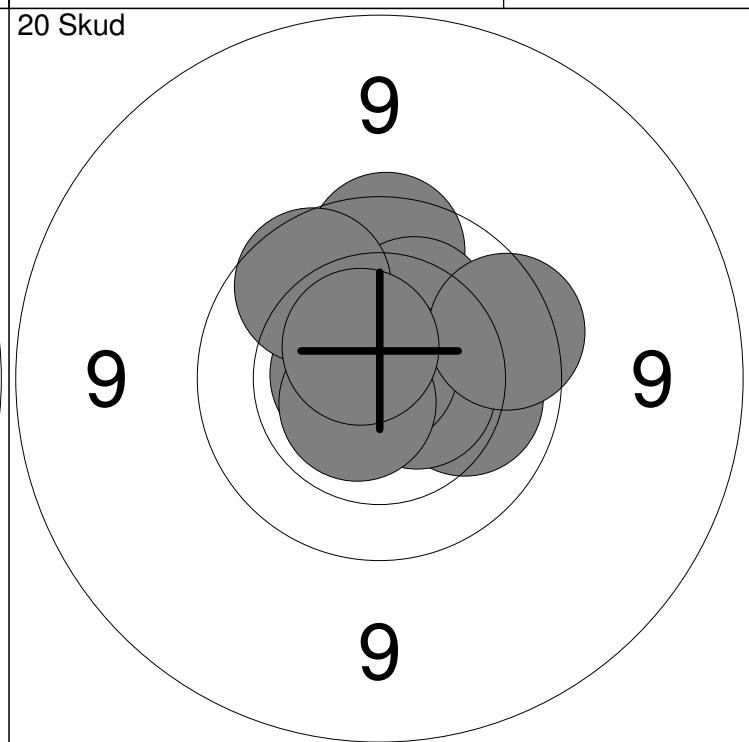
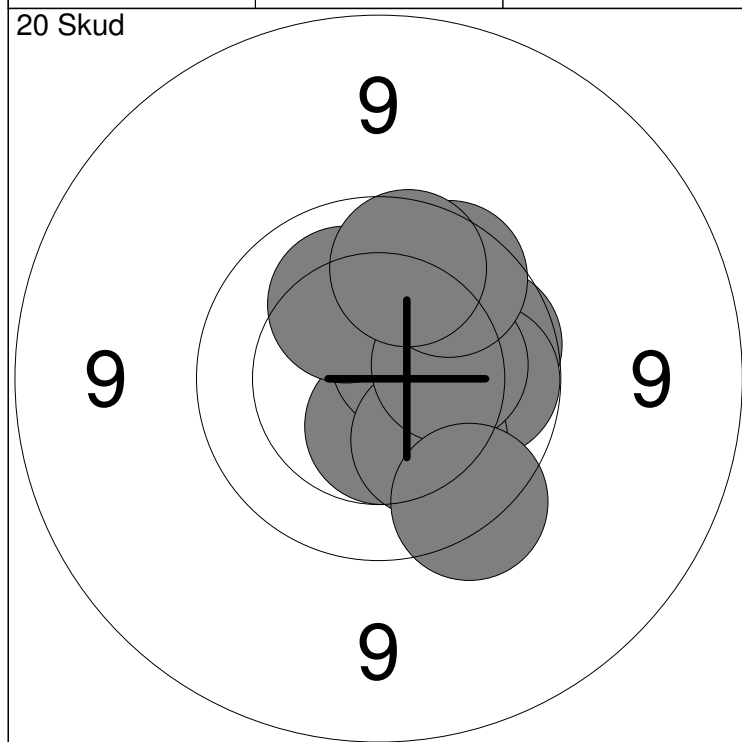

1: 10.5 ↓	6: 10.2 ↗	Serie	96
2: 9.9 →	7: 10.3 →		
3: 10.0 →	8: 9.9 ↗	Total	96
4: 10.6x ↗	9: 9.7 ↓		
5: 10.2 ↓	10: 9.9 ↗		

11: 9.8 ↑	16: 10.7x ←	Serie	97
12: 10.1 →	17: 9.8 →		
13: 10.6x →	18: 10.6x ↙	Total	193
14: 10.2 ↗	19: 9.9 ↗		
15: 10.9x ↑	20: 10.6x ↙		

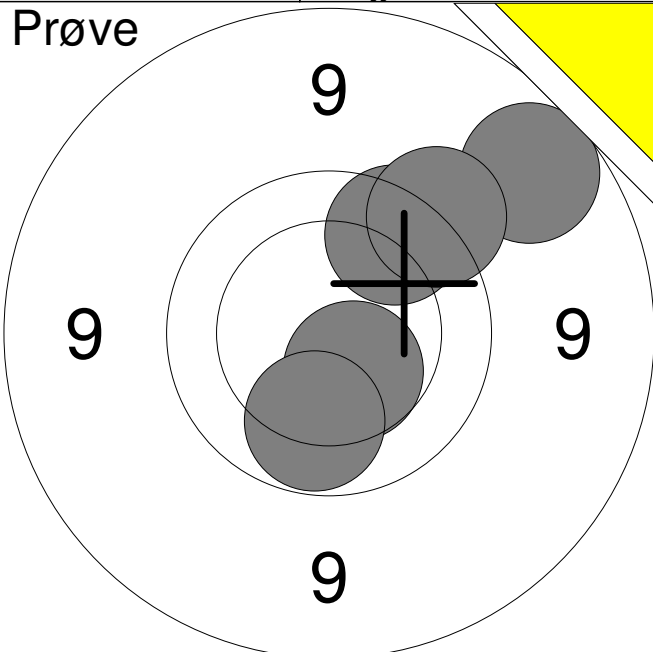
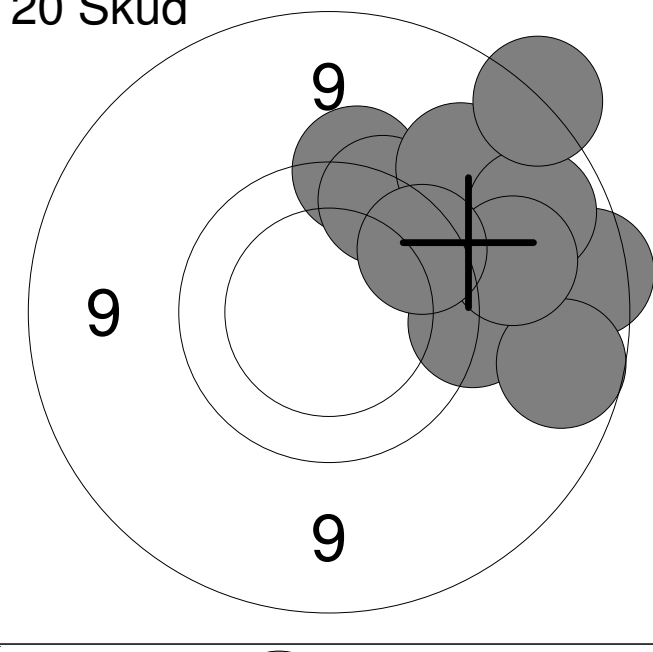
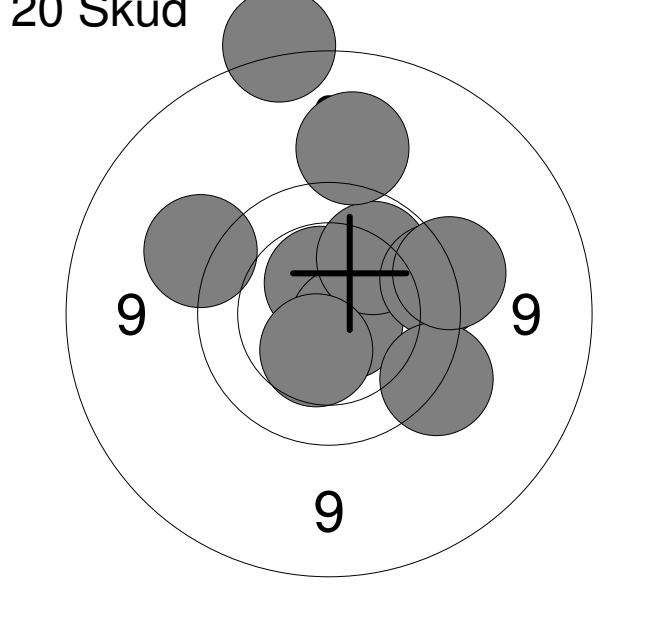
Hold <b>8</b>	Skive <b>5</b>	<b>Nina Nielsen</b>	
15m	Frederikshavn Skyttekreds	J2	
30.01.2015	Nordjysk mesterskab 2015	Aalborg Skyttekreds	
Prøve		1: 8.9 ↗	
		2: 10.5 ↓	
		3: 9.8 ↗	
		4: 10.0 ↓	
		5: 9.5 ↗	
	Serie	46.0	
	Total	0.0	
20 Skud		1: 9.6 ↑	
		2: 9.7 ↗	
		3: 9.2 ↗	
		4: 9.6 →	
		5: 8.8 →	
		6: 9.0 ↗	
		7: 8.7 ↗	
		8: 8.9 →	
		9: 9.3 →	
		10: 9.8 ↗	
	Serie	87.0	
	Total	87.0	
20 Skud		11: 8.6 ↑	
		12: 10.5x ↑	
		13: 10.7x →	
		14: 10.0 ↗	
		15: 10.4 ↓	
		16: 9.2 ↑	
		17: 9.7 →	
		18: 9.6 ↓	
		19: 9.6 →	
		20: 9.4 ←	
	Serie	93.0	
	Total	180.0	

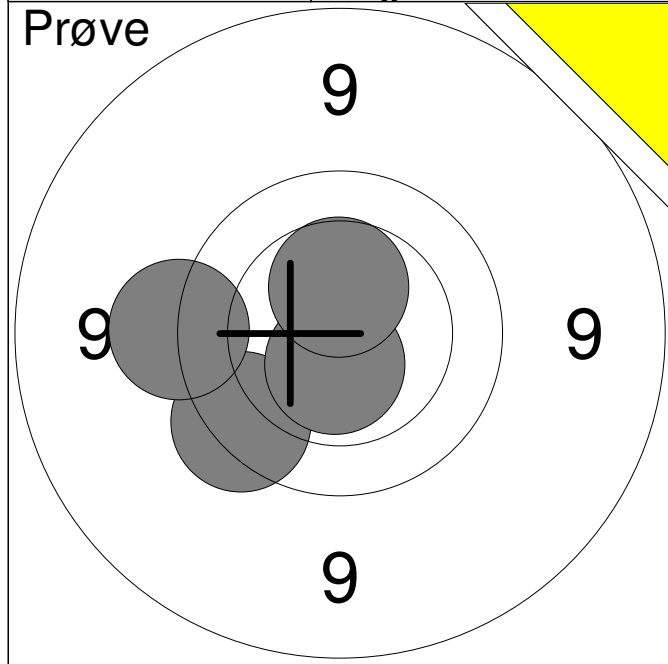

1:	9.7	↙
2:	9.5	←
3:	10.6x	↓
4:	10.5	↑
<b>Serie</b>	<b>38.0</b>	
<b>Total</b>	<b>0.0</b>	

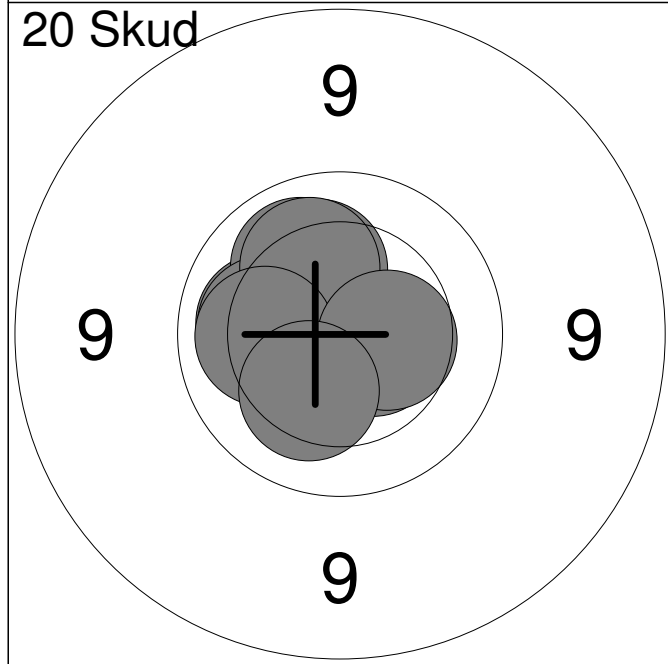

1:	10.1	←
2:	10.1	↗
3:	10.6x	→
4:	10.2	←
5:	10.8x	↓
6:	10.2	↗
7:	10.2	↗
8:	10.1	←
9:	10.4	→
10:	10.3	↙
<b>Serie</b>	<b>100.0</b>	
<b>Total</b>	<b>100.0</b>	

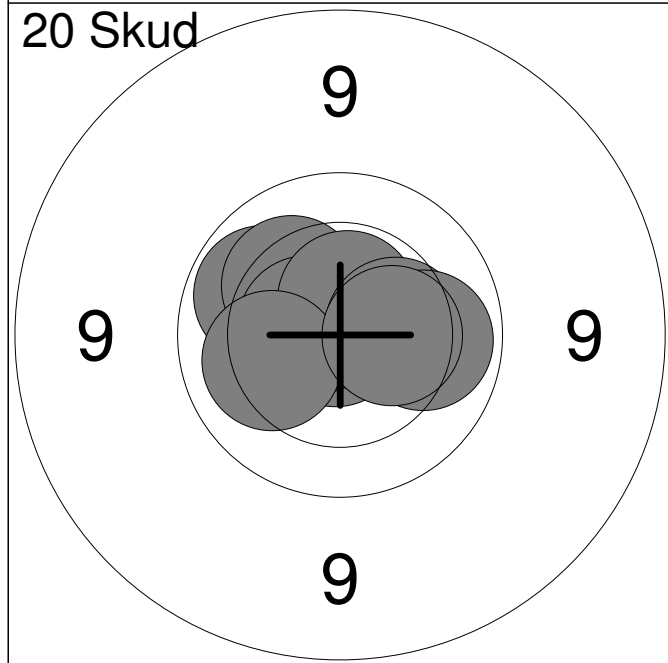

11:	10.9x	←
12:	10.7x	↗
13:	10.0	↗
14:	10.2	↗
15:	10.6x	←
16:	10.6x	↑
17:	10.3	→
18:	10.2	←
19:	10.0	→
20:	10.4	→
<b>Serie</b>	<b>100.0</b>	
<b>Total</b>	<b>200.0</b>	

Hold <b>8</b>	Skive <b>9</b>	<b>Lucas Friberg</b>	
------------------	-------------------	----------------------	--

15m	Hjørring Skytteforening	BK3
-----	-------------------------	-----

30.01.2015	Nordjysk mesterskab 2015	Aalborg Skyttekreds
------------	--------------------------	---------------------

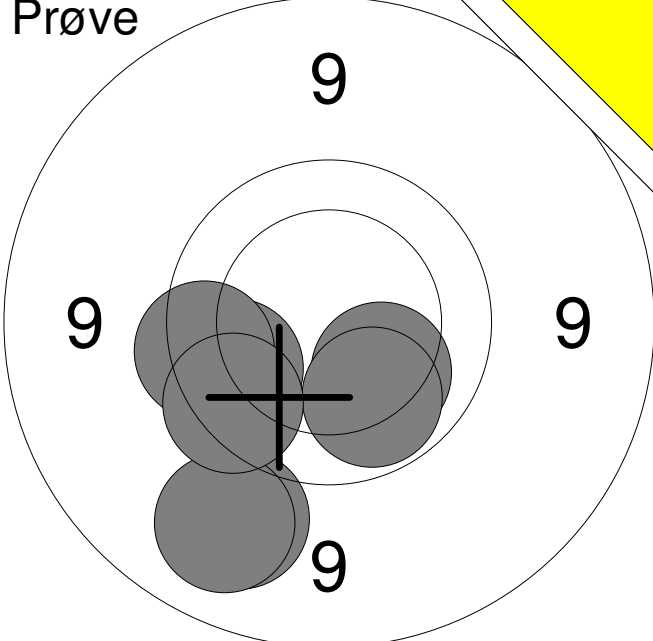
<b>Prøve</b> 	1:	10.2	↘
	2:	9.2	↘
	3:	9.9	↙
	4:	10.0	↘
	5:	9.1	↘
	6:	9.7	↙
	7:	9.7	↘
	<b>Serie</b>		
<b>Total</b>			<b>0.0</b>

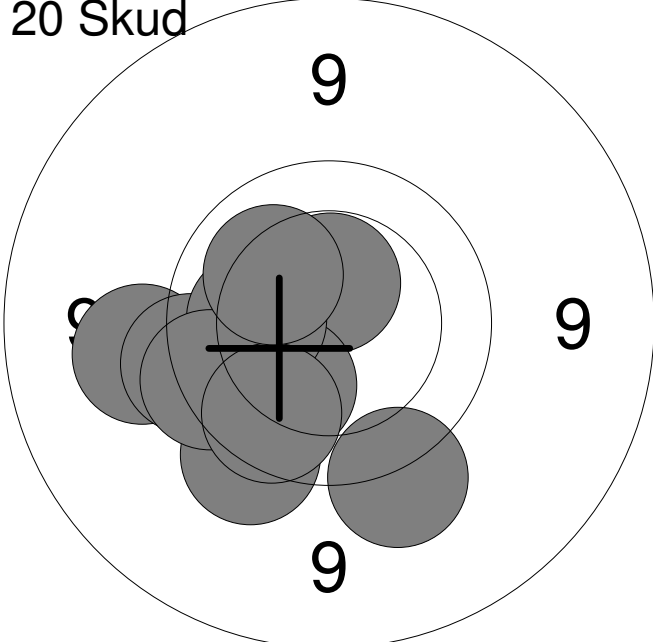
<b>20 Skud</b> 	1:	9.5	↘
	2:	9.6	↘
	3:	10.5x	↑
	4:	10.1	↘
	5:	9.4	↙
	6:	9.6	↙
	7:	10.2	↙
	8:	9.7	↙
	9:	9.9	↘
	10:	10.2	↘
	<b>Serie</b>		
<b>Total</b>			<b>94.0</b>

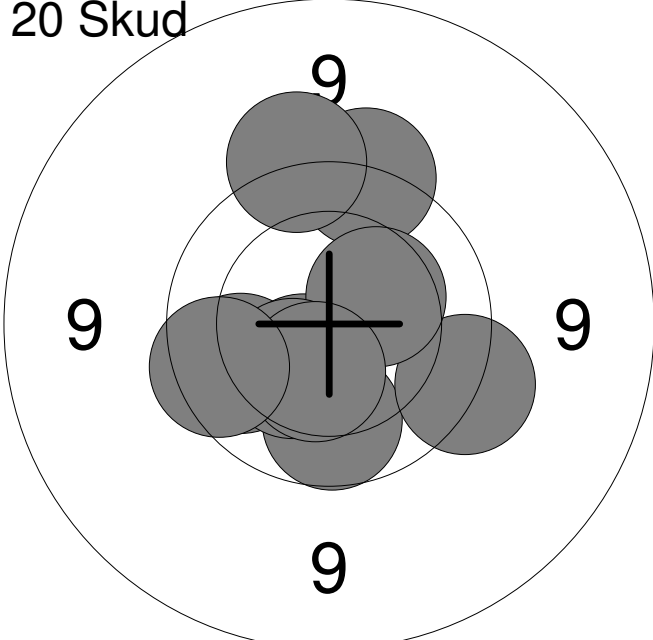
<b>20 Skud</b> 	11:	9.9	↙
	12:	9.9	↘
	13:	9.6	↘
	14:	9.6	↑
	15:	9.5	↑
	16:	10.4	↘
	17:	10.4	↗
	18:	10.3	↘
	19:	10.4	↘
	20:	9.8	↙
	<b>Serie</b>		
<b>Total</b>			<b>188.0</b>

Hold <b>8</b>	Skive <b>10</b>	<b>Filip Friberg Nielsen</b>	
------------------	--------------------	------------------------------	--

15m	Hjørring Skytteforening	BK1
-----	-------------------------	-----

30.01.2015	Nordjysk mesterskab 2015	Aalborg Skyttekreds
------------	--------------------------	---------------------

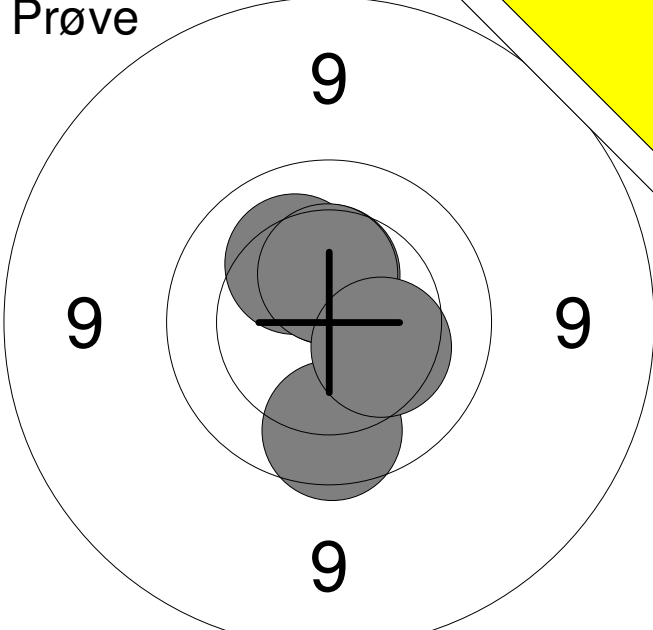
<b>Prøve</b> 	1: 9.9	↓
	2: 10.4	↑
	3: 10.2	↗
	4: 10.4	↑
	5: 10.3	↘
	<b>Serie</b>	<b>49.0</b>
	<b>Total</b>	<b>0.0</b>

<b>20 Skud</b> 	1: 10.4	←
	2: 10.3	↗
	3: 10.8x	↙
	4: 10.4	↓
	5: 10.2	↗
	6: 10.0	↓
	7: 9.8	↓
	8: 9.7	↓
	9: 10.4	↓
	10: 10.0	↗
	<b>Serie</b>	<b>98.0</b>
	<b>Total</b>	<b>98.0</b>

<b>20 Skud</b> 	11: 10.6x	↓
	12: 10.3	←
	13: 10.1	↘
	14: 10.5x	→
	15: 10.5x	↗
	16: 9.9	↙
	17: 10.3	↗
	18: 10.5x	↘
	19: 10.3	←
	20: 10.6x	↓
	<b>Serie</b>	<b>99.0</b>
	<b>Total</b>	<b>197.0</b>



Hold <b>8</b>	Skive <b>11</b>	<b>Victor D. Mortensen</b>
------------------	--------------------	----------------------------

15m	Hjørring Skytteforening	BK3
-----	-------------------------	-----

30.01.2015	Nordjysk mesterskab 2015	Aalborg Skyttekreds
------------	--------------------------	---------------------

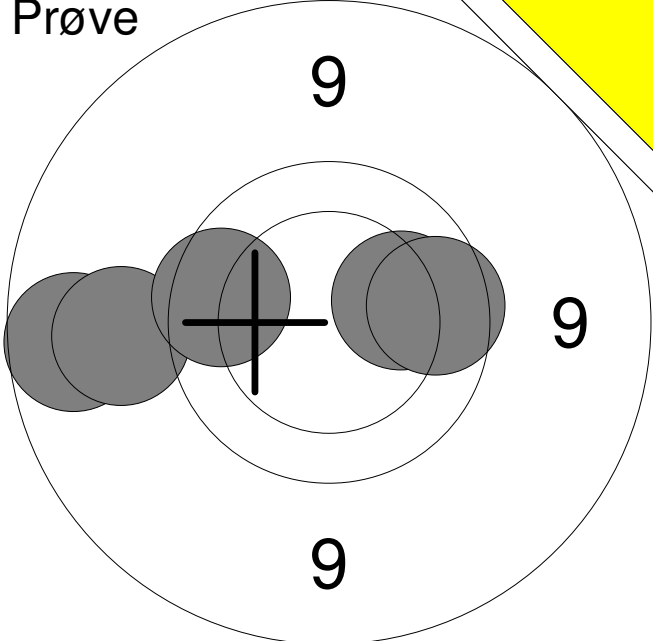
<b>Prøve</b> 	1: 10.1 →
	2: 8.9 ←
	3: 9.2 ←
	4: 9.8 ←
	5: 9.9 →
<b>Serie</b>	<b>45.0</b>
<b>Total</b>	<b>0.0</b>

<b>20 Skud</b> 	1: 9.7 ↗
	2: 9.1 →
	3: 10.7x ↗
	4: 10.3 ↙
	5: 10.6x →
	6: 10.5 ↓
	7: 9.7 ↘
	8: 10.6x →
	9: 9.7 ↙
	10: 9.6 ↓
<b>Serie</b>	<b>95.0</b>
<b>Total</b>	<b>95.0</b>

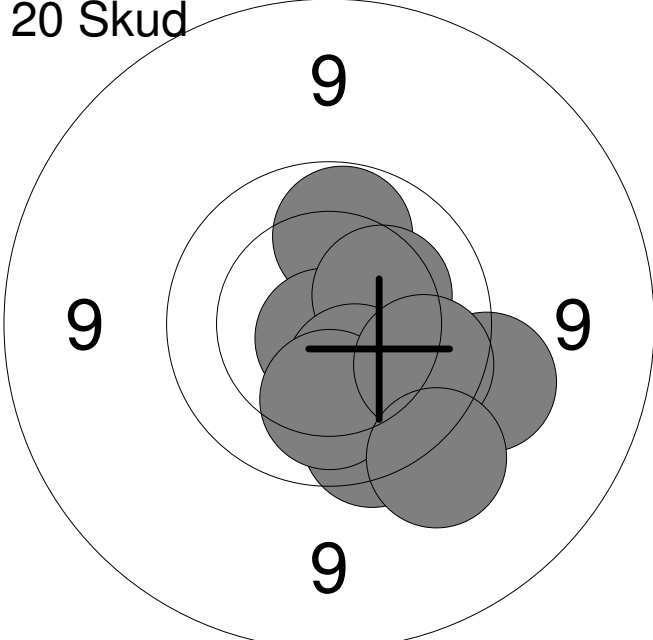
<b>20 Skud</b> 	11: 10.0 ↑
	12: 10.5x →
	13: 10.8x ↓
	14: 9.5 →
	15: 10.3 ↗
	16: 10.3 ↘
	17: 9.8 ↘
	18: 10.1 ↓
	19: 9.9 ↘
	20: 9.5 ↓
<b>Serie</b>	<b>96.0</b>
<b>Total</b>	<b>191.0</b>

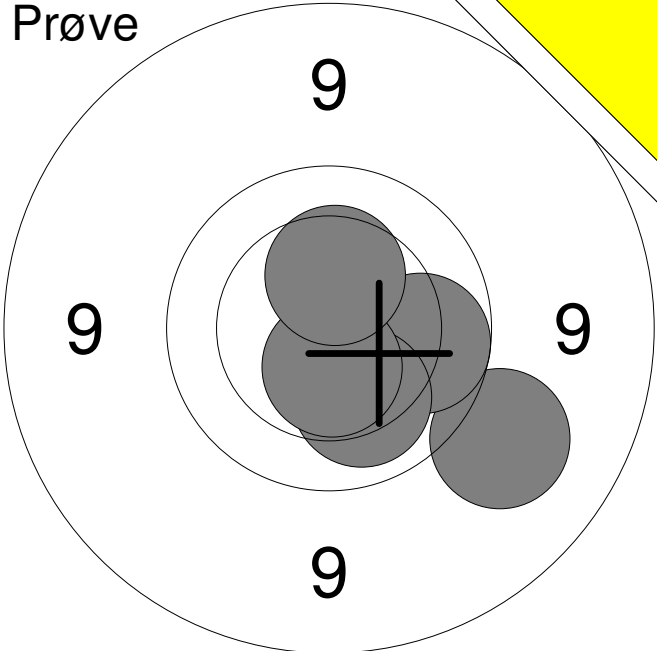
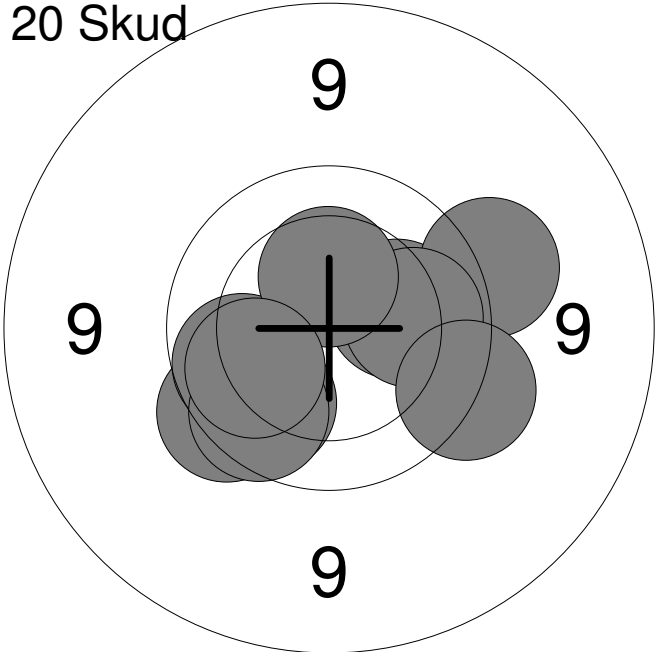
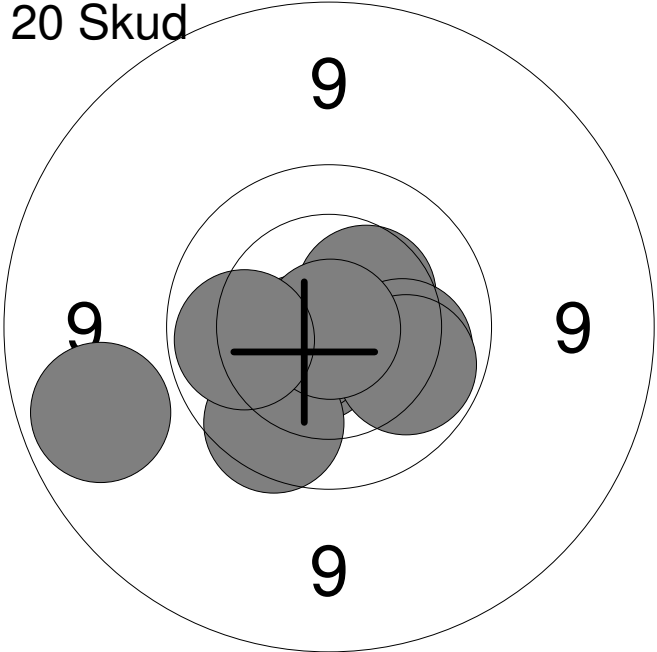
Hold	Skive	Morten Christian Pedersen	
8	12		
15m	Hjørring Skytteforening	BK3	
30.01.2015	Nordjysk mesterskab 2015	Aalborg Skyttekreds	
Prøve		1: 9.3 ↘	
		2: 9.9 →	
		3: 10.1 ↘	
		4: 10.5x ↓	
		5: 10.4 ↑	
	Serie	48.0	
	Total	0.0	
20 Skud		1: 10.2 →	
		2: 9.9 ↘	
		3: 9.7 ↘	
		4: 9.5 →	
		5: 10.0 →	
		6: 9.9 ←	
		7: 9.8 ↘	
		8: 9.6 →	
		9: 10.4 ↑	
		10: 10.0 ↘	
	Serie	94.0	
	Total	94.0	
20 Skud		11: 10.4 ↗	
		12: 10.1 →	
		13: 9.0 ←	
		14: 10.6x ↘	
		15: 10.4 ↘	
		16: 10.6x ↘	
		17: 9.8 ↘	
		18: 10.0 →	
		19: 10.9x ↘	
		20: 10.0 ←	
	Serie	98.0	
	Total	192.0	

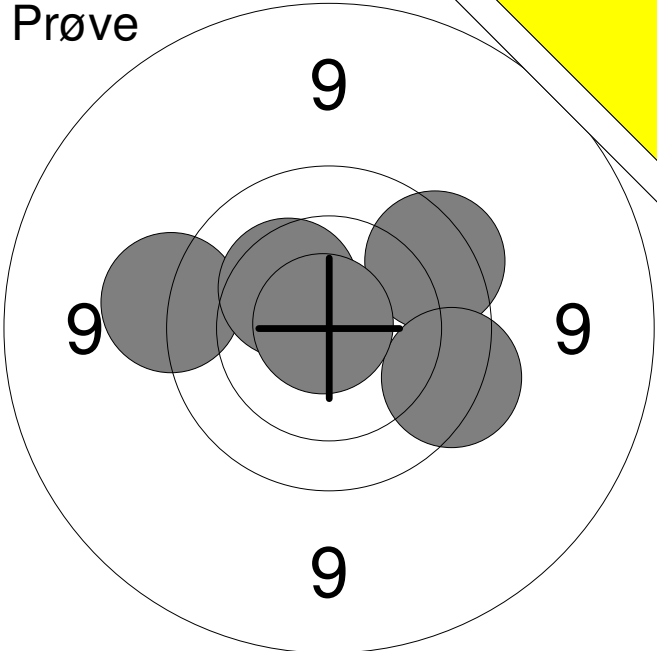
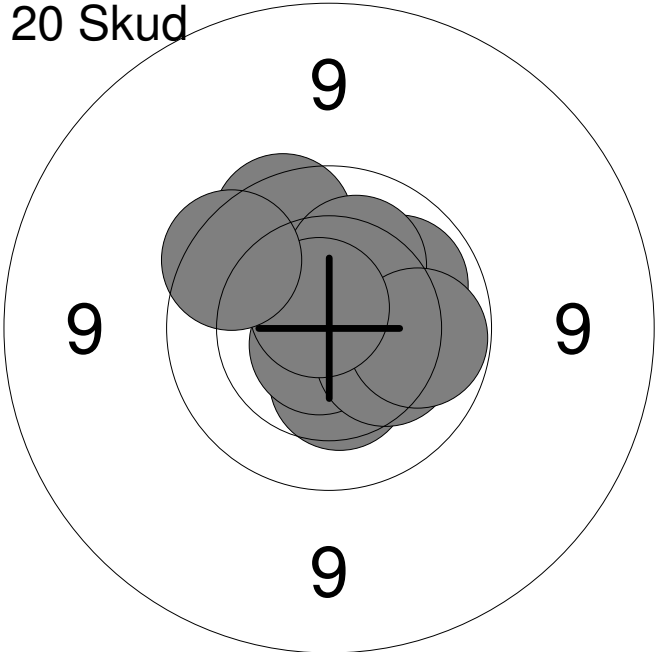
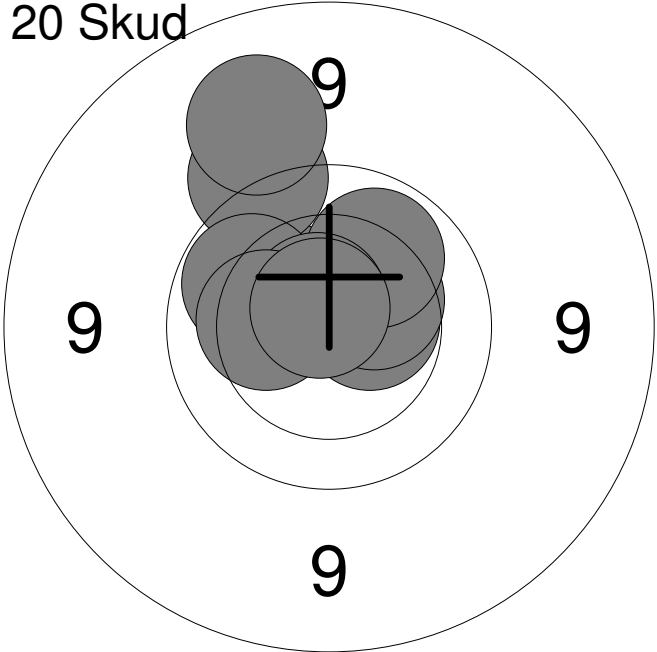
Hold	Skive	Natalie Dahl	
9	1	15m	Skf. Kimbrene J2
30.01.2015	Nordjysk mesterskab 2015	Aalborg Skyttekreds	
Prøve		1: 9.5 ←	
		2: 9.7 ↗	
		3: 9.7 ↘	
		4: 10.3 ↗	
		5: 10.9x ↗	
	Serie	47.0	
	Total	0.0	
20 Skud		1: 10.8x ↗	
		2: 9.8 ↗	
		3: 10.1 ↗	
		4: 10.2 ↗	
		5: 10.4 ↓	
		6: 10.7x ↓	
		7: 10.3 ↘	
		8: 10.0 →	
		9: 10.7x ↗	
		10: 9.8 ↗	
	Serie	98.0	
	Total	98.0	
20 Skud		11: 10.4 ↗	
		12: 9.5 ↗	
		13: 10.0 ↗	
		14: 10.5x →	
		15: 9.2 ↗	
		16: 10.4 ↗	
		17: 10.1 ↗	
		18: 10.7x ↗	
		19: 10.3 ←	
		20: 10.7x ↗	
	Serie	98.0	
	Total	196.0	

Hold	Skive	Thomas Pohl		
9	2	15m	Skf. Kimbrene	BK2
30.01.2015	Nordjysk mesterskab 2015		Aalborg Skyttekreds	
Prøve		1:	10.1	↗
		2:	10.0	↓
		3:	10.2	→
		4:	10.0	↗
		5:	10.1	←
		<b>Serie</b>	<b>50.0</b>	
		<b>Total</b>	<b>0.0</b>	
20 Skud		1:	10.4	←
		2:	10.6x	↙
		3:	9.8	↓
		4:	10.1	↑
		5:	10.3	→
		6:	10.4	↙
		7:	9.9	↙
		8:	10.4	↗
		9:	9.5	←
		10:	10.1	←
		<b>Serie</b>	<b>97.0</b>	
		<b>Total</b>	<b>97.0</b>	
20 Skud		11:	9.8	↓
		12:	10.0	→
		13:	10.6x	↑
		14:	10.3	↙
		15:	10.2	←
		16:	9.7	↓
		17:	10.9x	↙
		18:	9.6	↙
		19:	10.0	↓
		20:	9.9	↙
		<b>Serie</b>	<b>96.0</b>	
		<b>Total</b>	<b>193.0</b>	

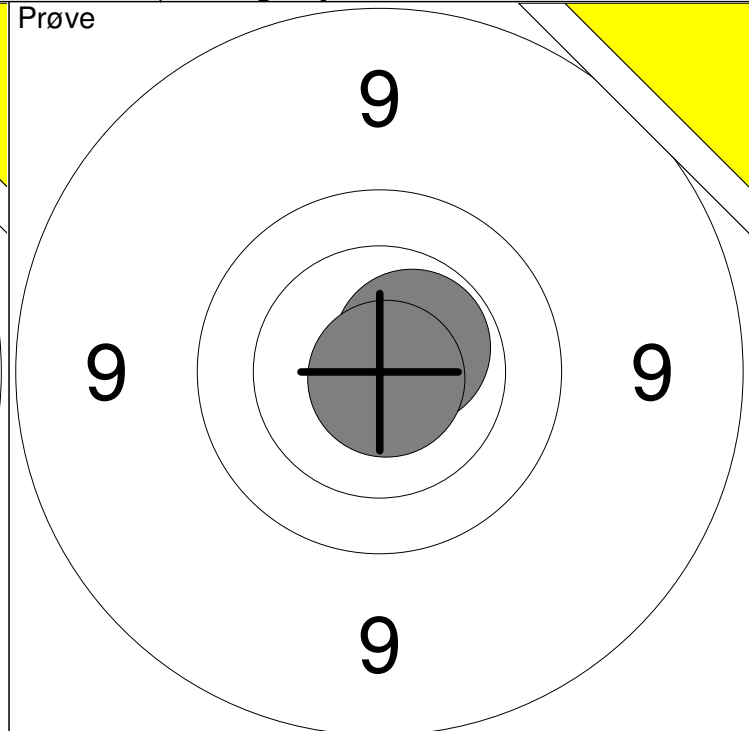
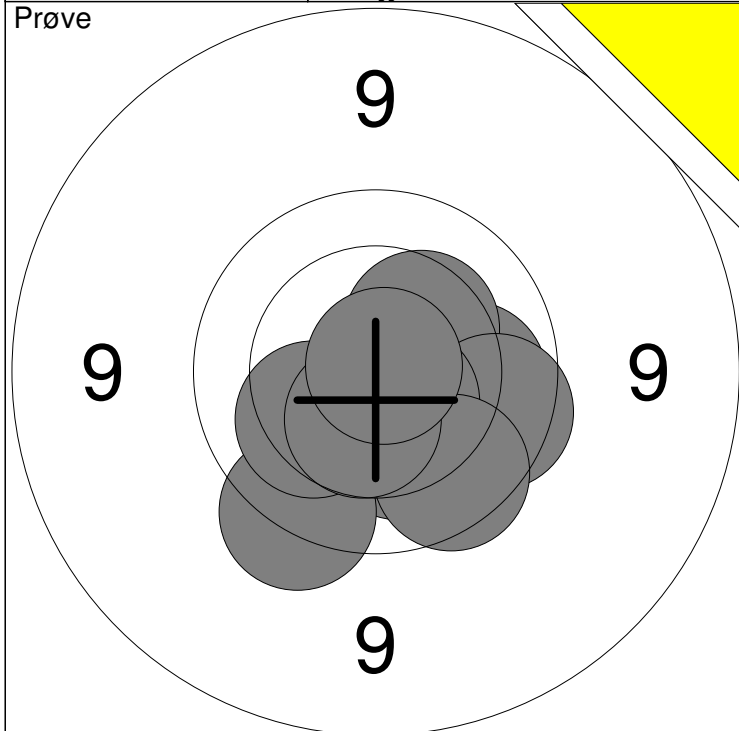

1: 10.0 →	6: 9.6 ↙	Serie	97
2: 10.2 ↓	7: 10.2 ↙		
3: 10.3 ↗	8: 9.8 ↓	Total	0
4: 9.8 →	9: 10.5 ↓		
5: 10.6x ↓	10: 10.9x ↗		

11: 10.6x ↗	Serie	20
12: 10.9x ↓		
Total		0

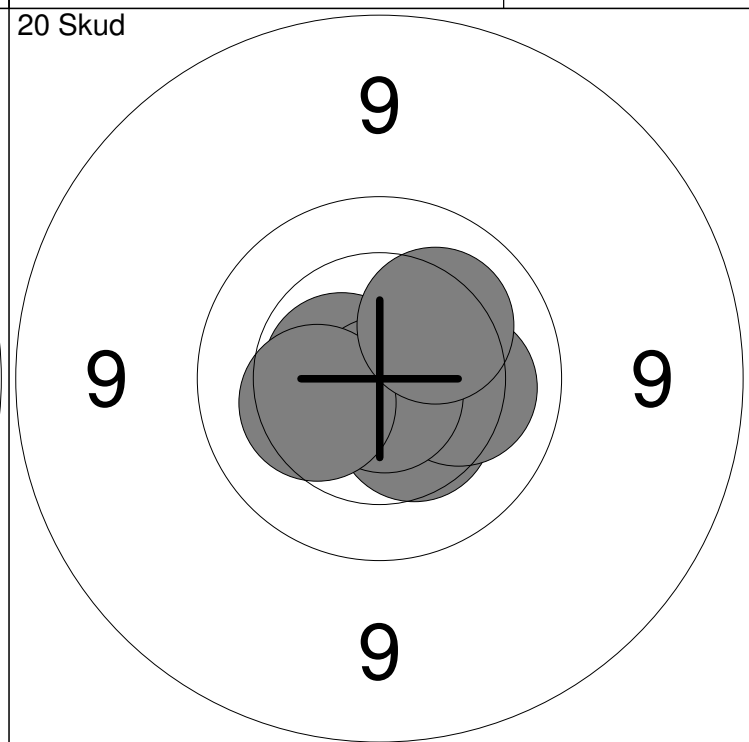
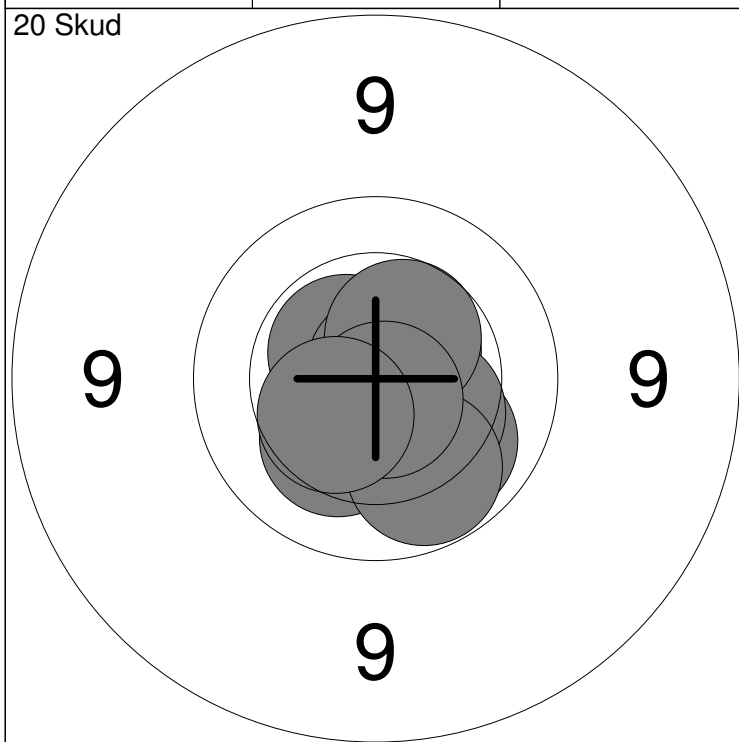

1: 10.1 ↓	6: 10.4 ↓	Serie	100
2: 10.6x ↗	7: 10.0 ↓		
3: 10.3 ↓	8: 10.5 ↗	Total	100
4: 10.8x ↗	9: 10.7x ↓		
5: 10.6x ↗	10: 10.4 ↙		

11: 10.3 →	16: 10.2 →	Serie	100
12: 10.8x ↗	17: 10.6x ←		
13: 10.6x ↗	18: 10.8x ↓	Total	200
14: 10.5 →	19: 10.3 ←		
15: 10.4 ↓	20: 10.2 ↗		

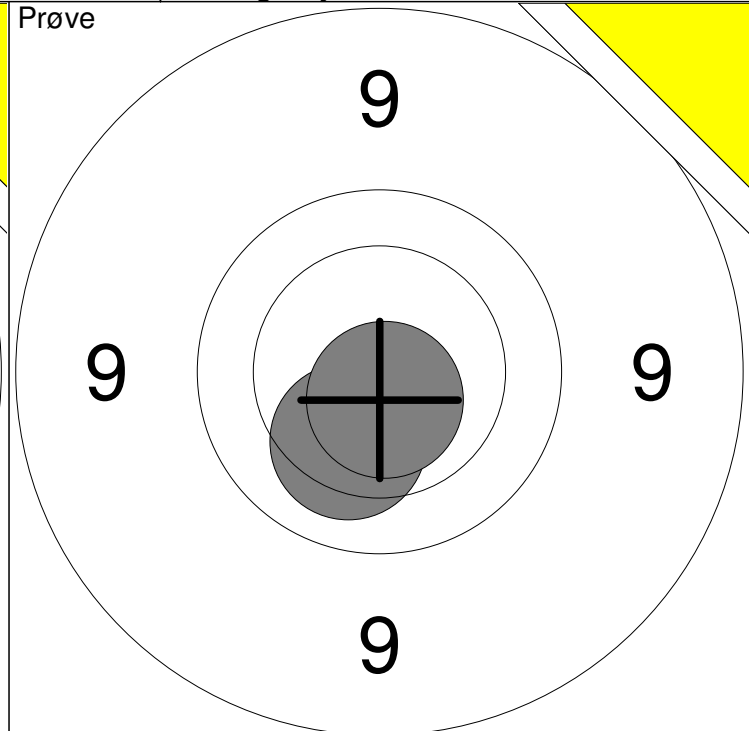
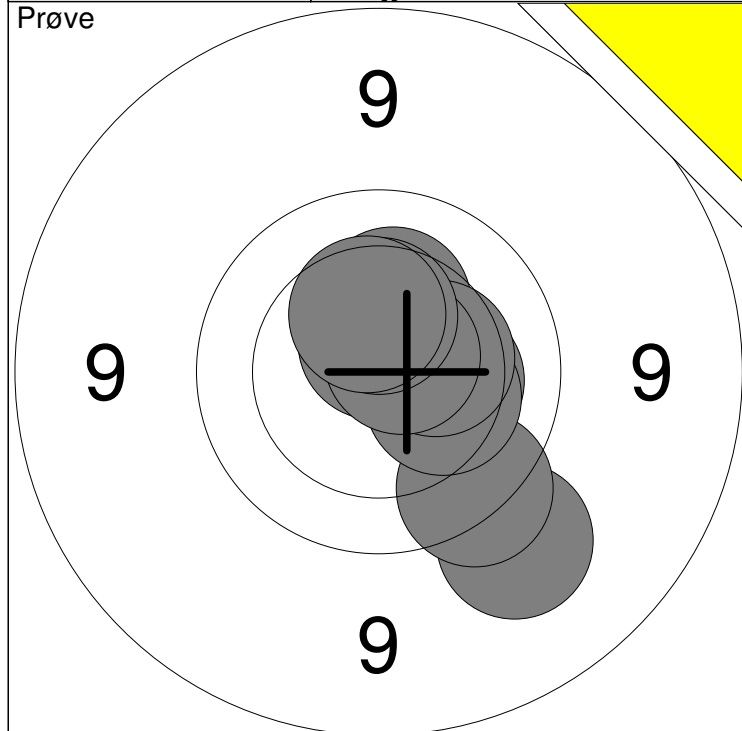

1: 9.3 ↘	6: 10.4 →	Serie	98
2: 9.7 ↘	7: 10.7x ↑		
3: 10.3 →	8: 10.7x ↗	Total	0
4: 10.3 ↘	9: 10.4 ↑		
5: 10.3 ↑	10: 10.4 ↑		

11: 10.2 ↘	Serie	20
12: 10.7x ↘		
Total		0

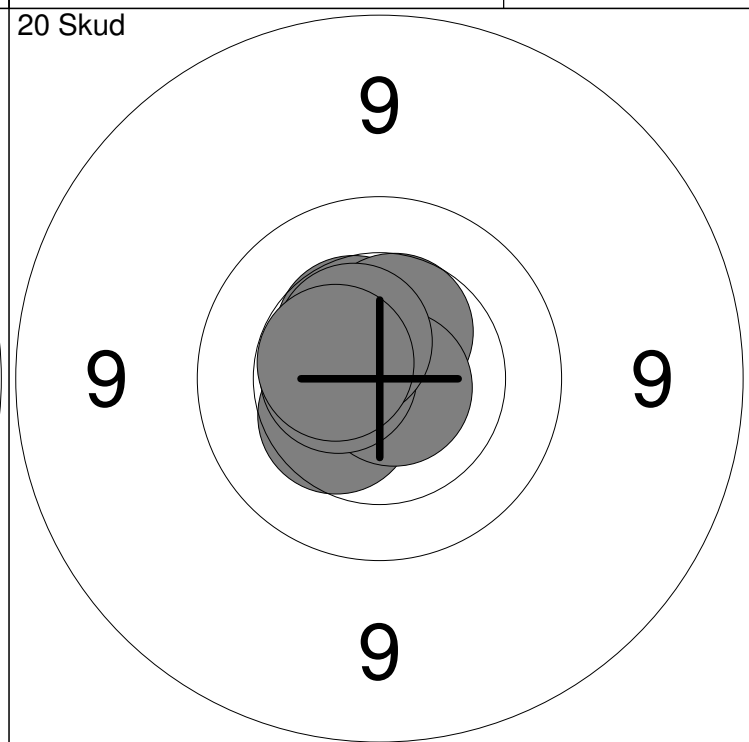
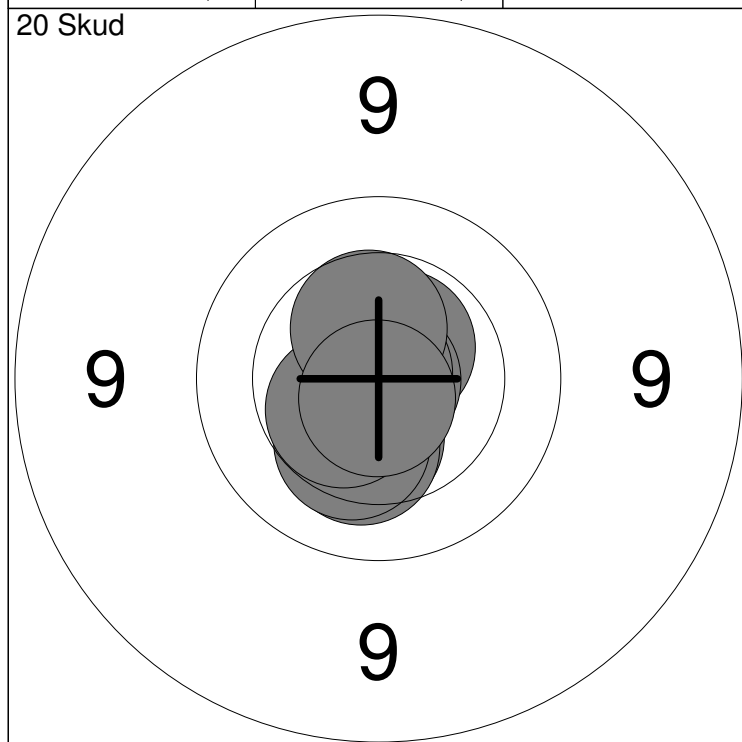

1: 10.4 ↓	6: 10.6x ↙	Serie	100
2: 10.3 ↓	7: 10.3 ↓		
3: 10.6x ↗	8: 10.5x ↙	Total	100
4: 10.9x →	9: 10.5 ↑		
5: 10.9x ↖	10: 10.8x ↓		

11: 10.5 ↖	16: 10.4 ↙	Serie	100
12: 10.6x ↖	17: 10.8x ↘		
13: 10.8x ↙	18: 10.6x ←	Total	200
14: 10.5 ↑	19: 10.5x ↖		
15: 10.9x ↙	20: 10.5x ←		

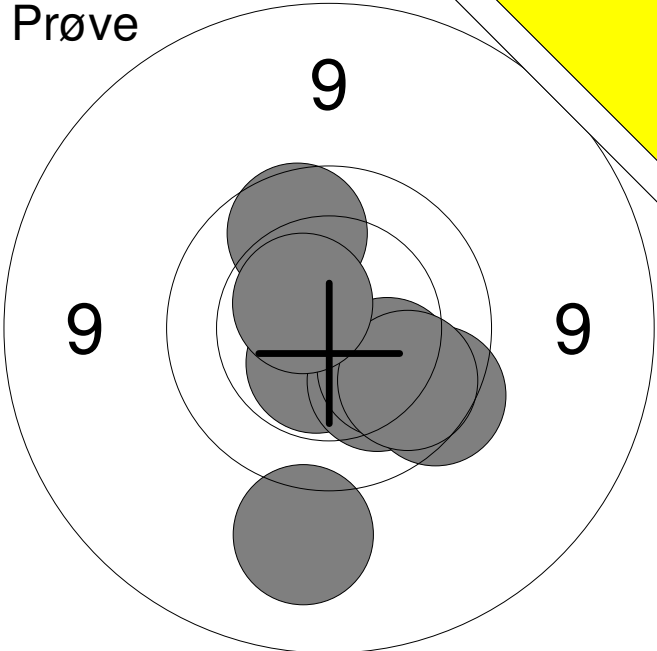
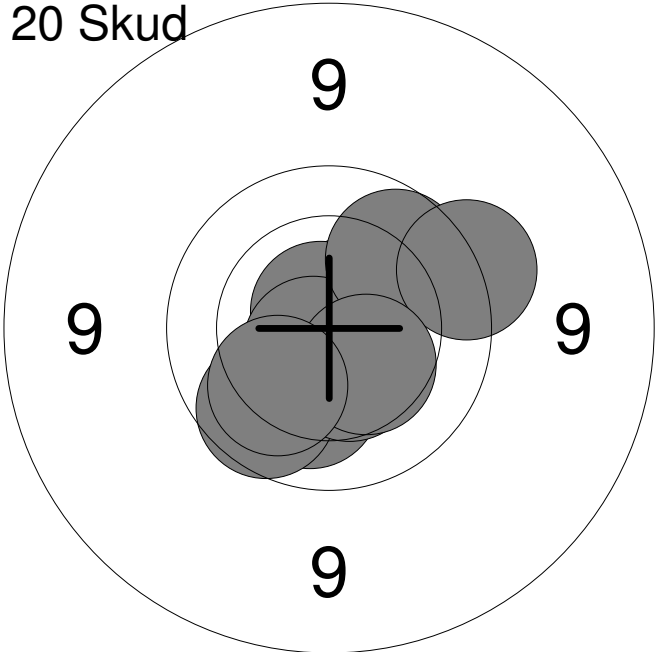
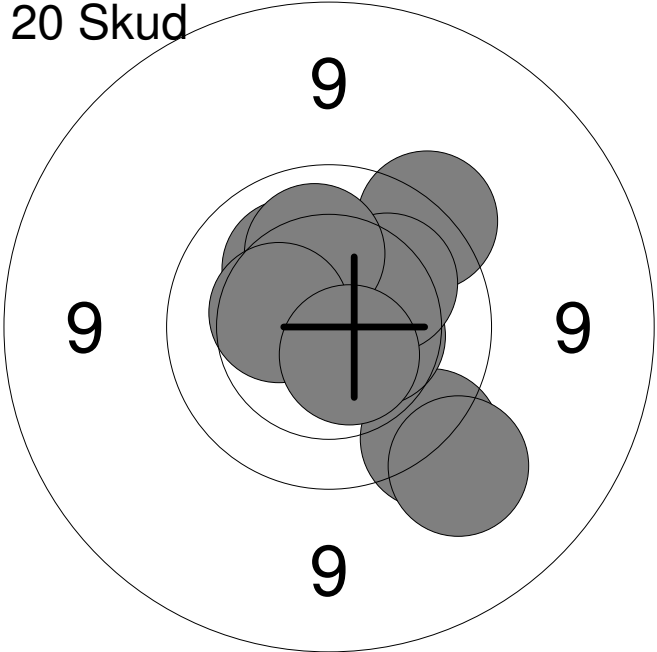
Hold	Skive	Lukas Haldrup	
9	5	Løgstør Sportsskytteklub	BK4
15m			
30.01.2015	Nordjysk mesterskab 2015	Aalborg Skyttekreds	
Prøve		1: 9.2	↓
		2: 10.6x	↓
		3: 10.2	↓
		4: 9.9	↗
		5: 9.7	↓
		6: 10.2	↓
		7: 9.9	↓
		8: 10.6x	↗
		<b>Serie</b>	<b>76.0</b>
		<b>Total</b>	<b>0.0</b>
20 Skud		1: 10.2	↓
		2: 10.6x	↗
		3: 10.7x	↗
		4: 9.9	↓
		5: 10.4	↓
		6: 10.7x	↓
		7: 9.9	↗
		8: 9.6	↗
		9: 10.4	↓
		10: 10.1	↓
		<b>Serie</b>	<b>97.0</b>
		<b>Total</b>	<b>97.0</b>
20 Skud		11: 10.5x	→
		12: 9.6	↓
		13: 10.4	→
		14: 9.6	↗
		15: 10.2	↗
		16: 10.2	↗
		17: 9.4	↓
		18: 10.1	↗
		19: 10.4	↖
		20: 10.6x	↓
		<b>Serie</b>	<b>97.0</b>
		<b>Total</b>	<b>194.0</b>

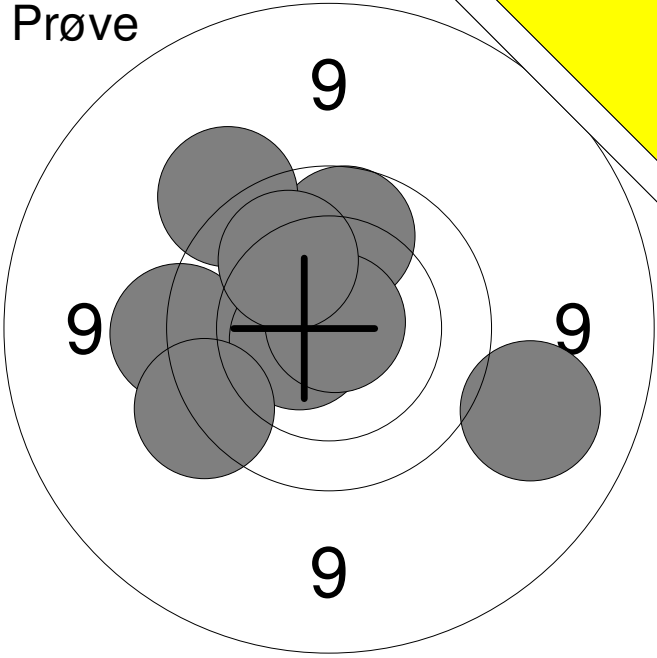
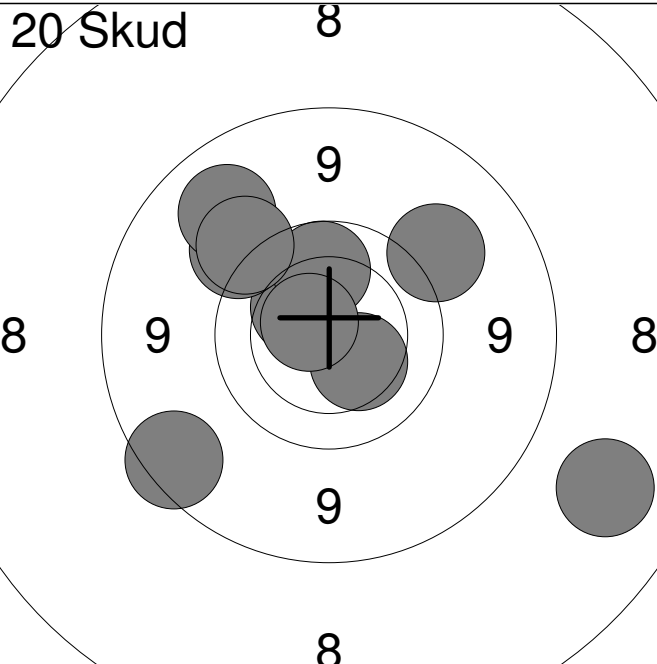
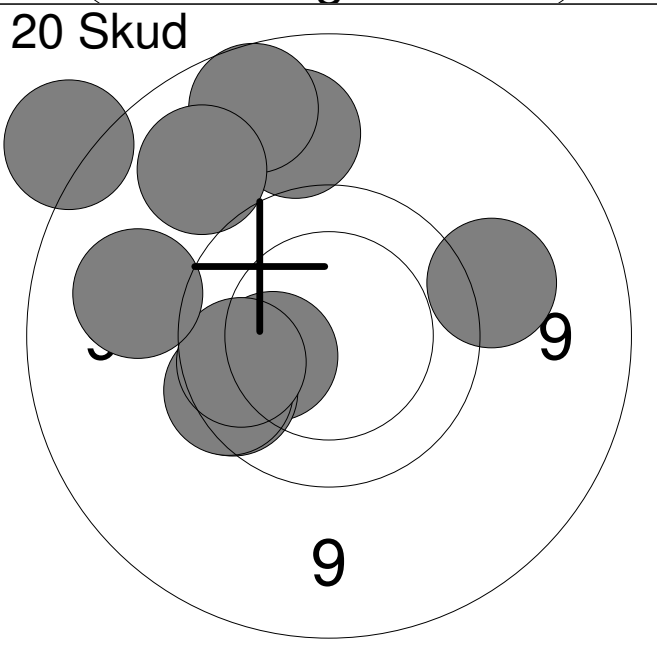
Hold	Skive	Tobias Jørgensen	
9	6	15m	Sæby og Omegns Skytteforening BK4
30.01.2015	Nordjysk mesterskab 2015	Aalborg Skyttekreds	
Prøve		1: 9.6 ←	
		2: 9.9 ↑	
		3: 10.6x ←	
		4: 9.6 ←	
		5: 9.2 →	
		6: 10.9x →	
		7: 9.5 ↗	
		8: 10.1 ↗	
		<b>Serie</b>	<b>75.0</b>
		<b>Total</b>	<b>0.0</b>
20 Skud		1: 10.3 ↗	
		2: 10.3 ↘	
		3: 9.4 ↗	
		4: 8.8 ←	
		5: 9.9 ↑	
		6: 8.2 ↘	
		7: 9.3 ↗	
		8: 9.1 ↗	
		9: 9.4 ↗	
		10: 10.6x ↗	
		<b>Serie</b>	<b>91.0</b>
		<b>Total</b>	<b>91.0</b>
20 Skud		11: 10.3 ←	
		12: 9.8 ←	
		13: 9.8 ←	
		14: 9.2 ↑	
		15: 8.9 ↑	
		16: 9.4 →	
		17: 9.9 ←	
		18: 9.2 ←	
		19: 9.1 ↗	
		20: 8.6 ↗	
		<b>Serie</b>	<b>89.0</b>
		<b>Total</b>	<b>180.0</b>



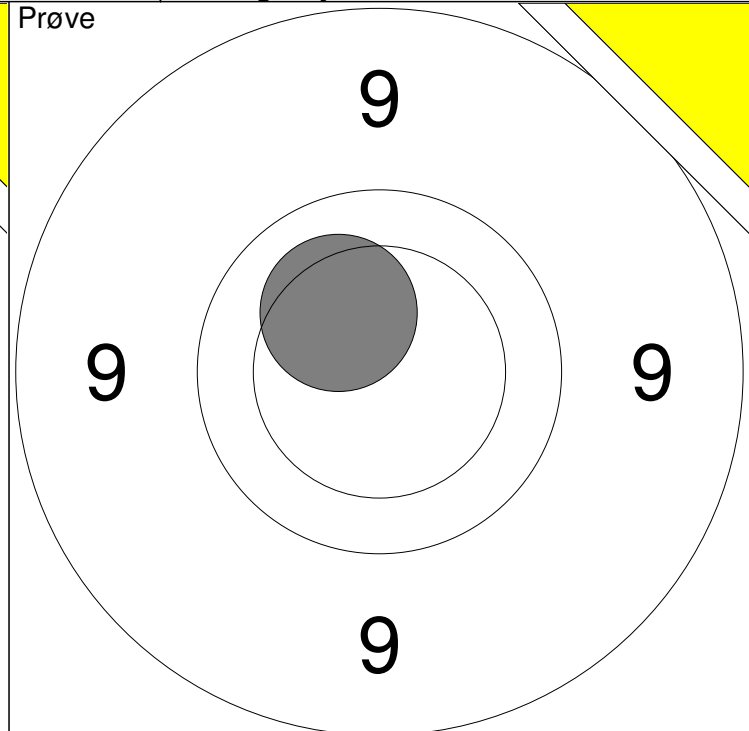
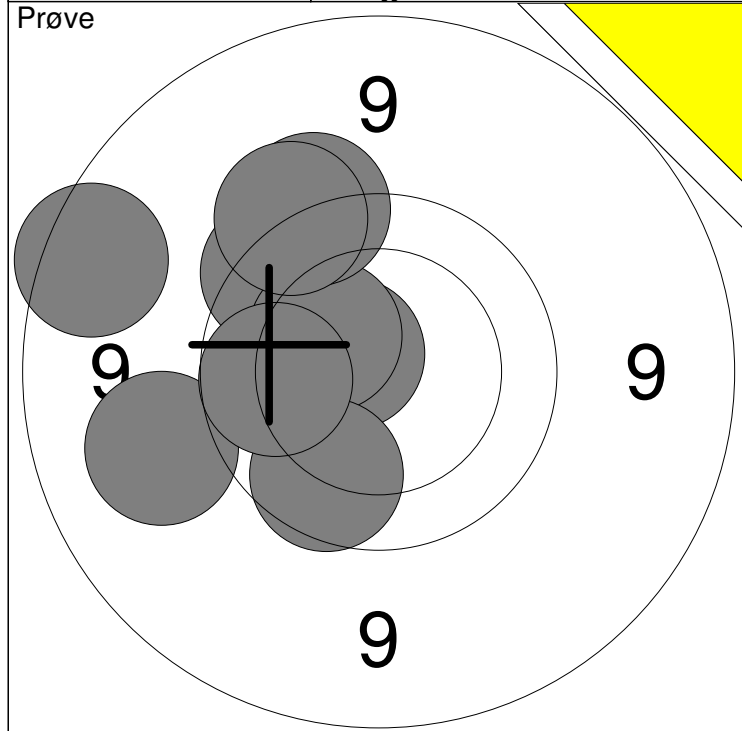

1: 10.6x ↗	6: 9.5 ↗	Serie	82
2: 9.7 ↗	7: 9.5 ↗		
3: 10.3 ↗	9: 9.9 ↘	Total	0
4: 9.2 ↖	10: 9.9 ↖		
5: 8.8 ↖			

12: 10.3 ↗	Serie	10
	Total	0

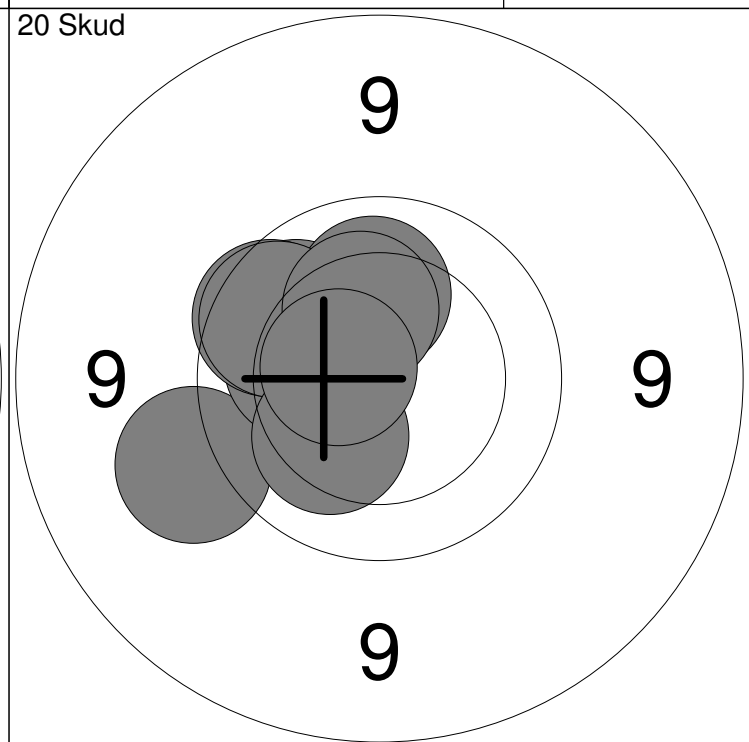
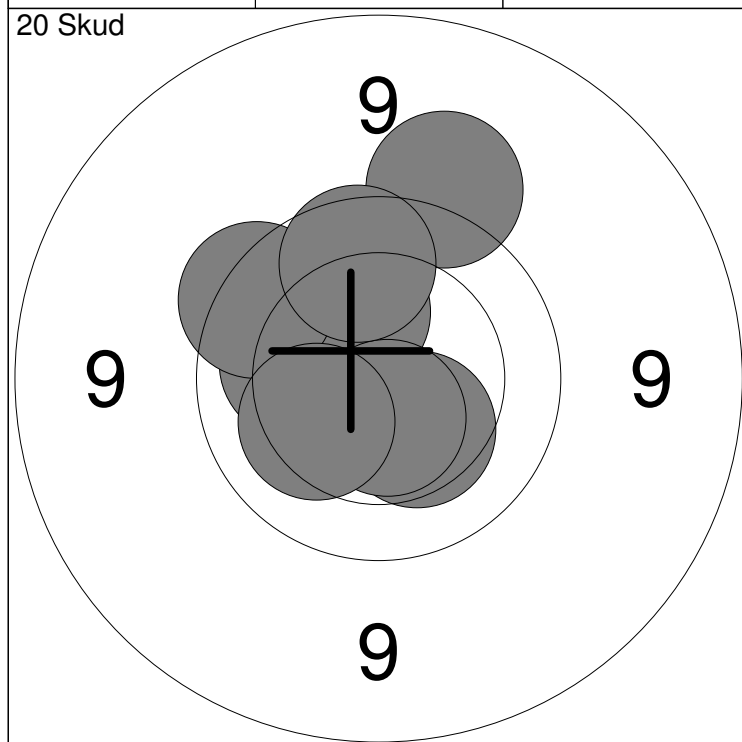

1: 10.2 ↖	6: 10.2 ↖	Serie	97
2: 10.3 ↘	7: 9.7 ↗		
3: 10.3 ↗	8: 10.6x ↘	Total	97
4: 9.4 ↗	9: 10.2 ↖		
5: 10.2 ↖	10: 9.9 ↗		

11: 10.0 ↗	16: 10.1 ↗	Serie	97
12: 10.4 ↖	17: 9.9 ↖		
13: 9.4 ↖	18: 10.3 ↗	Total	194
14: 10.2 ↖	19: 10.2 ↘		
15: 9.8 ↗	20: 10.5x ↖		

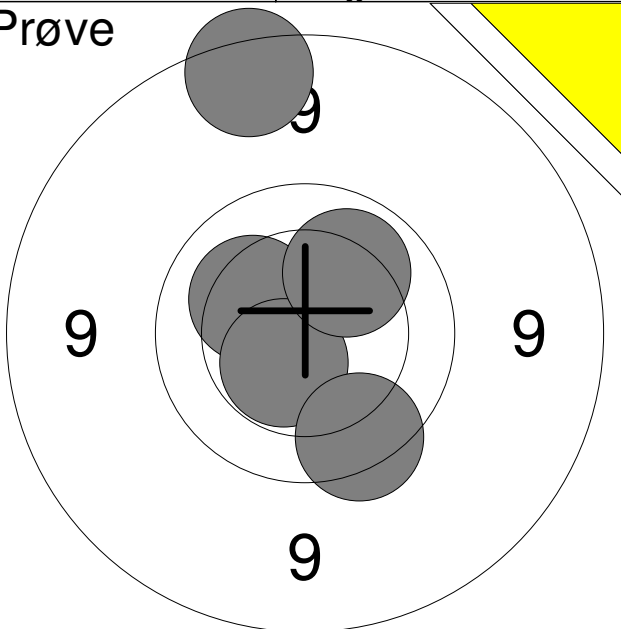
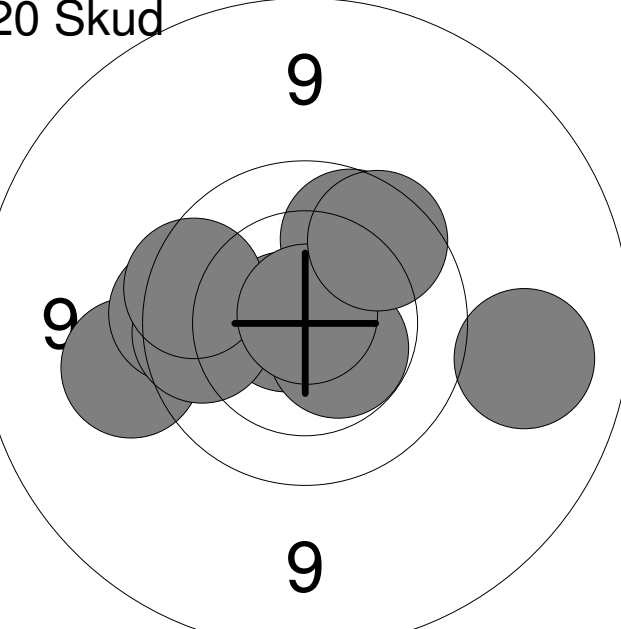
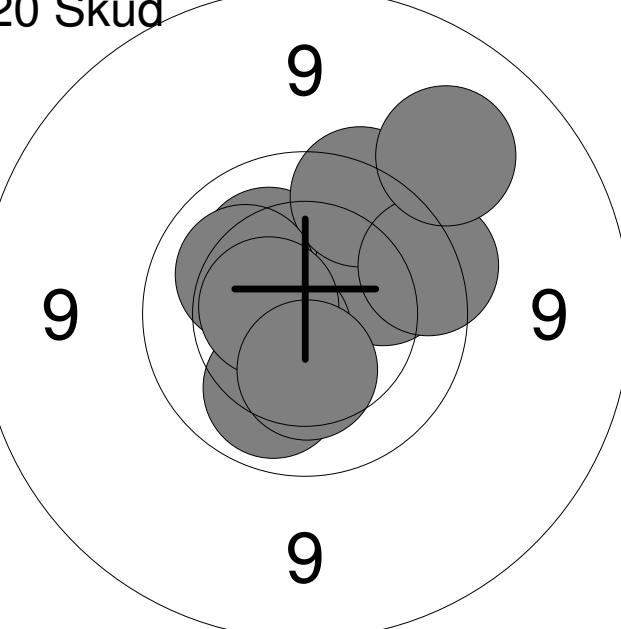
Hold	Skive	Malthe Nielsen		
9	8	Hjørring Skytteforening		J2
15m	Nordjysk mesterskab 2015		Aalborg Skyttekreds	
30.01.2015				
Prøve		1:	10.2	↗
		2:	8.8	↑
		3:	10.5x	↘
		4:	9.7	↘
		5:	10.1	↗
		<b>Serie</b>	<b>47.0</b>	
		<b>Total</b>	<b>0.0</b>	
20 Skud		1:	9.2	→
		2:	10.8x	←
		3:	9.4	←
		4:	10.5x	↘
		5:	9.7	←
		6:	9.9	←
		7:	9.9	↗
		8:	9.8	←
		9:	10.9x	↑
		10:	9.8	↗
		<b>Serie</b>	<b>93.0</b>	
		<b>Total</b>	<b>93.0</b>	
20 Skud		11:	10.2	↗
		12:	10.0	→
		13:	10.6x	←
		14:	9.7	↗
		15:	10.1	↘
		16:	9.7	→
		17:	9.2	↗
		18:	10.2	↗
		19:	10.6x	←
		20:	10.3	↓
		<b>Serie</b>	<b>97.0</b>	
		<b>Total</b>	<b>190.0</b>	

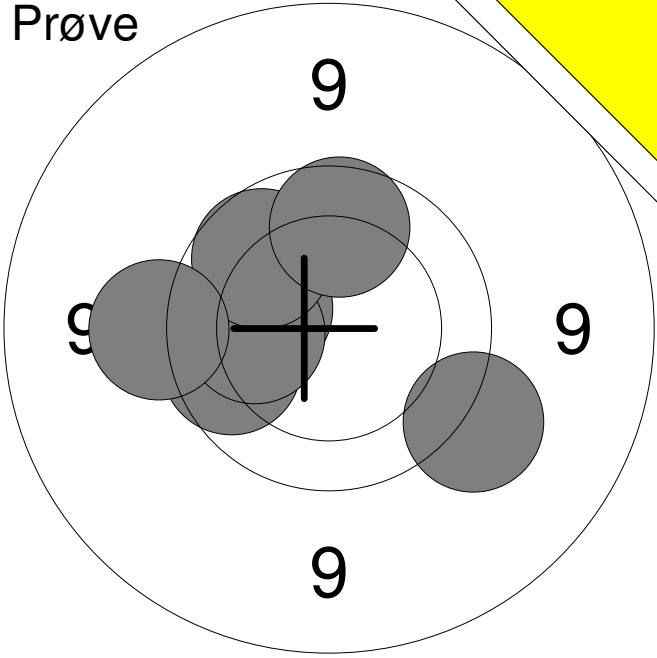
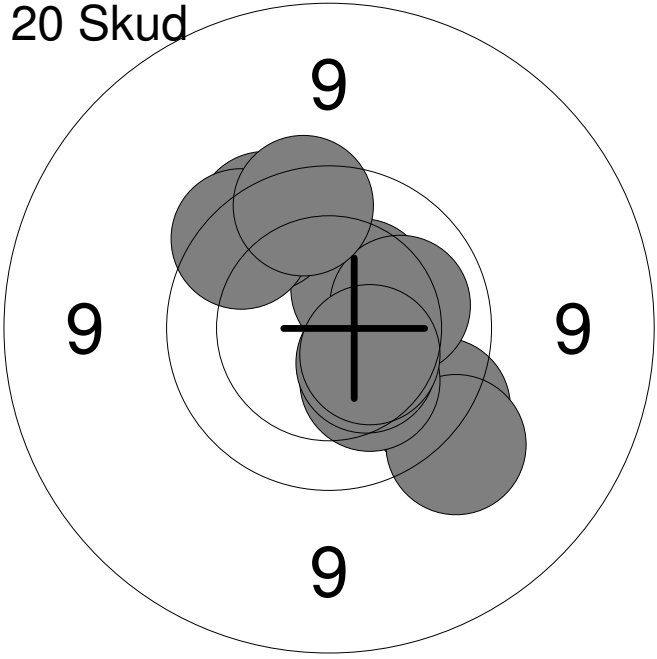
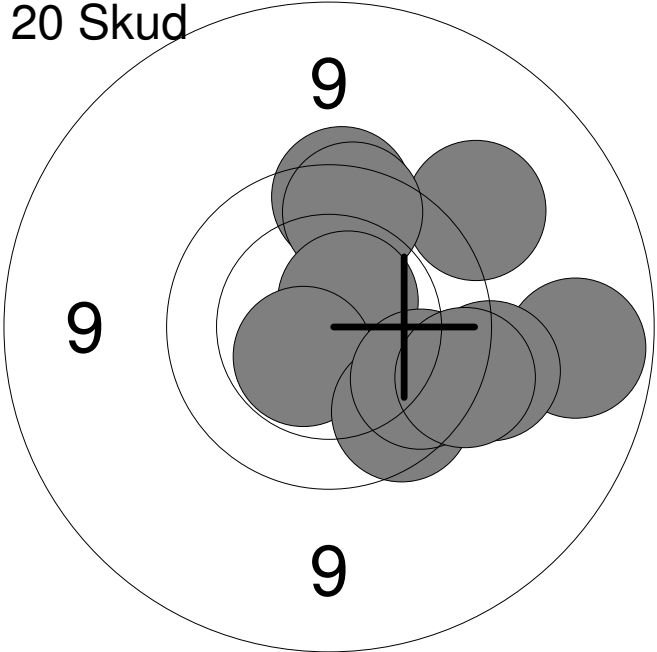
Hold	Skive	Lars Padfield	
9	9	15m	Hjørring Skytteforening J2
30.01.2015	Nordjysk mesterskab 2015	Aalborg Skyttekreds	
<b>Prøve</b> 	1:	10.2	←
	2:	9.9	←
	3:	10.1	←
	4:	9.9	↗
	5:	9.5	↘
	6:	9.9	↑
	7:	9.5	←
	<b>Serie</b>	<b>65.0</b>	
	<b>Total</b>	<b>0.0</b>	
<b>20 Skud</b> 	1:	9.7	↘
	2:	9.5	↘
	3:	10.4	↗
	4:	9.8	↗
	5:	10.2	↘
	6:	10.1	→
	7:	9.7	↗
	8:	10.4	↘
	9:	9.7	↑
	10:	10.4	↘
	<b>Serie</b>	<b>95.0</b>	
	<b>Total</b>	<b>95.0</b>	
<b>20 Skud</b> 	11:	9.4	↗
	12:	9.0	→
	13:	9.7	↑
	14:	9.5	→
	15:	9.8	↑
	16:	10.6x	↗
	17:	10.5x	↖
	18:	9.8	↘
	19:	9.9	↘
	20:	9.6	↘
	<b>Serie</b>	<b>92.0</b>	
	<b>Total</b>	<b>187.0</b>	

Hold <b>9</b>	Skive <b>10</b>	<b>Mathias Haugaard Mikkelsen</b>	
------------------	--------------------	-----------------------------------	--

15m	Hjørring Skytteforening	J1	
-----	-------------------------	----	--

30.01.2015	Nordjysk mesterskab 2015	Aalborg Skyttekreds	
------------	--------------------------	---------------------	--

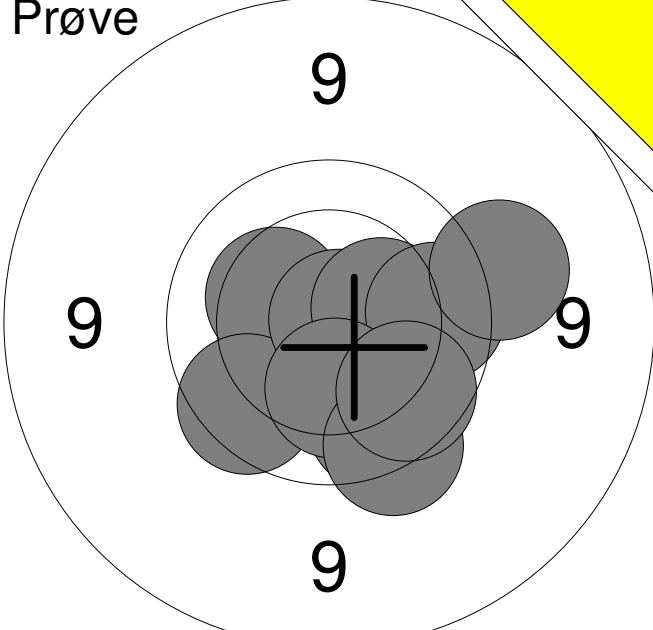
<b>Prøve</b> 	1:	10.3	↗
	2:	9.8	↘
	3:	10.8x	→
	4:	10.4	→
	5:	9.9	→
	6:	9.8	↘
	7:	10.2	↘
	8:	9.7	↘
	9:	9.4	→
	10:	9.9	↘
	<b>Serie</b>		<b>94.0</b>
<b>Total</b>		<b>0.0</b>	

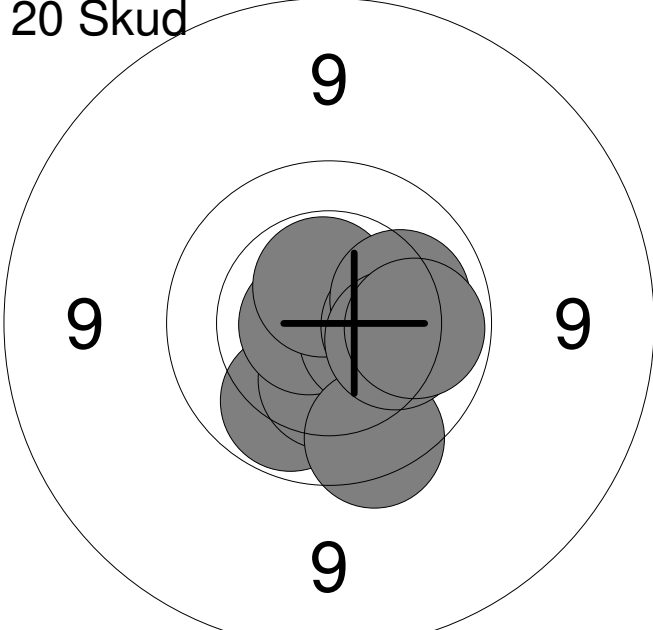
<b>20 Skud</b> 	1:	10.0	↘
	2:	10.3	↘
	3:	10.7x	←
	4:	10.5	→
	5:	10.6x	↑
	6:	10.3	→
	7:	9.8	↘
	8:	10.1	→
	9:	10.2	→
	10:	10.0	→
	<b>Serie</b>		<b>99.0</b>
<b>Total</b>		<b>99.0</b>	

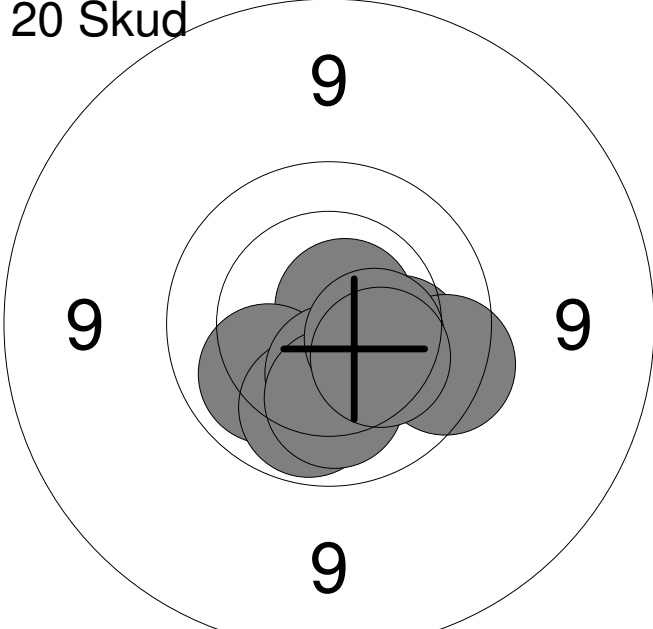
<b>20 Skud</b> 	11:	10.4	↘
	12:	10.2	→
	13:	10.7x	↗
	14:	9.8	→
	15:	10.1	↘
	16:	10.0	↘
	17:	10.4	↘
	18:	10.1	↘
	19:	10.4	→
	20:	10.3	↘
	<b>Serie</b>		<b>99.0</b>
<b>Total</b>		<b>198.0</b>	

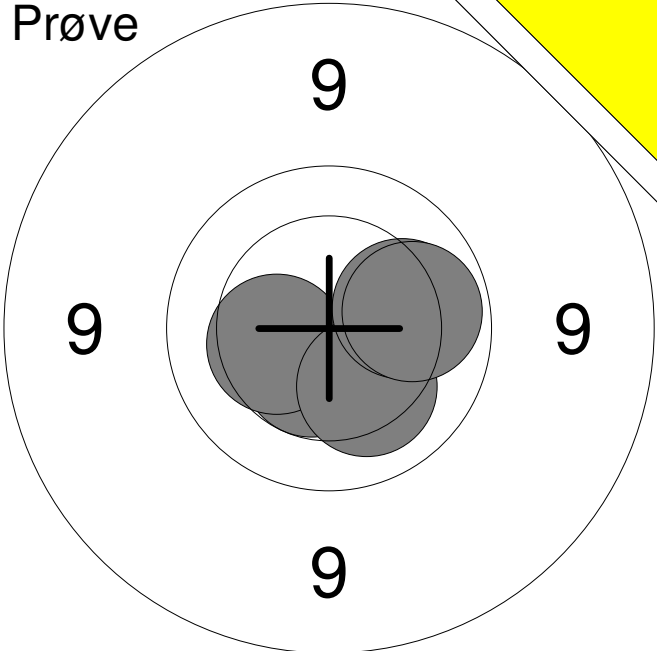
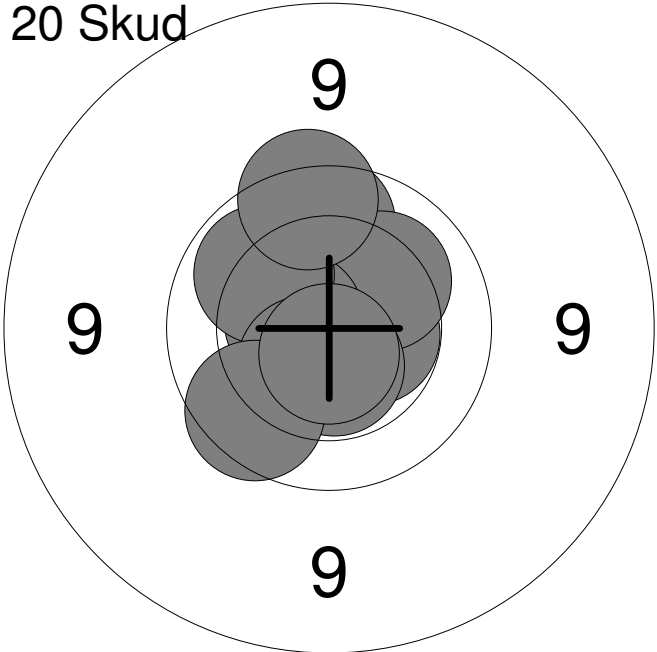
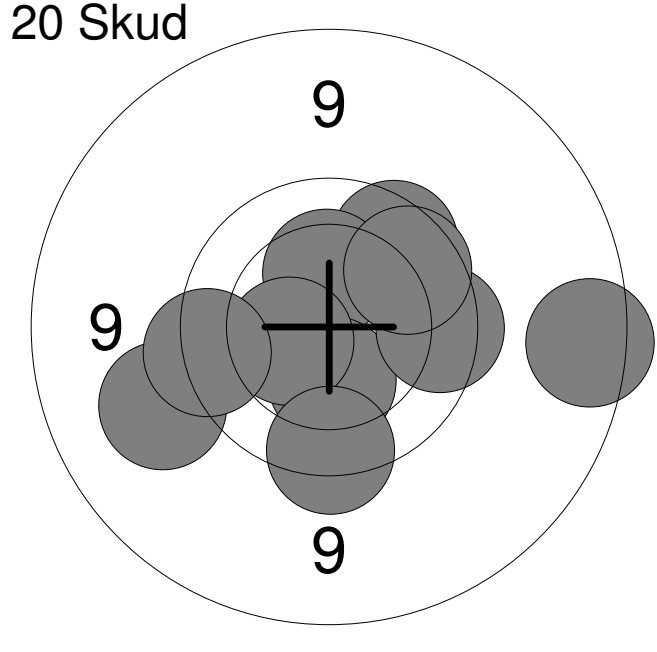
Hold	Skive	Jonas Christian Larsen		
9	11	Hjørring Skytteforening		J2
15m	Nordjysk mesterskab 2015		Aalborg Skyttekreds	
30.01.2015				
Prøve		1:	10.5x	↘
		2:	10.4	←
		3:	10.2	↘
		4:	10.1	→
		5:	10.0	→
		Serie	50.0	
		Total	0.0	
20 Skud		1:	9.9	↑
		2:	10.5x	→
		3:	10.2	↗
		4:	10.6x	←
		5:	10.0	↗
		6:	10.5	↘
		7:	10.5x	↘
		8:	9.8	↖
		9:	9.7	↑
		10:	10.7x	↓
		Serie	97.0	
		Total	97.0	
20 Skud		11:	9.8	↗
		12:	8.8	→
		13:	10.3	↑
		14:	10.3	↓
		15:	9.8	→
		16:	10.5	←
		17:	9.3	↖
		18:	9.7	←
		19:	9.9	↗
		20:	9.7	↓
		Serie	92.0	
		Total	189.0	

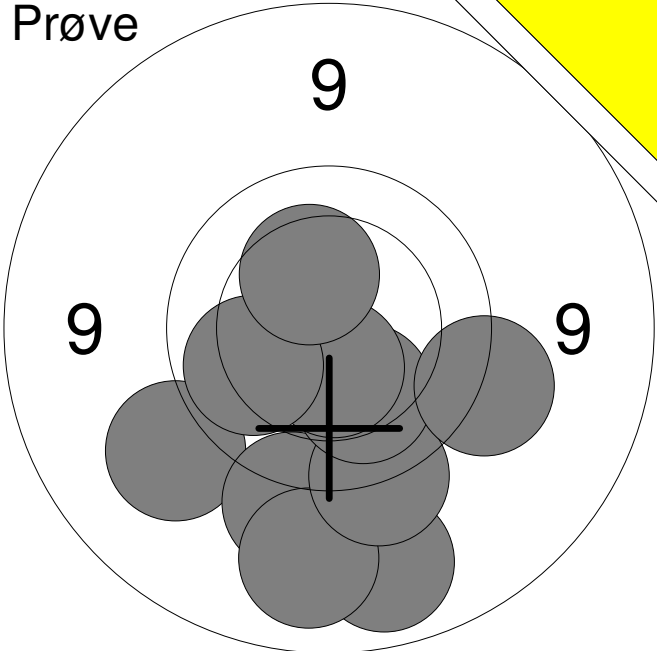
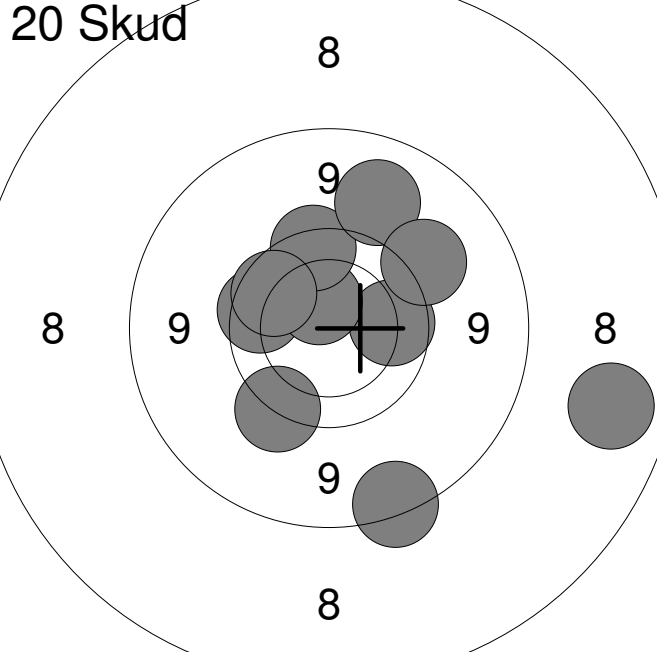
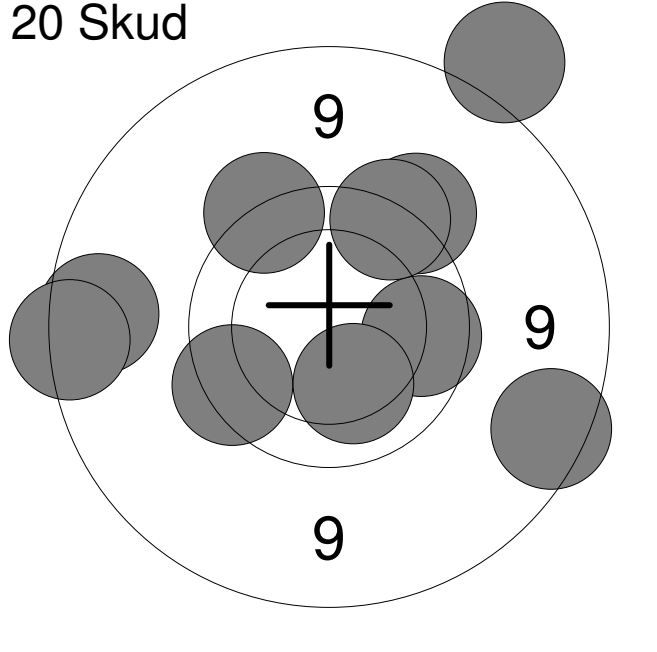
Hold <b>9</b>	Skive <b>12</b>	<b>Jolan Lade</b>	
15m	Hjørring Skytteforening		J2
30.01.2015	Nordjysk mesterskab 2015		Aalborg Skyttekreds
Prøve 	1:	9.0	↓
	2:	9.3	↙
	3:	9.4	↓
	4:	9.1	↓
	5:	9.6	↓
	6:	10.2	↓
	7:	10.5x	↓
	8:	10.0	↙
	9:	9.5	→
	10:	10.3	↑
	<b>Serie</b>		<b>94.0</b>
	<b>Total</b>		<b>0.0</b>
20 Skud 	1:	8.7	↓
	2:	9.9	→
	3:	9.8	↙
	4:	10.5	↑
	5:	9.6	↓
	6:	9.7	↑
	7:	9.2	↑
	8:	8.1	→
	9:	9.9	↗
	10:	9.4	↗
	<b>Serie</b>		<b>89.0</b>
	<b>Total</b>		<b>89.0</b>
20 Skud 	11:	8.9	↙
	12:	9.9	→
	13:	9.5	↗
	14:	9.7	↙
	15:	8.8	↙
	16:	8.8	→
	17:	8.5	↗
	18:	10.2	↓
	19:	9.6	↗
	20:	9.6	↗
	<b>Serie</b>		<b>87.0</b>
	<b>Total</b>		<b>176.0</b>

Hold	Skive	Rasmus Greth Sørensen	
10	1	15m	Skf. Kimbrene BK1
30.01.2015	Nordjysk mesterskab 2015	Aalborg Skyttekreds	
Prøve		1: 8.8 →	
		2: 10.2 ↗	
		3: 10.5 ↘	
		4: 9.9 ↘	
		5: 10.3 ↓	
		6: 10.6x ↘	
		7: 10.7x ↗	
		<b>Serie</b>	<b>67.0</b>
		<b>Total</b>	<b>0.0</b>
20 Skud		1: 10.3 ←	
		2: 10.6x ↓	
		3: 10.6x ↓	
		4: 9.8 ←	
		5: 10.2 ←	
		6: 10.6x ↓	
		7: 10.4 ↓	
		8: 10.5 ↓	
		9: 10.8x ←	
		10: 10.3 ↘	
		<b>Serie</b>	<b>99.0</b>
		<b>Total</b>	<b>99.0</b>
20 Skud		11: 10.4 →	
		12: 10.3 →	
		13: 10.1 ↗	
		14: 10.5 ↑	
		15: 10.0 ↓	
		16: 10.8x ↑	
		17: 10.6x ↗	
		18: 10.8x ↓	
		19: 10.0 ↗	
		20: 10.1 ←	
		<b>Serie</b>	<b>100.0</b>
		<b>Total</b>	<b>199.0</b>

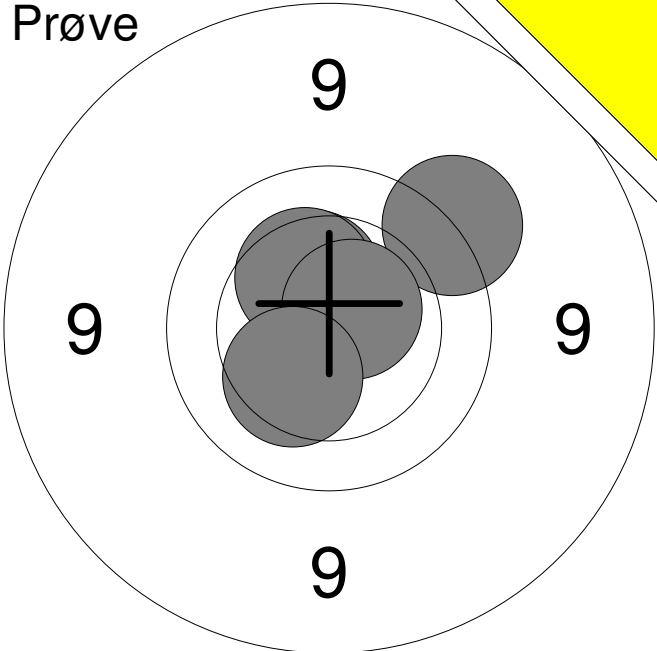
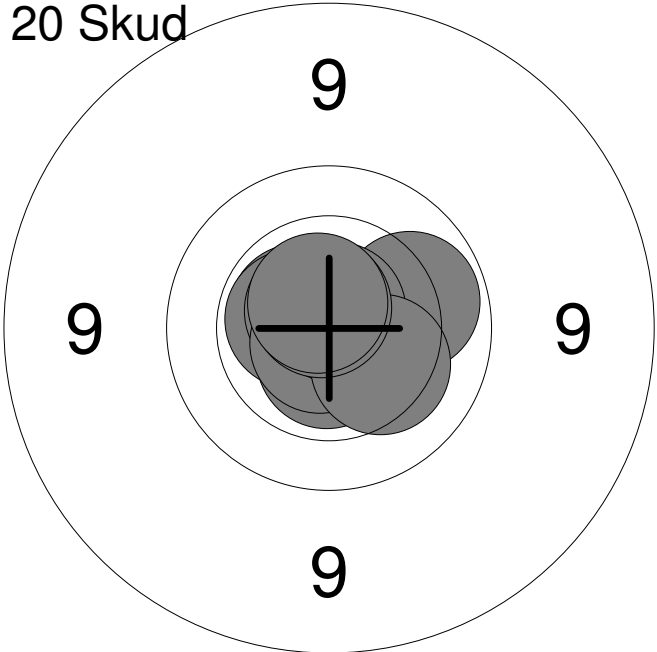
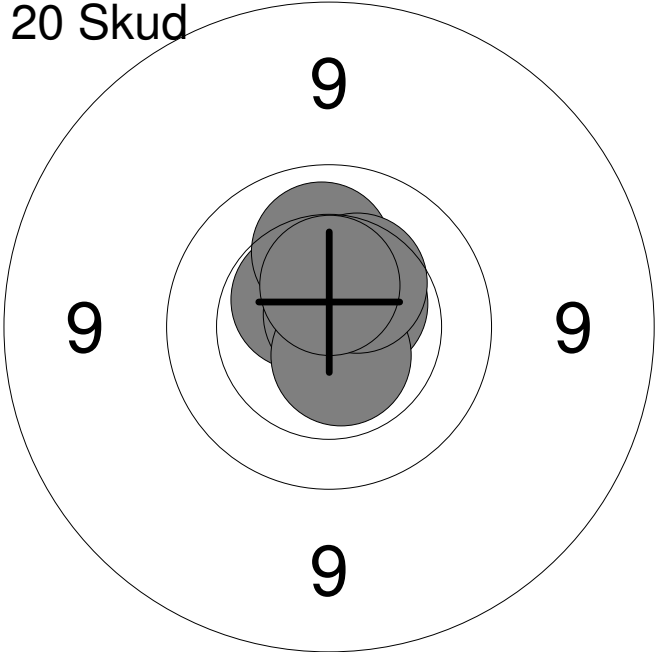
Hold	Skive	Jacob Evans Jensen		
10	2	Skf. Kimbrene	MB1	
15m				
30.01.2015		Nordjysk mesterskab 2015	Aalborg Skyttekreds	
Prøve		1:	9.5	↗
		2:	10.4	↖
		3:	10.3	↖
		4:	10.6x	↗
		5:	10.3	↘
		Serie		49.0
		Total		0.0
20 Skud		1:	10.0	→
		2:	10.6x	↖
		3:	10.6x	↓
		4:	10.6x	↖
		5:	10.7x	↗
		6:	10.8x	↘
		7:	10.8x	↗
		8:	10.3	↘
		9:	10.7x	↗
		10:	10.7x	↗
		Serie		100.0
		Total		100.0
20 Skud		11:	10.5x	↑
		12:	10.6x	↗
		13:	10.5x	↖
		14:	10.5x	↖
		15:	10.5	↗
		16:	10.8x	↗
		17:	10.6x	↓
		18:	10.1	↑
		19:	10.4	↗
		20:	10.5x	↑
		Serie		100.0
		Total		200.0



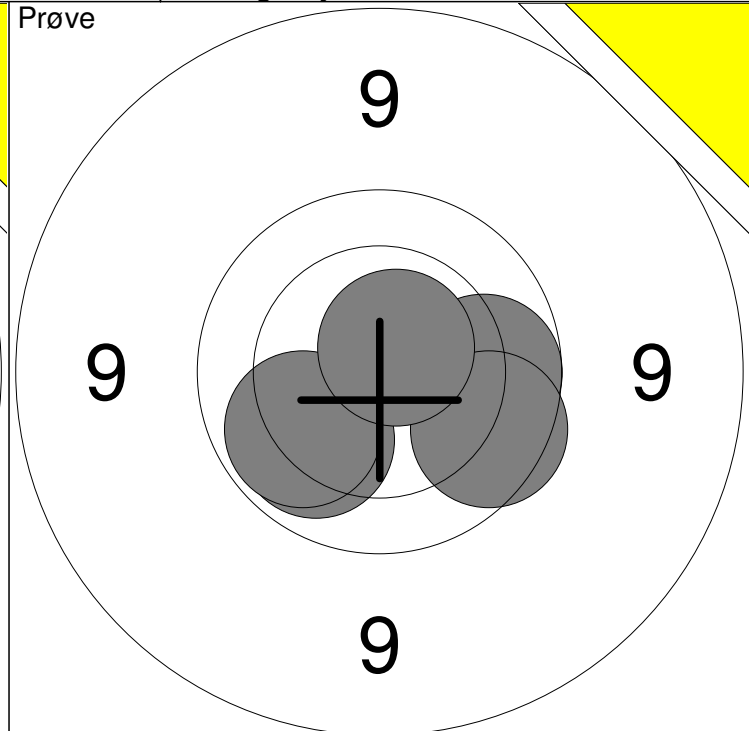
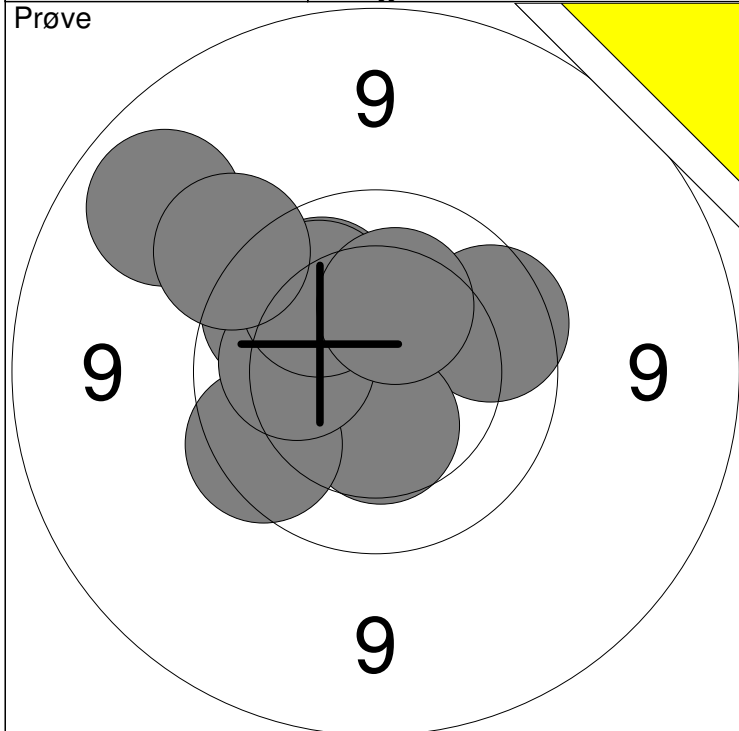

1: 9.8 →	6: 9.8 ←	Serie	95
2: 9.1 ↗	7: 10.2 ←		
3: 10.4 ↓	8: 10.1 ↗	Total	0
4: 9.9 ↗	9: 9.5 ↗		
5: 10.1 ↗	10: 10.3 ↗		

11: 10.0 ↙	Serie	48
12: 10.0 ↙		
13: 9.9 →	Total	0
14: 9.8 ↘		
15: 10.7x ↗		

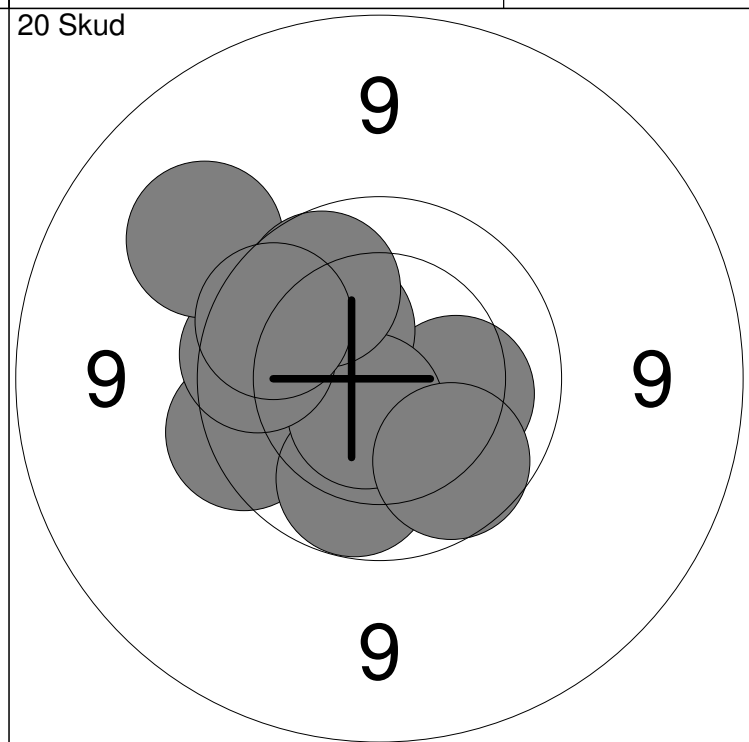
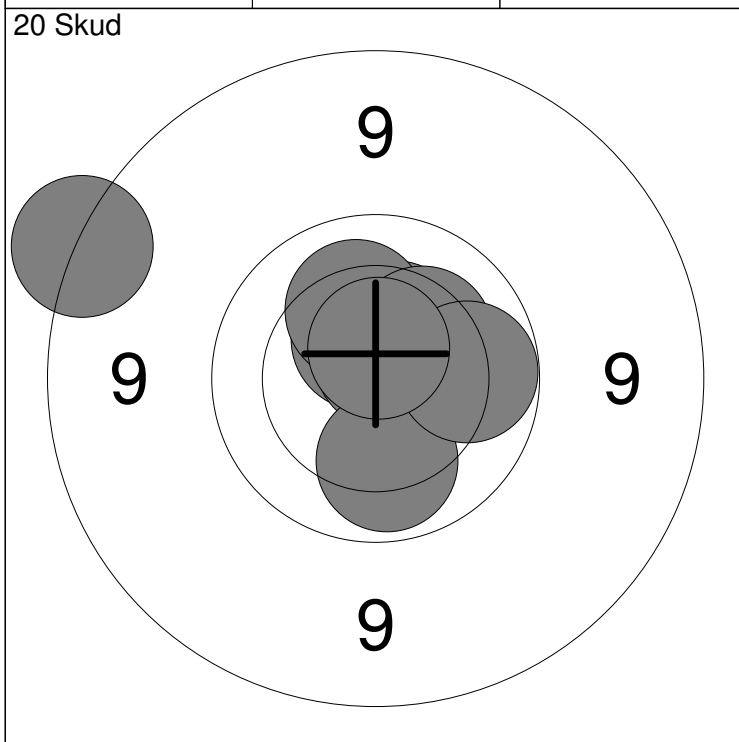

1: 10.5x ↗	6: 10.1 ↓	Serie	98
2: 10.4 ↗	7: 10.3 ↗		
3: 10.7x ↗	8: 10.0 →	Total	98
4: 10.5x ↗	9: 8.7 ←		
5: 10.2 ↗	10: 10.6x ↗		

11: 10.2 →	16: 9.8 ←	Serie	94
12: 9.7 ←	17: 9.3 ↗		
13: 10.3 ↗	18: 9.9 ↗	Total	192
14: 10.0 ↓	19: 9.9 ↗		
15: 10.6x ↙	20: 9.9 ↘		

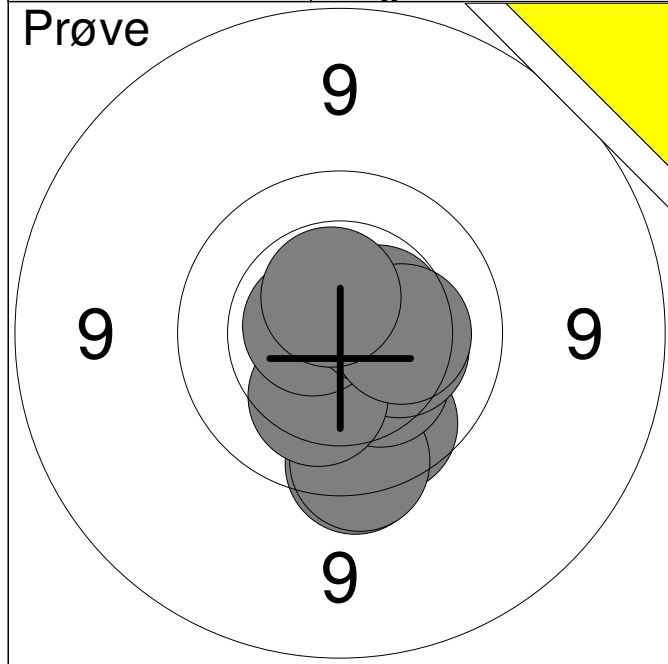

1:	9.9	↘
2:	9.7	↘
3:	9.7	↘
4:	10.3	↘
5:	10.3	→
6:	10.2	↘
7:	10.6x	↖
8:	10.5x	→
9:	10.3	→
10:	10.5x	↖
<b>Serie</b>	<b>97.0</b>	
<b>Total</b>	<b>0.0</b>	

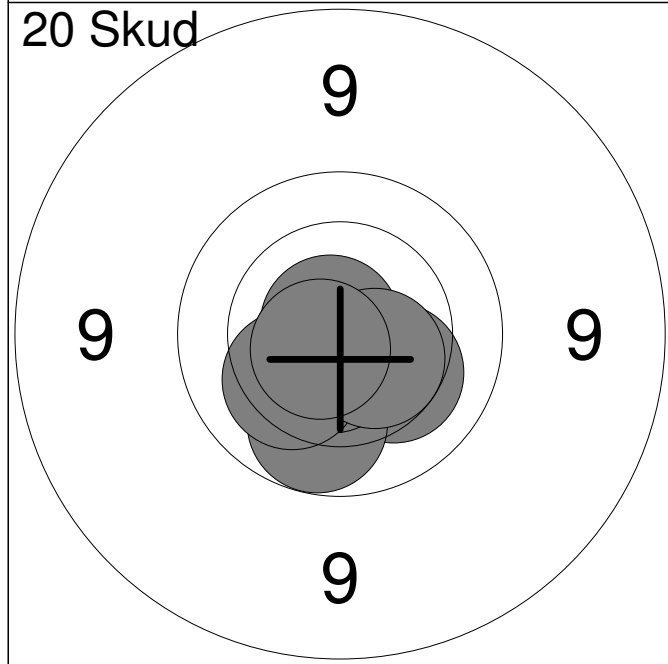

1:	10.8x	↘
2:	10.2	↘
3:	10.0	↘
4:	10.7x	↘
5:	10.7x	↖
6:	10.6x	↘
7:	10.2	↖
8:	10.8x	↗
9:	10.5	↘
10:	10.7x	↖
<b>Serie</b>	<b>100.0</b>	
<b>Total</b>	<b>100.0</b>	

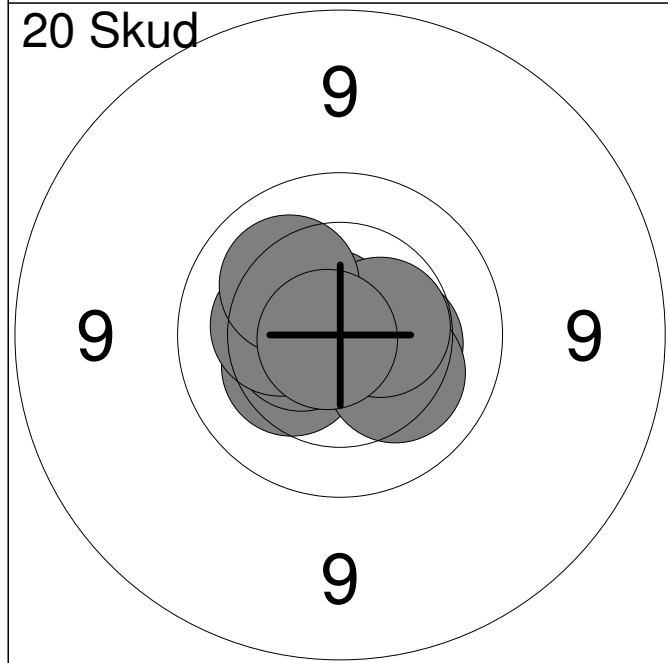

11:	10.3	↖
12:	10.8x	↖
13:	10.7x	↗
14:	10.5x	↖
15:	10.4	→
16:	10.2	↘
17:	10.5x	→
18:	10.3	↖
19:	10.2	↗
20:	10.8x	↖
<b>Serie</b>	<b>100.0</b>	
<b>Total</b>	<b>200.0</b>	

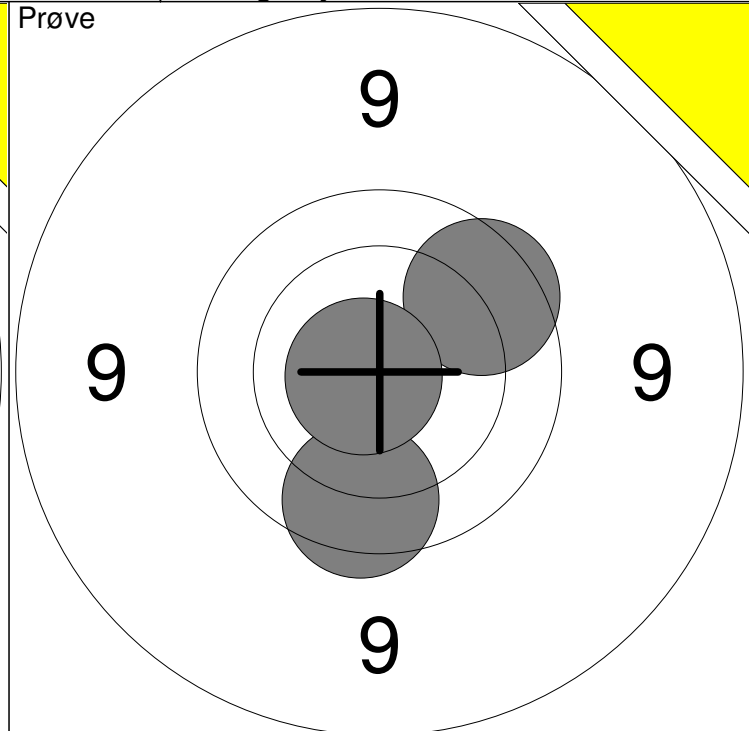
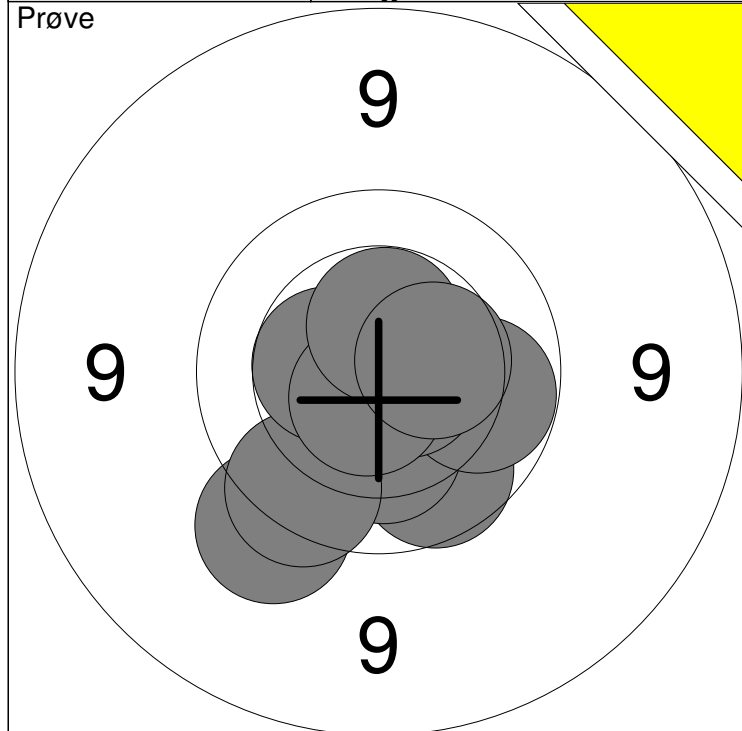

1: 9.5 ↙	6: 10.5 ←	Serie	97
2: 9.9 ↓	7: 10.7x →		
3: 10.2 ↓	8: 10.7x ↓	Total	0
4: 10.0 →	9: 10.5x ↑		
5: 9.8 ↙	10: 10.4 →		

11: 9.8 ↗	Serie	28
12: 9.8 ↓		
13: 10.8x ←	Total	0

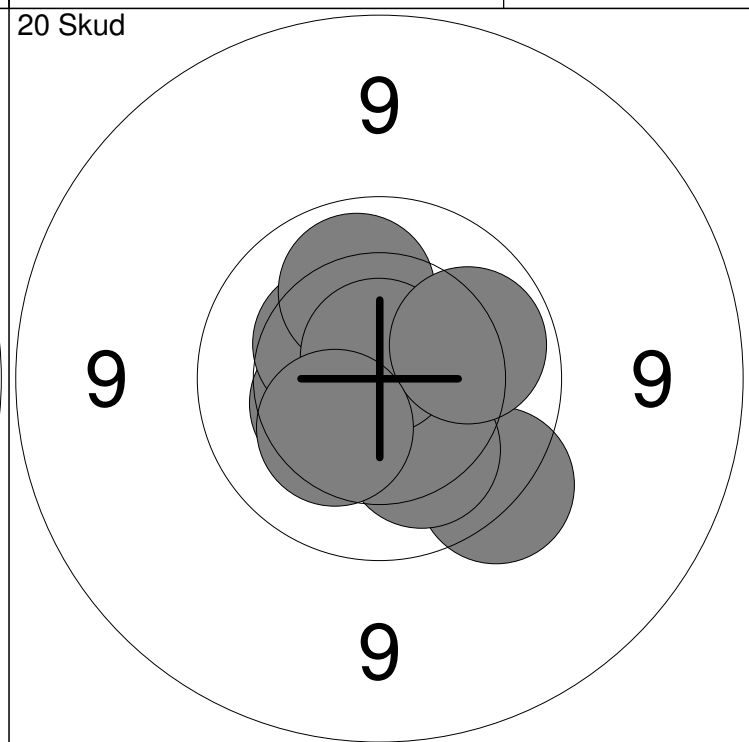
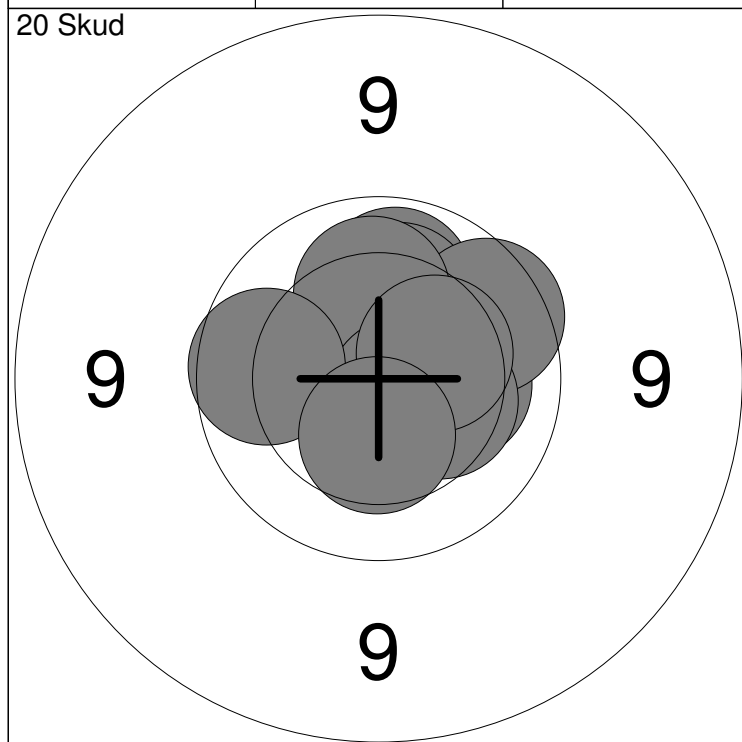

1: 10.0 ↑	6: 10.6x ↓	Serie	98
2: 10.2 ↑	7: 9.9 ←		
3: 10.2 →	8: 10.3 →	Total	98
4: 9.8 ↗	9: 10.4 ↗		
5: 10.1 ↑	10: 10.4 ↓		

11: 10.7x ↓	16: 10.2 ↓	Serie	99
12: 10.4 ←	17: 10.1 ↑		
13: 10.9x ↓	18: 10.7x ↑	Total	197
14: 9.7 ↓	19: 10.0 ↗		
15: 10.4 ↗	20: 10.3 ↙		

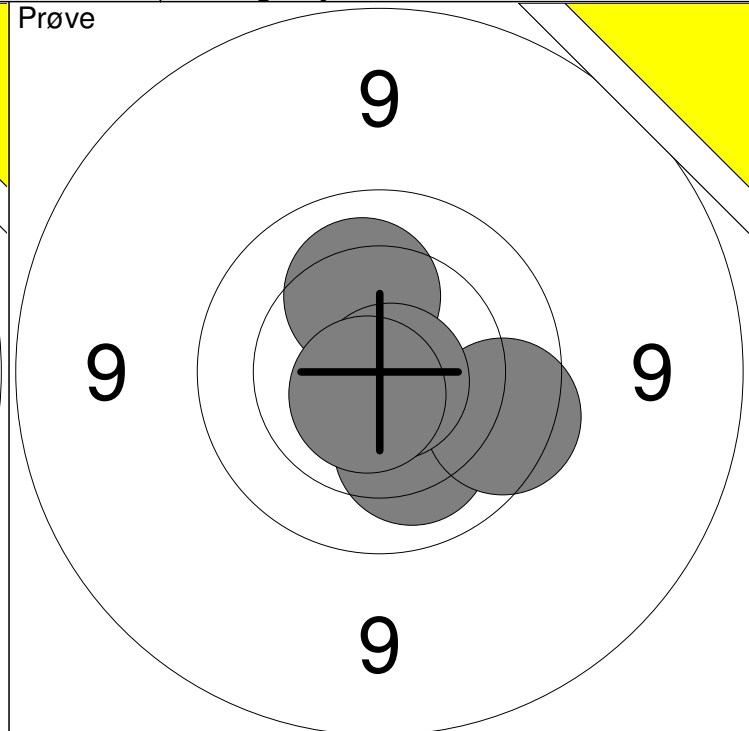
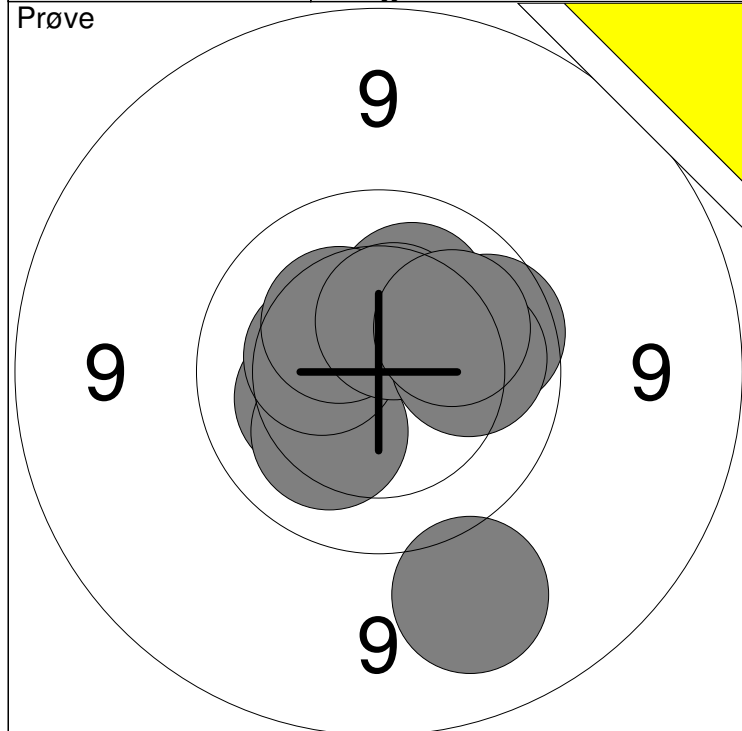

1: 9.2 ↓	6: 10.4 ↖	Serie	98
2: 10.2 ↑	7: 10.4 ↑		
3: 10.3 ←	8: 9.9 →	Total	0
4: 10.2 ↘	9: 10.1 →		
5: 10.4 ←	10: 10.1 ↗		

11: 10.2 ↑	Serie	49
12: 10.2 ↓		
13: 9.8 →	Total	0
14: 10.8x ↘		
15: 10.7x ↙		

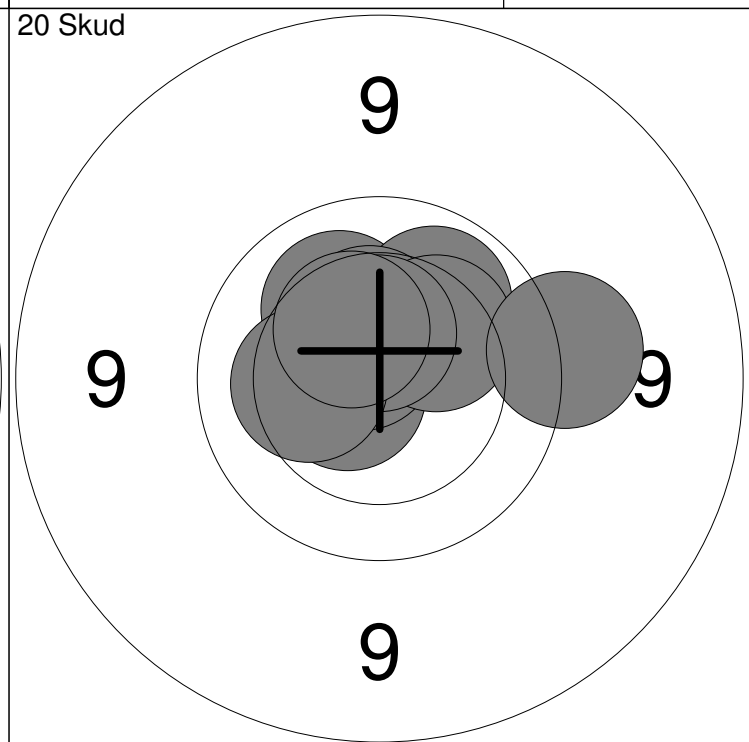
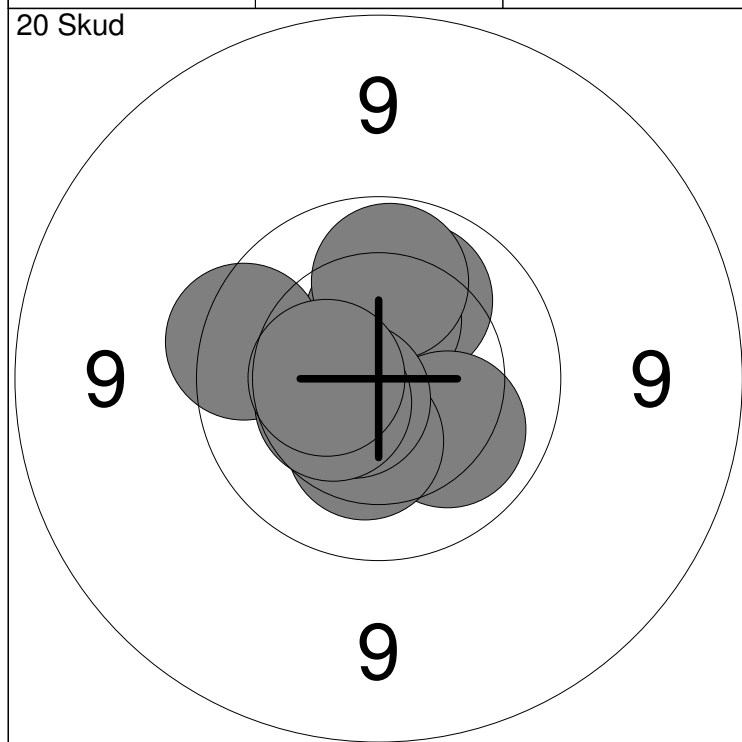

1: 10.1 ↑	6: 10.3 ↓	Serie	99
2: 10.4 ↑	7: 10.0 ↑		
3: 9.8 ←	8: 10.6x ↘	Total	99
4: 10.5 ↓	9: 10.5 ←		
5: 10.1 ↘	10: 10.4 ←		

11: 10.6x ←	16: 10.2 ↗	Serie	99
12: 10.6x ↖	17: 9.5 →		
13: 10.2 ↖	18: 10.5x ↑	Total	198
14: 10.1 ↗	19: 10.3 ←		
15: 10.4 ↑	20: 10.4 ↖		

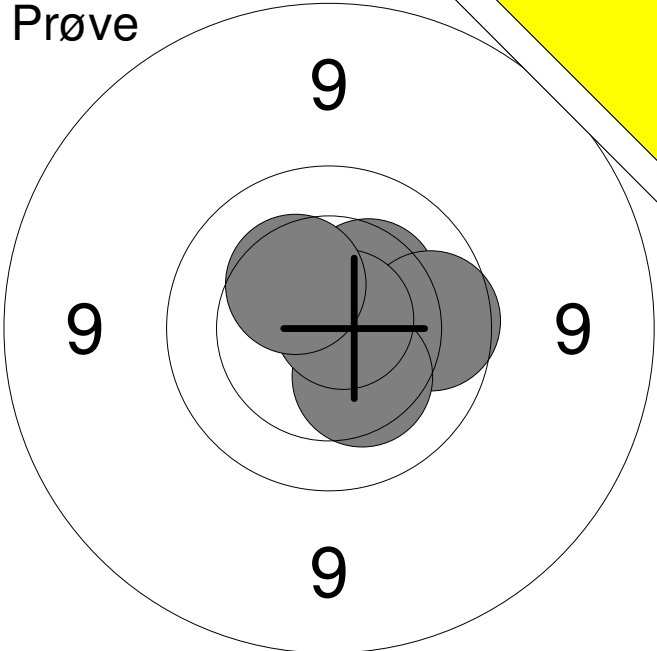
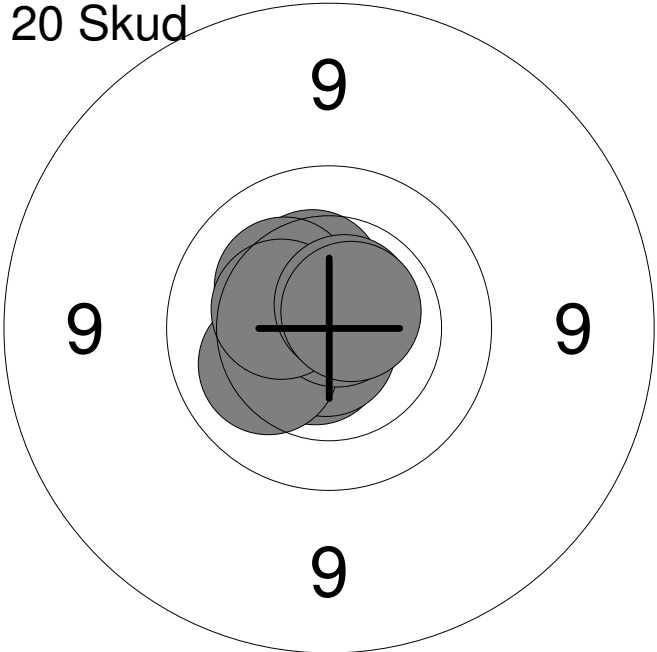
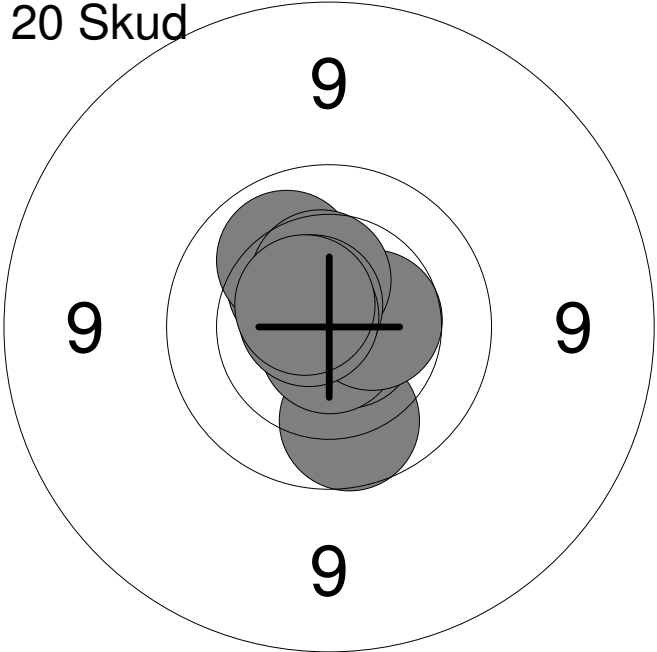
Hold	Skive	Pernille Holst Andersen		
10	7	15m	Skf. Kimbreerne	MJ1
30.01.2015	Nordjysk mesterskab 2015	Aalborg Skyttekreds		
Prøve		1:	10.3	↗
		2:	9.9	→
		3:	10.3	↘
		4:	10.8x	↗
		5:	10.4	↗
		<b>Serie</b>	<b>49.0</b>	
		<b>Total</b>	<b>0.0</b>	
20 Skud		1:	10.6x	↙
		2:	10.4	↗
		3:	10.7x	↙
		4:	10.7x	↘
		5:	10.2	↙
		6:	10.3	↗
		7:	10.8x	↗
		8:	10.4	↖
		9:	10.7x	↗
		10:	10.7x	↗
		<b>Serie</b>	<b>100.0</b>	
		<b>Total</b>	<b>100.0</b>	
20 Skud		11:	9.9	↘
		12:	10.4	↗
		13:	10.1	↗
		14:	10.7x	↘
		15:	10.8x	↘
		16:	10.5	→
		17:	10.4	↗
		18:	10.7x	↗
		19:	10.7x	↗
		20:	10.6x	↗
		<b>Serie</b>	<b>99.0</b>	
		<b>Total</b>	<b>199.0</b>	

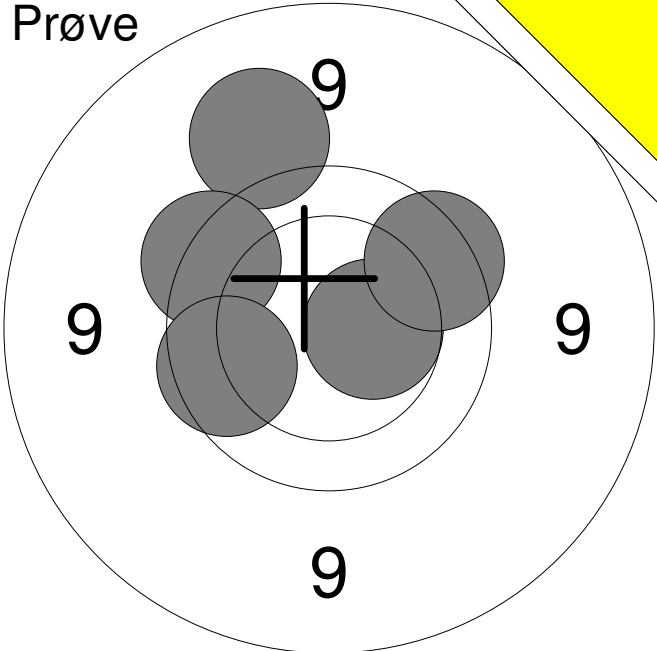
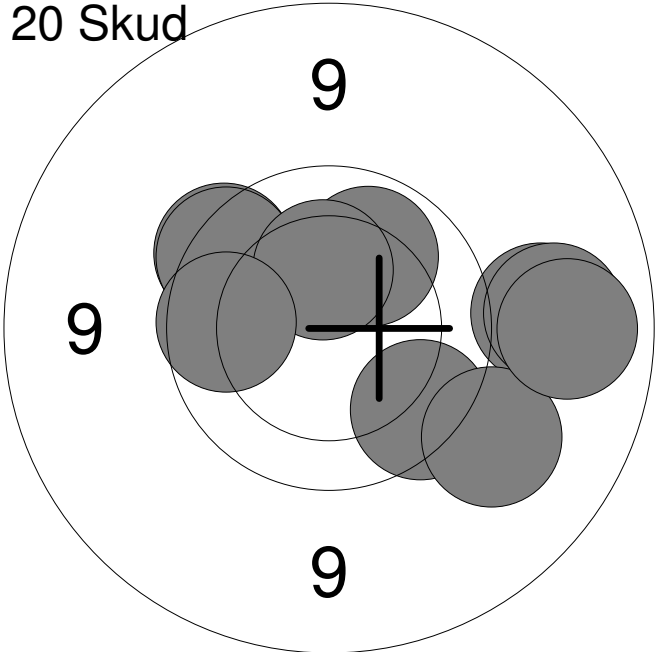
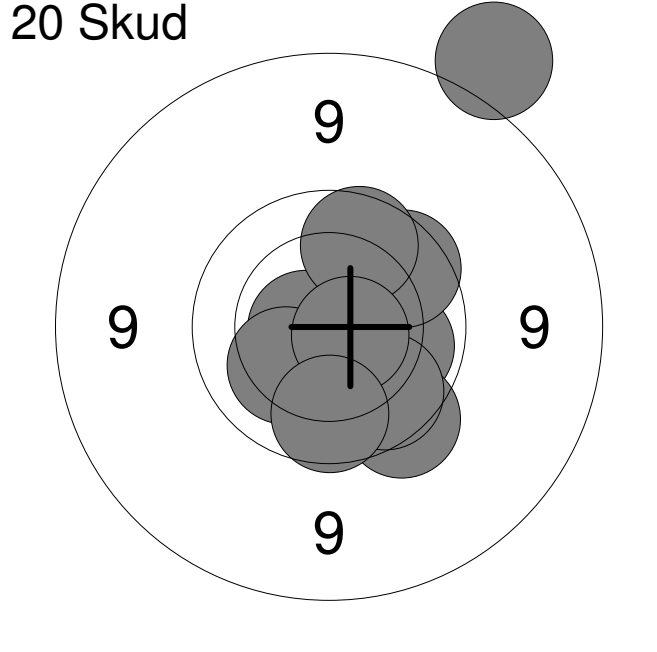
Hold	Skive	Lucas Friberg		
10	9	Hjørring Skytteforening		MB3
15m	Nordjysk mesterskab 2015		Aalborg Skyttekreds	
30.01.2015				
Prøve		1:	9.3	↑
		2:	9.7	↖
		3:	9.9	←
		4:	10.5	→
		5:	9.7	↗
		Serie		46.0
		Total		0.0
20 Skud		1:	9.7	↖
		2:	9.8	↖
		3:	9.2	→
		4:	9.8	↘
		5:	10.1	↗
		6:	9.1	→
		7:	9.3	↘
		8:	9.1	→
		9:	10.3	↑
		10:	9.9	←
		Serie		92.0
		Total		92.0
20 Skud		11:	10.1	→
		12:	10.7x	←
		13:	9.7	↘
		14:	9.8	↗
		15:	9.9	↗
		16:	9.9	↘
		17:	10.2	←
		18:	10.7x	→
		19:	9.9	↘
		20:	8.5	↗
		Serie		93.0
		Total		185.0

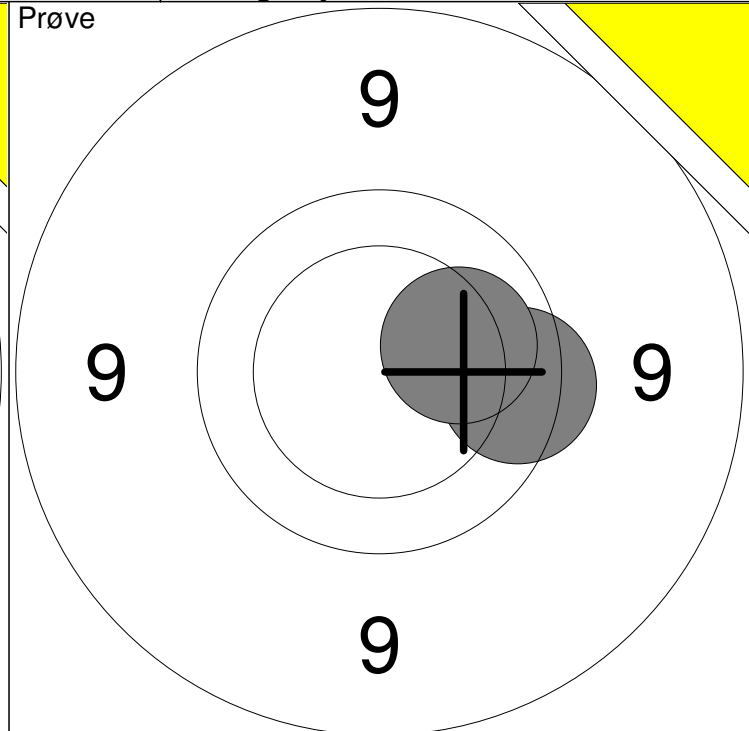
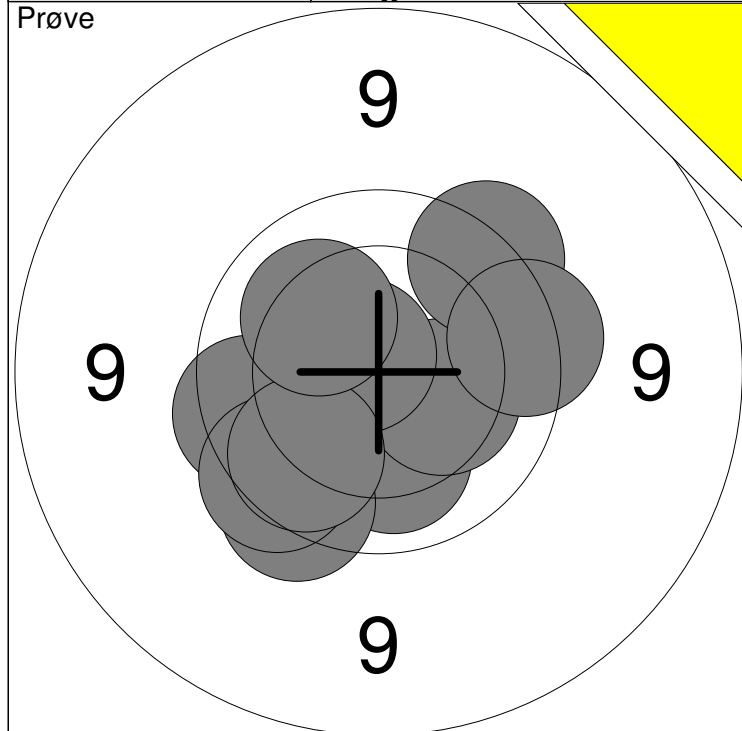

1: 10.1 ↓	6: 9.7 ↙	Serie	94
2: 10.3 →	7: 9.8 ←		
3: 9.7 ↗	8: 9.7 ↙	Total	0
4: 9.7 →	9: 9.9 ↙		
5: 10.7x ↖	10: 10.2 ↖		

11: 9.8 →	Serie	19
12: 10.1 →		
Total		0

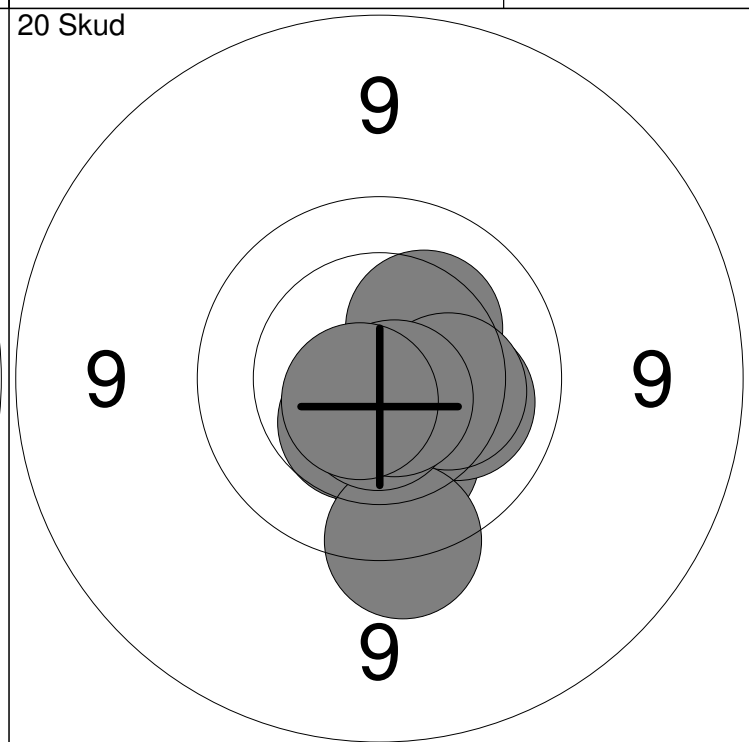
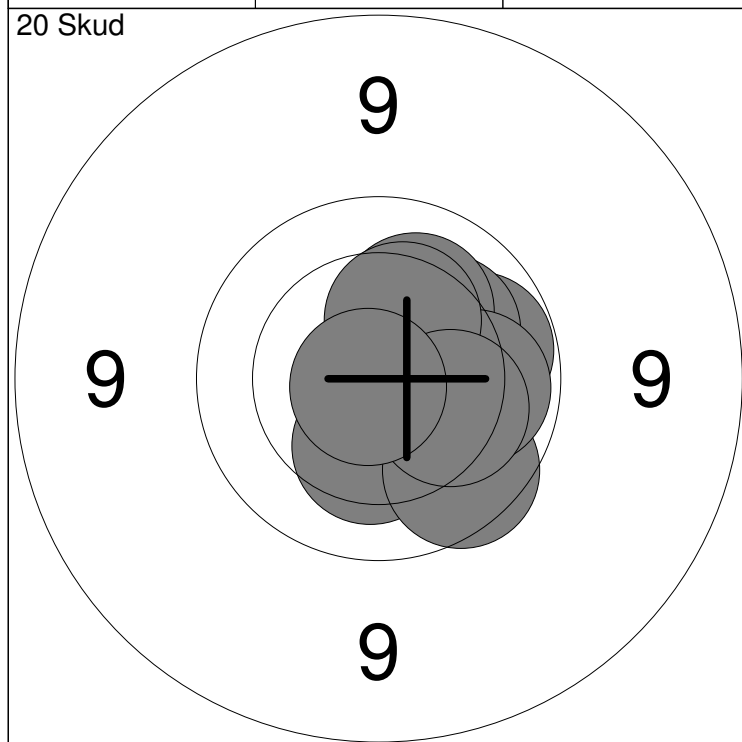

1: 10.0 →	6: 9.8 ↙	Serie	99
2: 10.2 ↗	7: 10.0 →		
3: 10.6x ↓	8: 10.3 ↗	Total	99
4: 10.2 ↗	9: 10.2 →		
5: 10.3 ↓	10: 10.8x ↖		

11: 10.2 ↓	16: 10.3 →	Serie	99
12: 10.3 ↗	17: 9.6 ↓		
13: 10.2 →	18: 10.6x ↓	Total	198
14: 10.5 ↙	19: 10.7x ↓		
15: 10.7x ↓	20: 10.7x ↙		

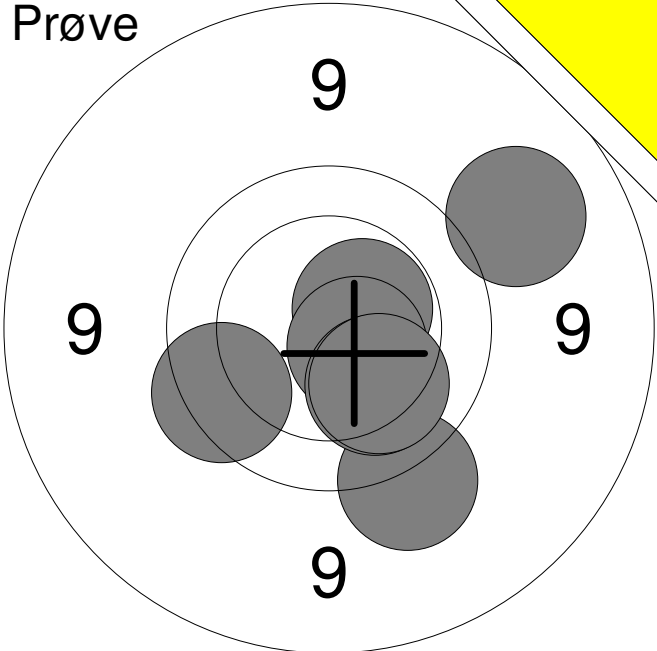
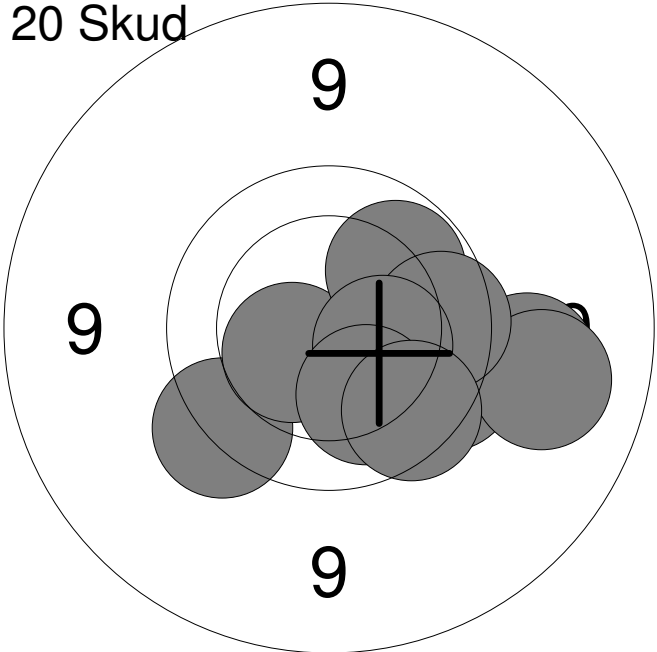
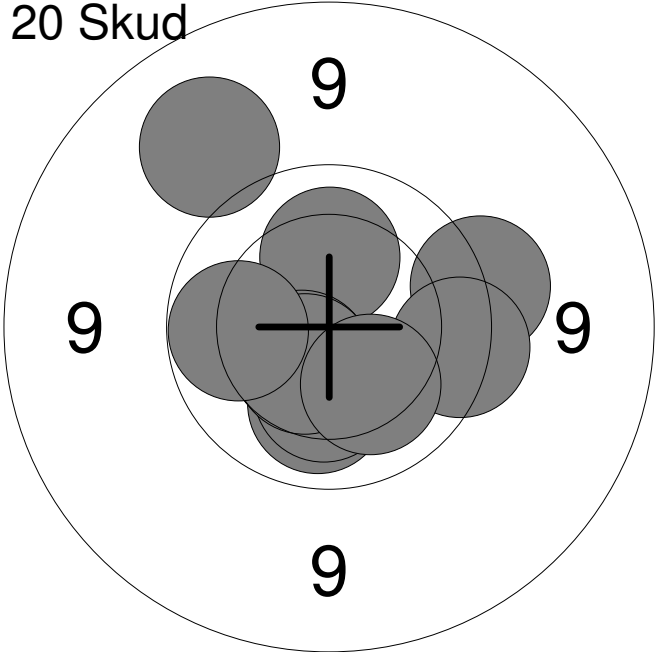
Hold	Skive	Victor D. Mortensen	
10	11	Hjørring Skytteforening	MB3
15m			
30.01.2015	Nordjysk mesterskab 2015	Aalborg Skyttekreds	
Prøve		1: 9.7 ↙	
		2: 10.5x →	
		3: 9.2 →	
		4: 9.5 ↓	
		5: 10.6x ↓	
		6: 10.2 ↓	
		7: 10.1 ↓	
	Serie	67.0	
	Total	0.0	
20 Skud		1: 9.6 ↙	
		2: 10.5 ↙	
		3: 9.7 →	
		4: 9.3 →	
		5: 10.0 →	
		6: 9.2 →	
		7: 9.8 →	
		8: 10.3 →	
		9: 10.1 ↓	
		10: 9.8 ↓	
	Serie	94.0	
	Total	94.0	
20 Skud		11: 10.1 ↓	
		12: 10.2 ↓	
		13: 9.6 →	
		14: 10.2 ↑	
		15: 9.2 ↗	
		16: 10.5 ↙	
		17: 10.5 ↙	
		18: 10.0 ←	
		19: 9.7 →	
		20: 10.2 ↓	
	Serie	97.0	
	Total	191.0	

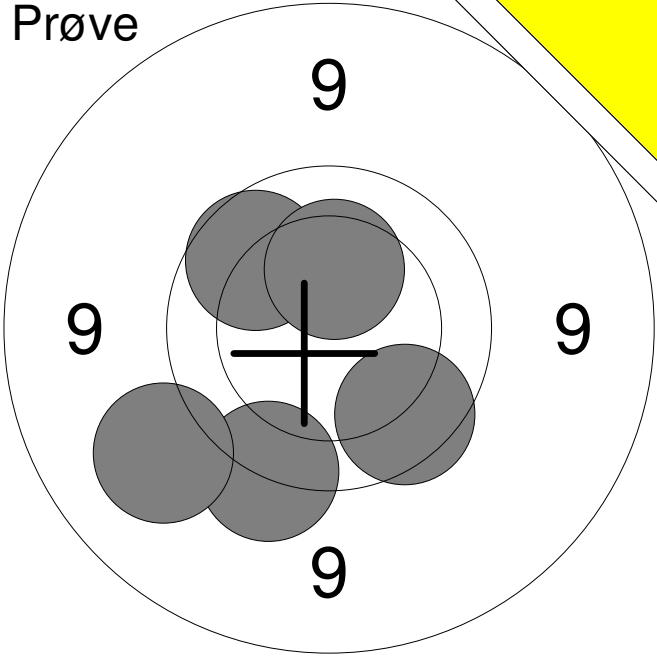
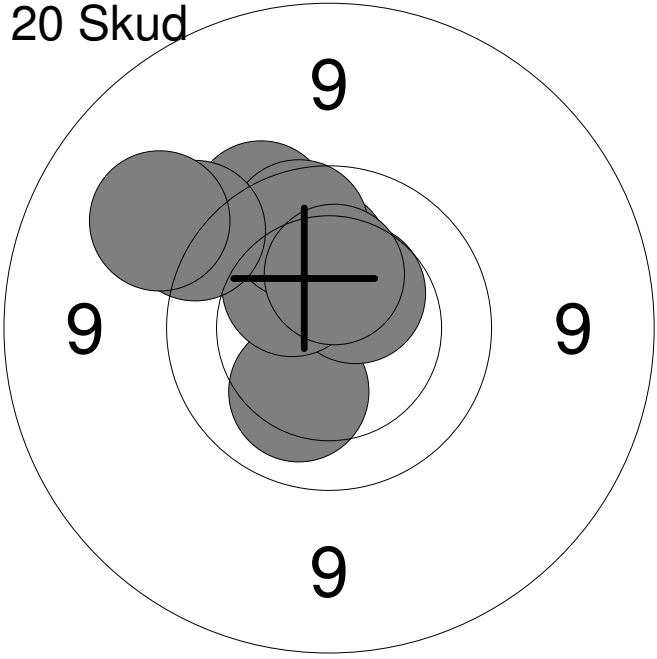
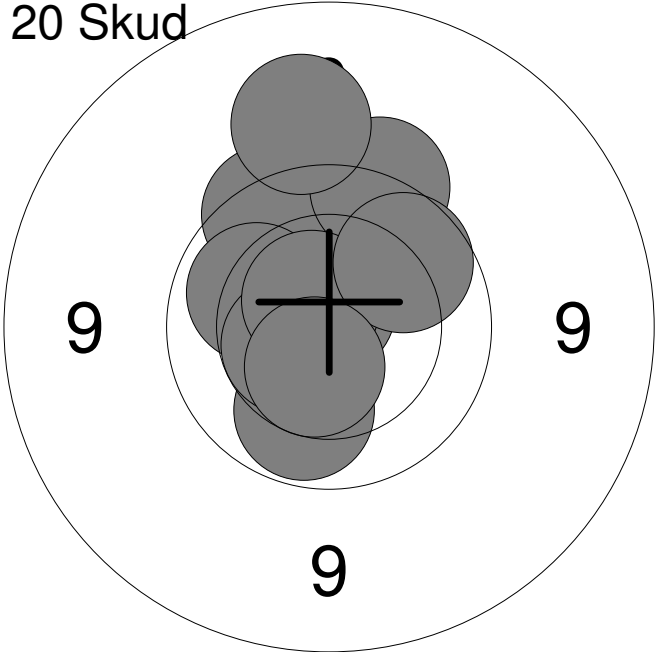

Hold	Skive	Morten Christian Pedersen		
10	12	Hjørring Skytteforening		MB3
30.01.2015	Nordjysk mesterskab 2015		Aalborg Skyttekreds	
Prøve		1:	9.6	↘
		2:	9.2	↙
		3:	9.8	↘
		4:	9.9	↗
		5:	10.3	↑
		<b>Serie</b>	<b>46.0</b>	
		<b>Total</b>	<b>0.0</b>	
20 Skud		1:	10.2	↘
		2:	9.7	↗
		3:	10.1	↗
		4:	10.5	↗
		5:	10.2	↑
		6:	10.3	↗
		7:	9.9	↗
		8:	9.5	↗
		9:	9.3	↗
		10:	10.4	↑
		<b>Serie</b>	<b>96.0</b>	
		<b>Total</b>	<b>96.0</b>	
20 Skud		11:	9.7	↗
		12:	10.7x	↑
		13:	9.6	↗
		14:	10.1	↗
		15:	10.0	↘
		16:	10.5x	↙
		17:	9.3	↑
		18:	10.6x	↗
		19:	9.9	↗
		20:	10.5x	↘
		<b>Serie</b>	<b>96.0</b>	
		<b>Total</b>	<b>192.0</b>	

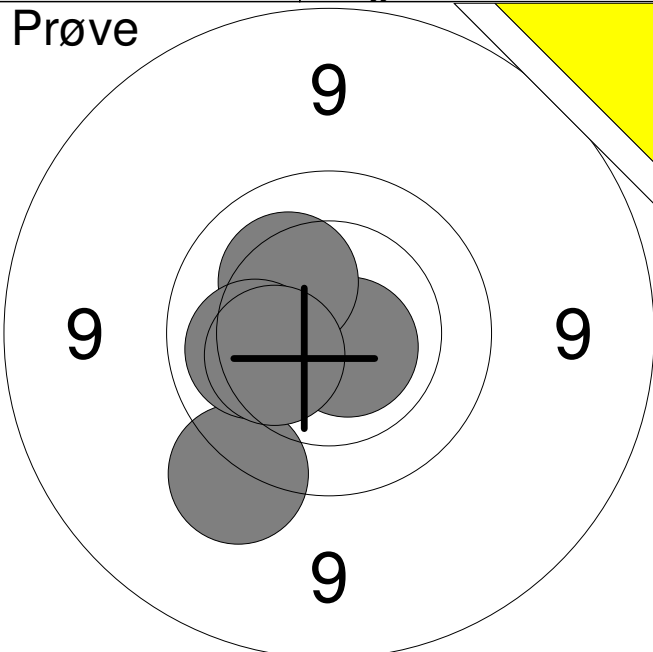
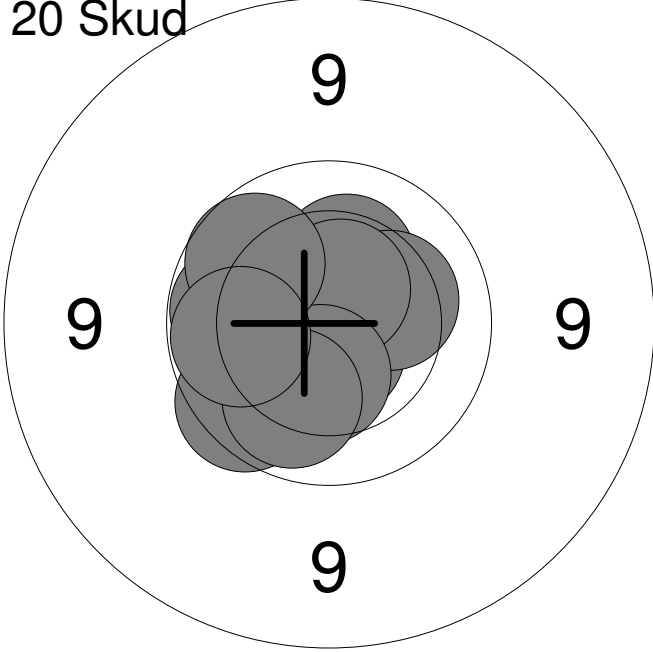
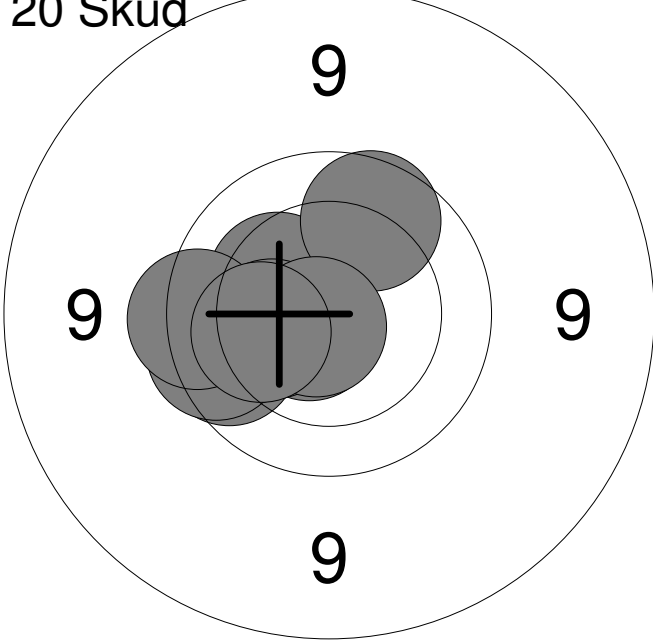
Hold <b>11</b>	Skive <b>2</b>	<b>Thomas Pohl</b>	
15m	Skf. Kimbrene		MB2
30.01.2015	Nordjysk mesterskab 2015	Aalborg Skyttekreds	
Prøve		1: 9.5 ↙	
		2: 10.7x ↘	
		3: 10.2 ↗	
		4: 10.1 ←	
		5: 10.3 ←	
		<b>Serie 49.0</b>	
		<b>Total 0.0</b>	
20 Skud		1: 10.0 ←	
		2: 10.3 ↑	
		3: 10.7x ↓	
		4: 10.3 →	
		5: 10.6x ↑	
		6: 10.4 ↓	
		7: 9.8 ←	
		8: 10.0 ↓	
		9: 9.9 ↗	
		10: 10.0 ←	
		<b>Serie 98.0</b>	
		<b>Total 98.0</b>	
20 Skud		11: 9.9 ←	
		12: 10.0 ←	
		13: 10.7x ←	
		14: 10.3 ↗	
		15: 9.9 ↑	
		16: 10.3 ←	
		17: 9.8 ←	
		18: 10.8x ↙	
		19: 9.7 ←	
		20: 10.2 ←	
		<b>Serie 96.0</b>	
		<b>Total 194.0</b>	

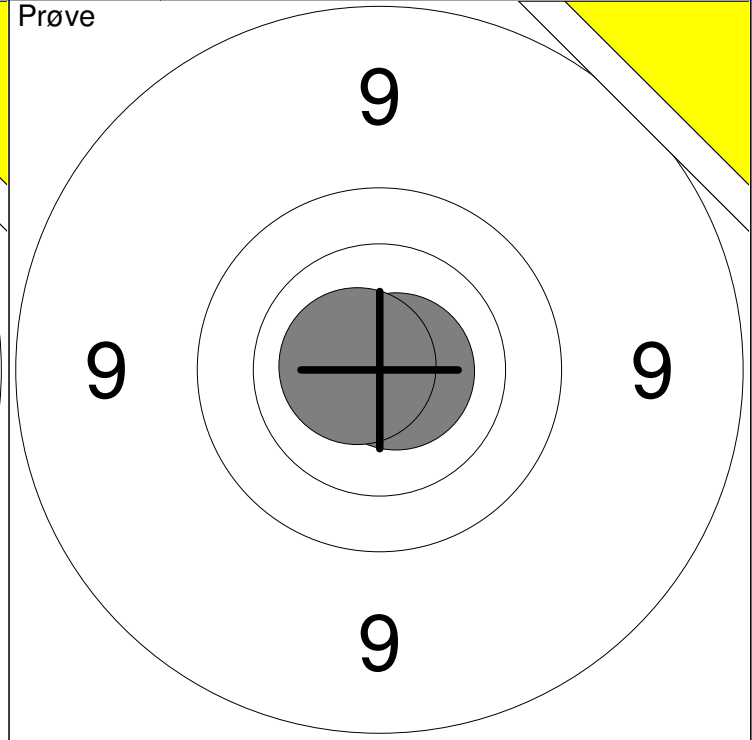
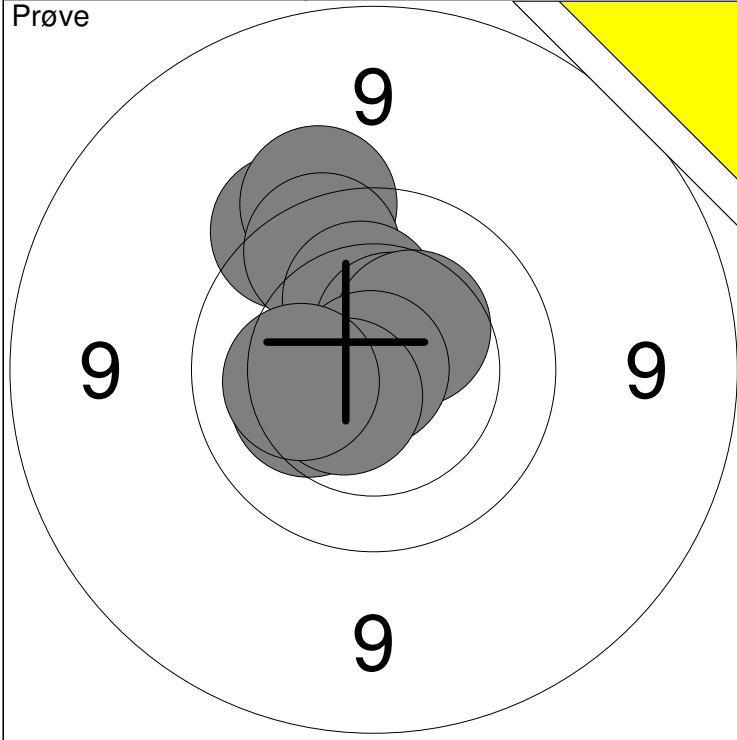

1: 9.6 ↗	6: 10.4 ↗	Serie	97
2: 9.6 ↗	7: 10.9x ←		
3: 9.8 ↗	8: 10.3 ←	Total	0
4: 10.3 ↗	9: 10.6x ↘		
5: 10.5x ↗	10: 10.2 ←		

11: 10.8x →	Serie	20
12: 10.7x ←		
Total		0

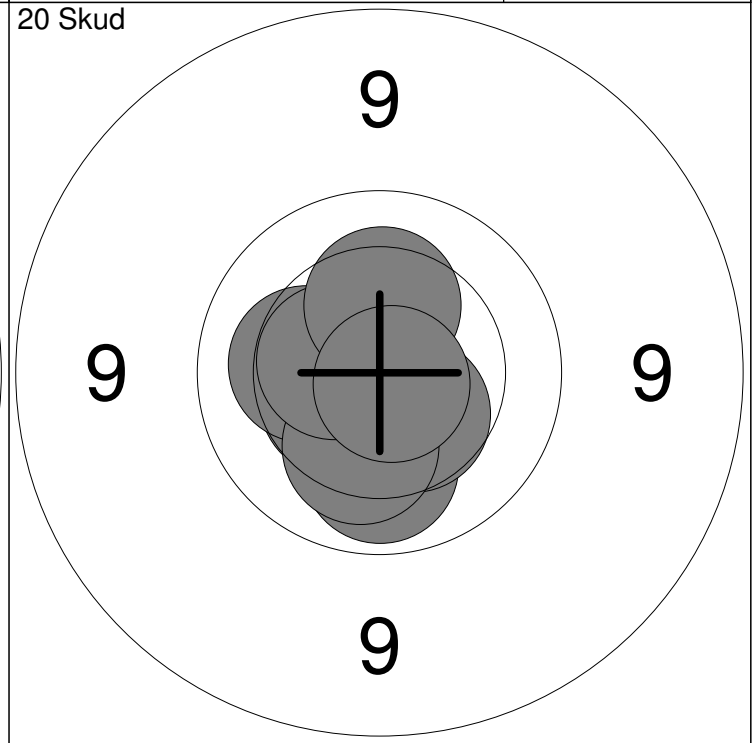
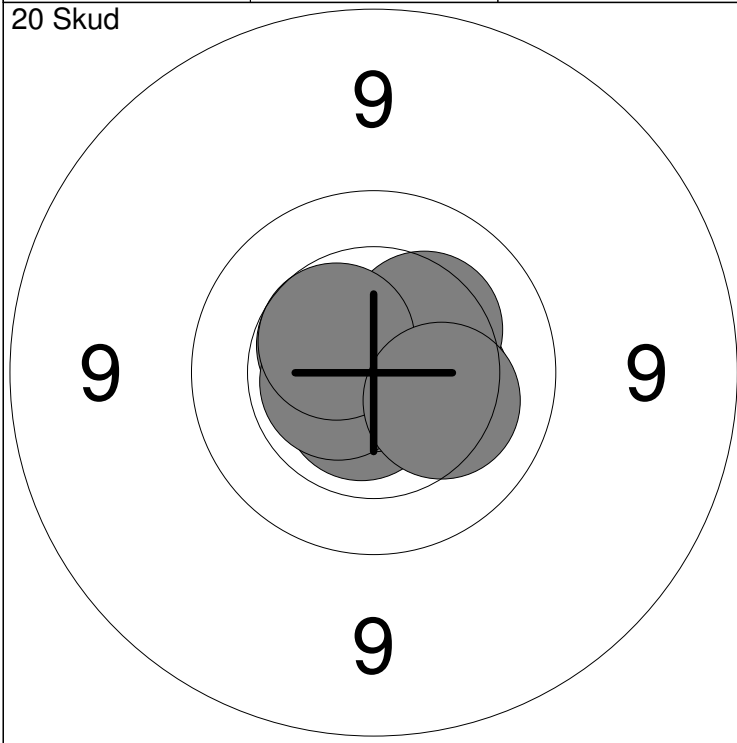

1: 10.5x ↗	6: 10.9x ←	Serie	100
2: 10.4 →	7: 10.6x ←		
3: 10.5x →	8: 10.3 ↗	Total	100
4: 10.6x ↓	9: 10.5 ↗		
5: 10.8x →	10: 10.2 ↘		

11: 10.1 ↓	16: 10.4 ↓	Serie	100
12: 10.5 ←	17: 10.2 ↓		
13: 10.2 ←	18: 10.5x ←	Total	200
14: 10.7x ←	19: 10.3 ↗		
15: 10.5x ↓	20: 10.8x ↘		

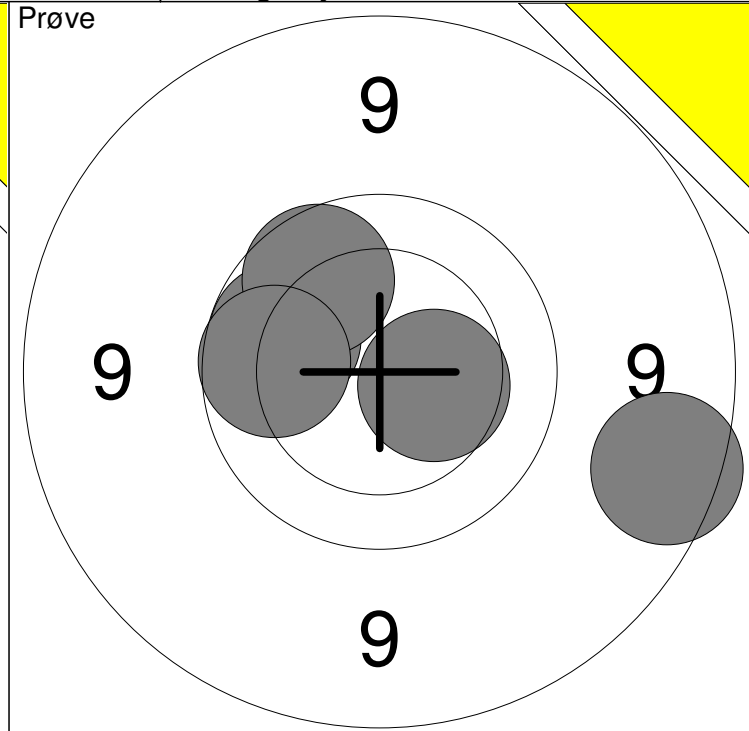
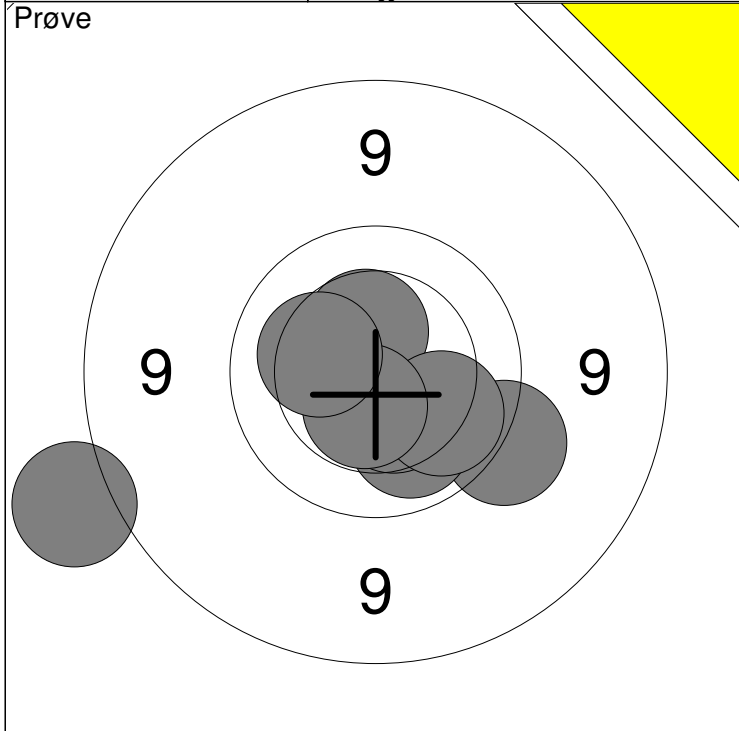

1: 9.5 ↘	6: 10.5 ↗	Serie	97
2: 10.2 ↘	7: 8.5 ↖		
3: 10.1 ↘	8: 10.0 ↘	Total	0
4: 10.4 ↘	9: 10.5x ↘		
5: 10.7x ↗	10: 10.2 ↖		

11: 10.0 ↗	Serie	46
12: 9.9 ↗		
13: 8.9 ↘	Total	0
14: 9.9 ↖		
15: 10.4 ↗		

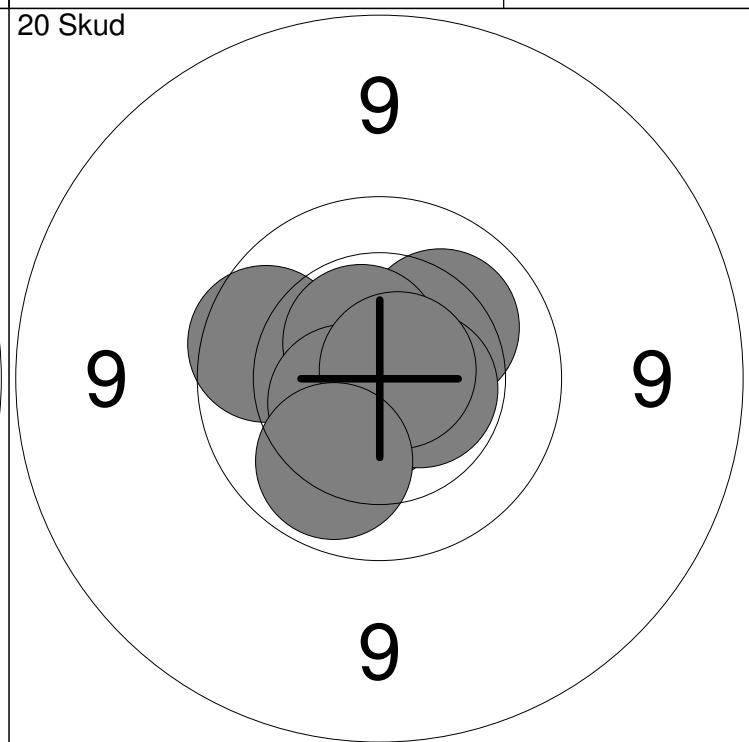
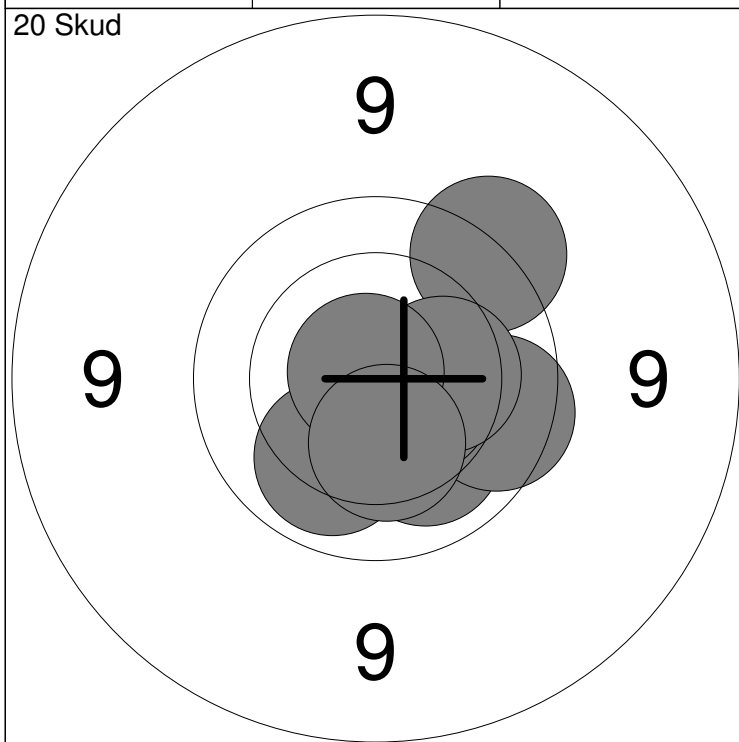

1: 10.1 ↘	6: 10.6x ↘	Serie	98
2: 9.6 ↗	7: 10.3 →		
3: 9.8 →	8: 10.1 ↘	Total	98
4: 10.5x ↘	9: 10.8x ↗		
5: 10.7x ↘	10: 10.3 ↘		

11: 10.7x ↗	16: 10.6x ↗	Serie	99
12: 10.6x ↖	17: 10.6x →		
13: 9.9 ↖	18: 10.6x ↘	Total	197
14: 10.7x ↘	19: 10.8x ↗		
15: 10.2 ↗	20: 10.0 ↘		

Hold	Skive	Mie Marie Lassen	
11	5		
15m	Års Skf.		BK3
30.01.2015	Nordjysk mesterskab 2015	Aalborg Skyttekreds	
Prøve		1: 8.7 ↗	
		2: 9.8 →	
		3: 10.4 ↗	
		Serie	27.0
		Total	0.0
20 Skud		1: 10.5x ↓	
		2: 10.7x ↓	
		3: 9.6 ↓	
		4: 9.6 ↓	
		5: 10.4 ↓	
		6: 9.7 →	
		7: 9.3 ↑	
		8: 10.2 →	
		9: 10.1 ↓	
		10: 9.8 ↙	
		Serie	95.0
		Total	95.0
20 Skud		11: 10.1 ↓	
		12: 10.9x ↑	
		13: 10.6x ↓	
		14: 10.5x ←	
		15: 10.7x ↗	
		16: 10.4 ↗	
		17: 9.9 →	
		18: 10.4 ↓	
		19: 10.7x ↑	
		20: 10.2 ↗	
		Serie	99.0
		Total	194.0

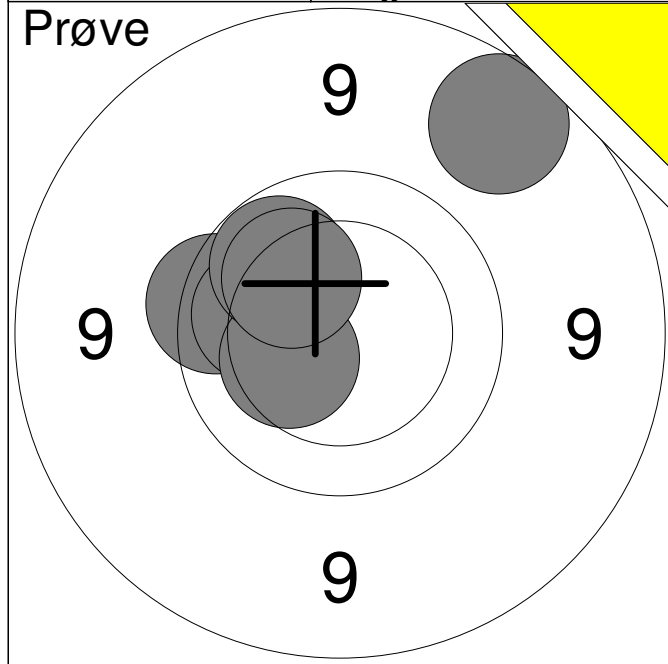

1:	8.9	↗
2:	9.7	←
3:	10.1	←
4:	10.3	↙
5:	10.0	↗
6:	10.2	↗
<b>Serie</b>		<b>57.0</b>
<b>Total</b>		<b>0.0</b>

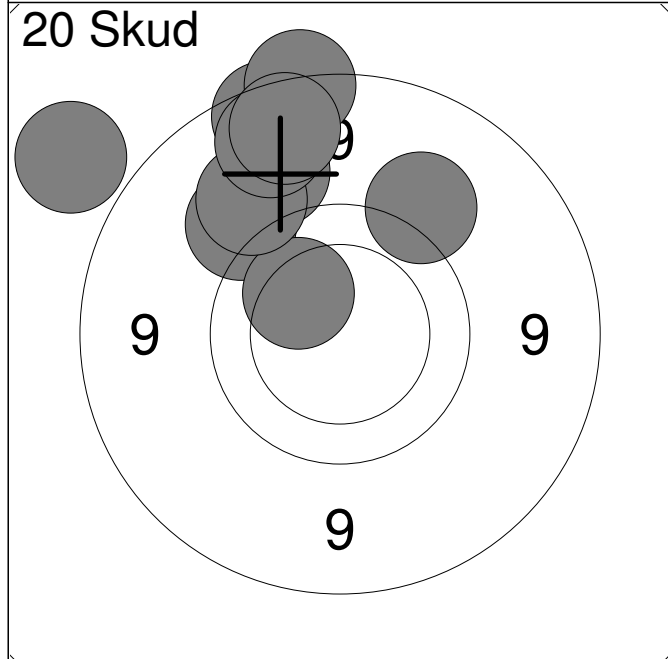

1:	9.4	↗
2:	8.4	↗
3:	10.2	↗
4:	9.2	↗
5:	9.4	↗
6:	8.8	↗
7:	8.7	↗
8:	9.3	↗
9:	9.0	↗
10:	8.9	↗
<b>Serie</b>		<b>87.0</b>
<b>Total</b>		<b>87.0</b>

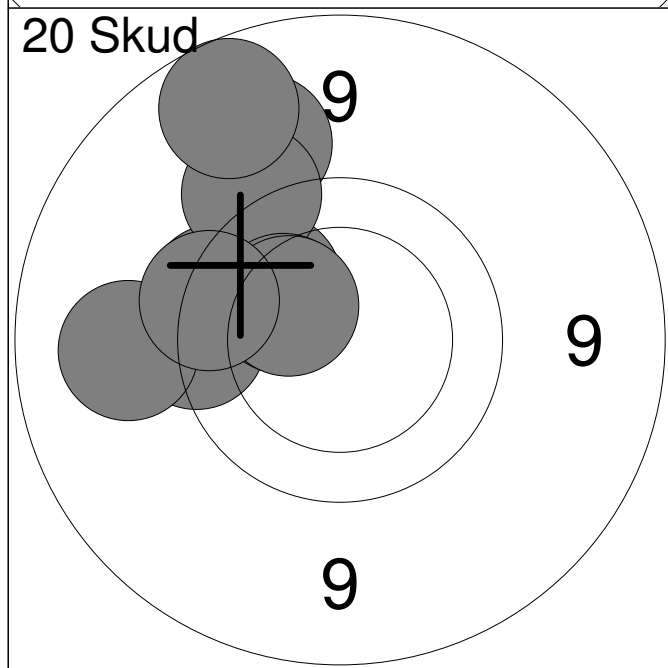

11:	9.7	←
12:	9.6	←
13:	9.2	↗
14:	10.0	↗
15:	9.5	↗
16:	8.9	↗
17:	9.2	←
18:	10.2	↗
19:	10.3	↗
20:	9.7	←
<b>Serie</b>		<b>92.0</b>
<b>Total</b>		<b>179.0</b>

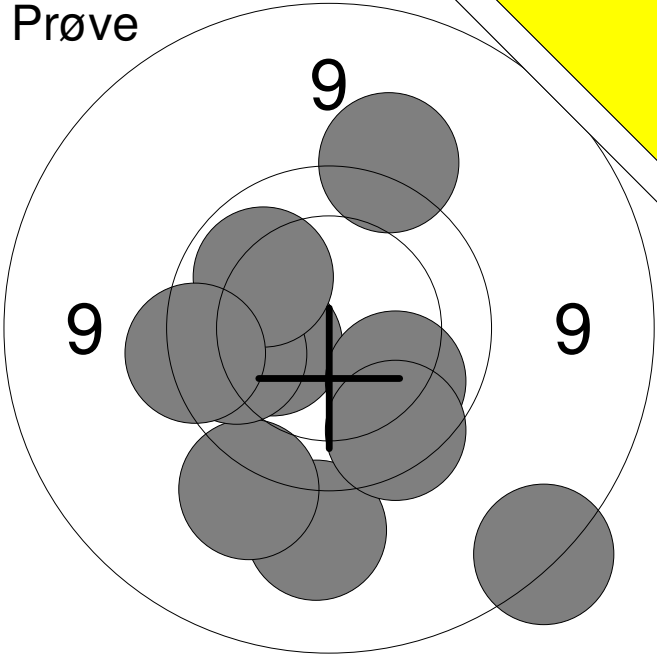
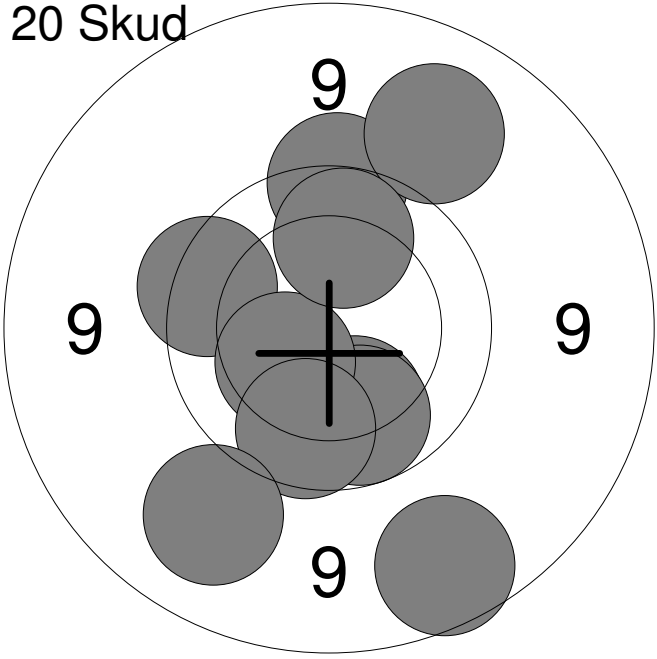
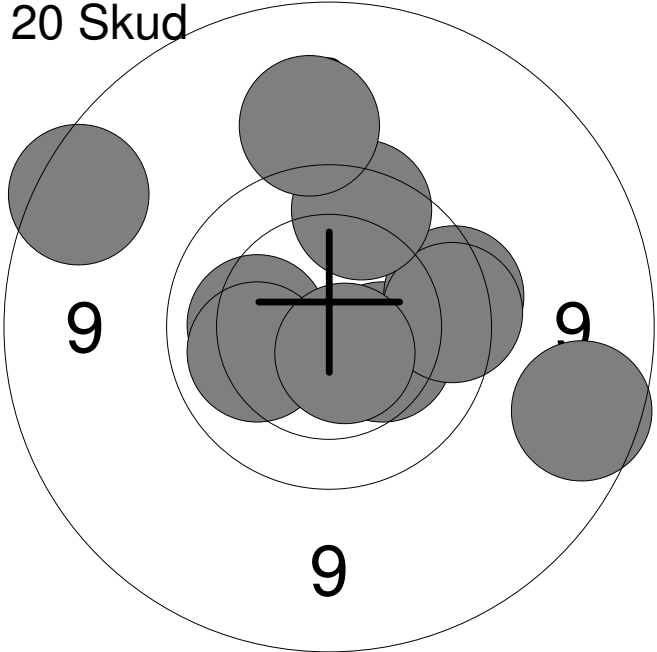
Hold	Skive	Lasse Dohn		
11	7	Sæby og Omegns Skytteforening		BK3
30.01.2015	Nordjysk mesterskab 2015		Aalborg Skyttekreds	
Prøve				1: 9.3 ↓ 2: 8.7 ↓ 3: 9.4 ↓ 4: 10.3 ← 5: 9.9 ← 6: 10.0 ↓ 7: 9.4 ↑ 8: 9.8 ↓ 9: 10.0 ↑ 10: 9.7 ←
		Serie		92.0
		Total		0.0
20 Skud				1: 10.1 ↓ 2: 10.0 ↓ 3: 8.9 ↓ 4: 9.6 ↑ 5: 9.7 ← 6: 10.4 ← 7: 9.9 ↓ 8: 9.2 ↑ 9: 9.2 ↓ 10: 10.0 ↑
		Serie		93.0
		Total		93.0
20 Skud				11: 10.3 → 12: 9.7 → 13: 8.8 ↑ 14: 10.2 ← 15: 10.1 ← 16: 8.9 → 17: 9.8 → 18: 10.6x ↓ 19: 9.8 ↑ 20: 9.3 ↑
		Serie		92.0
		Total		185.0

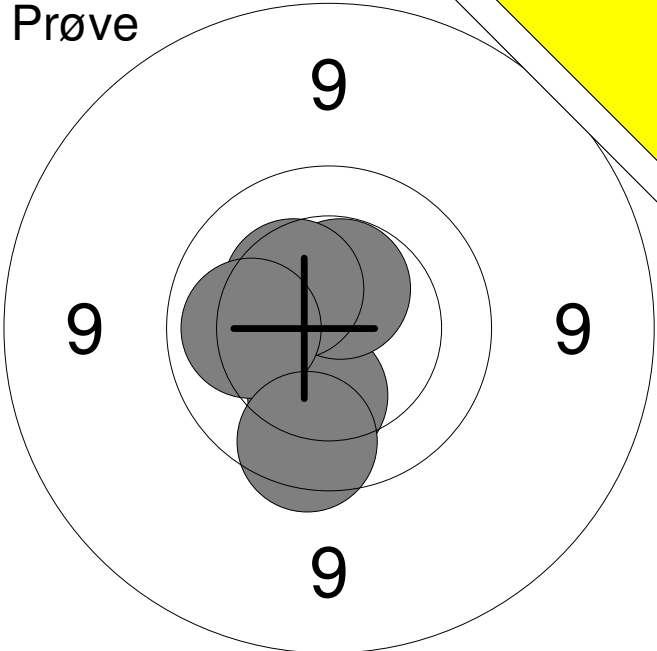
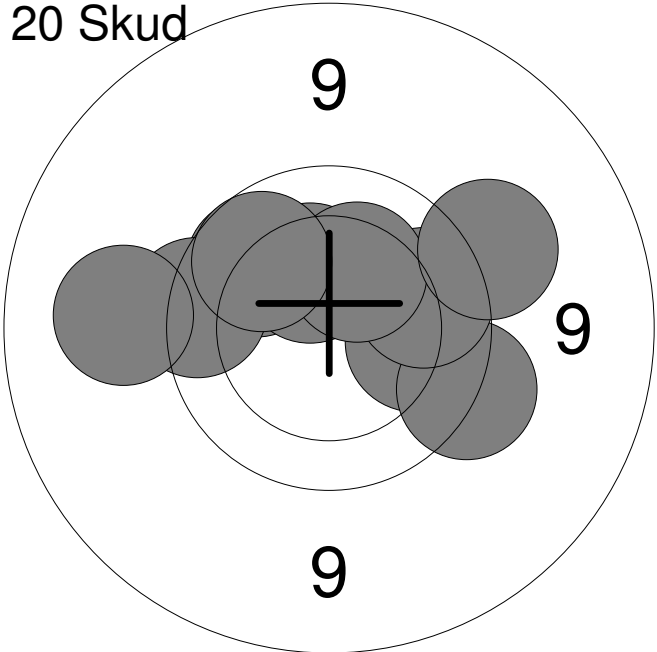
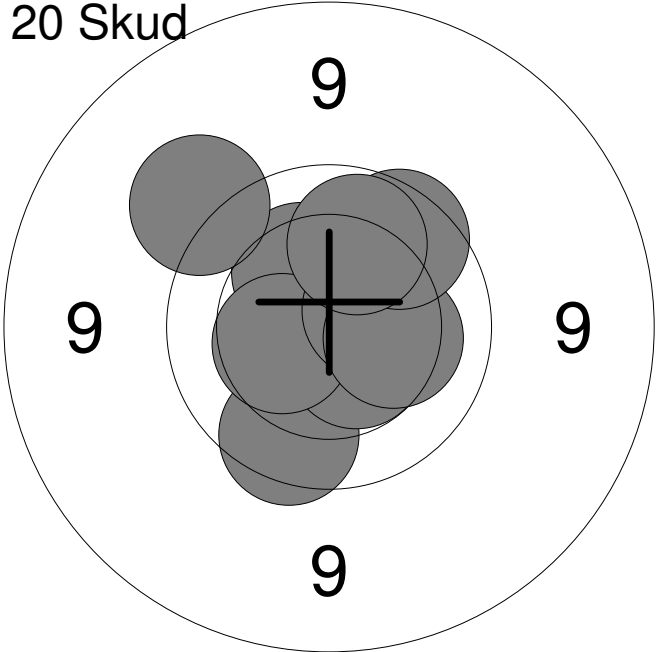
Hold	Skive	Malthe Nielsen		
11	8	Hjørring Skytteforening		MJ2
15m	Nordjysk mesterskab 2015		Aalborg Skyttekreds	
30.01.2015	Prøve		1: 10.2 ↓ 2: 10.5x ↑ 3: 10.4 ↗ 4: 10.1 ← 5: 9.8 ↓	
		Serie	49.0	
		Total	0.0	
20 Skud		1: 9.9 ↗ 2: 10.0 → 3: 10.3 ↗ 4: 9.6 → 5: 9.9 → 6: 10.3 ↗ 7: 9.7 ← 8: 9.2 ← 9: 9.4 → 10: 9.9 ↗		
		Serie	93.0	
		Total	93.0	
20 Skud		11: 10.2 ↗ 12: 9.8 ↓ 13: 10.3 ↗ 14: 10.5x ↓ 15: 10.4 ← 16: 9.4 ↗ 17: 10.4 → 18: 10.2 → 19: 9.8 ↗ 20: 10.0 ↑		
		Serie	97.0	
		Total	190.0	



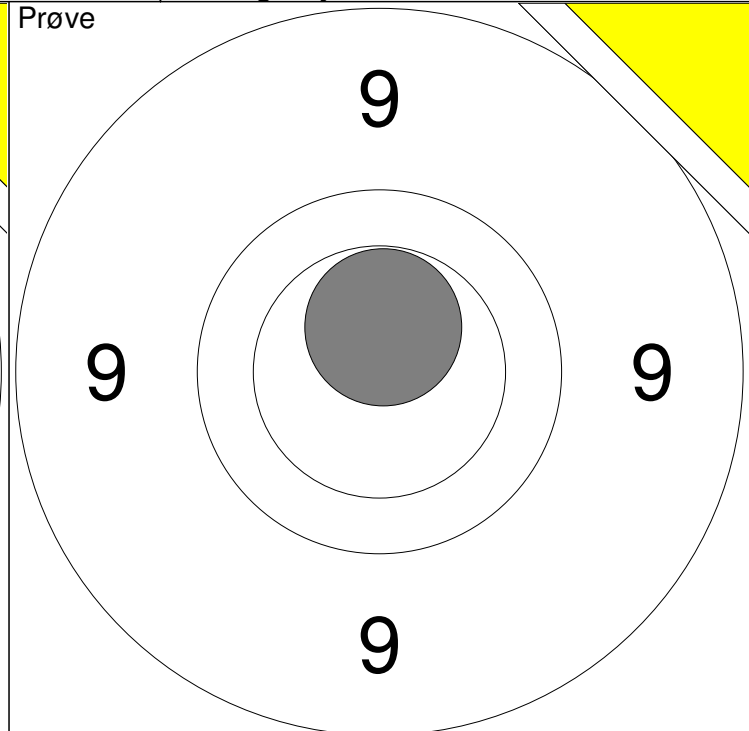
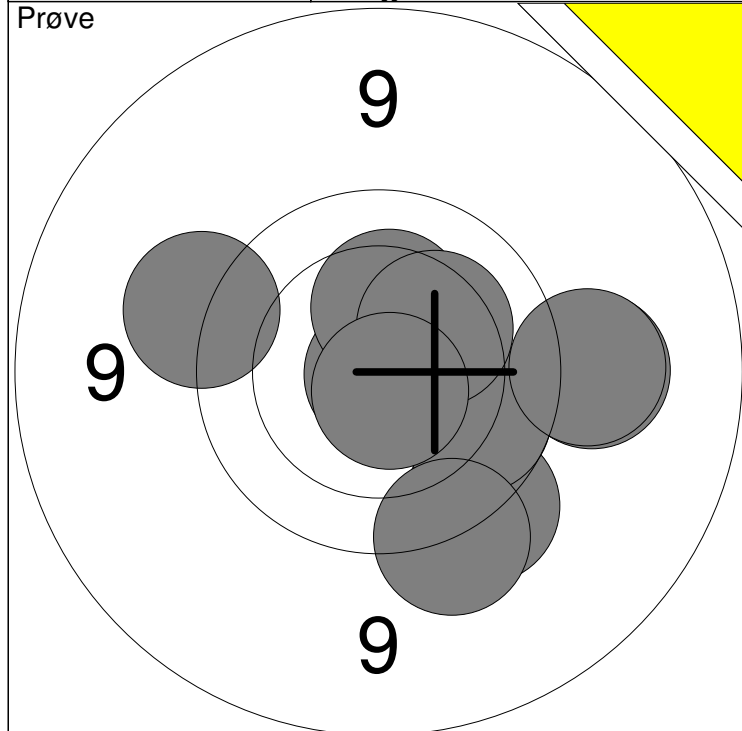

1: 9.3 →	6: 10.3 ↗	Serie	94
2: 10.9x ↘	7: 9.4 →		
3: 10.3 ↑	8: 9.5 ←	Total	0
4: 9.6 ↘	9: 9.5 ↘		
5: 9.9 ↘	10: 10.7x ↘		

11: 10.5x ↑		Serie	10
		Total	0

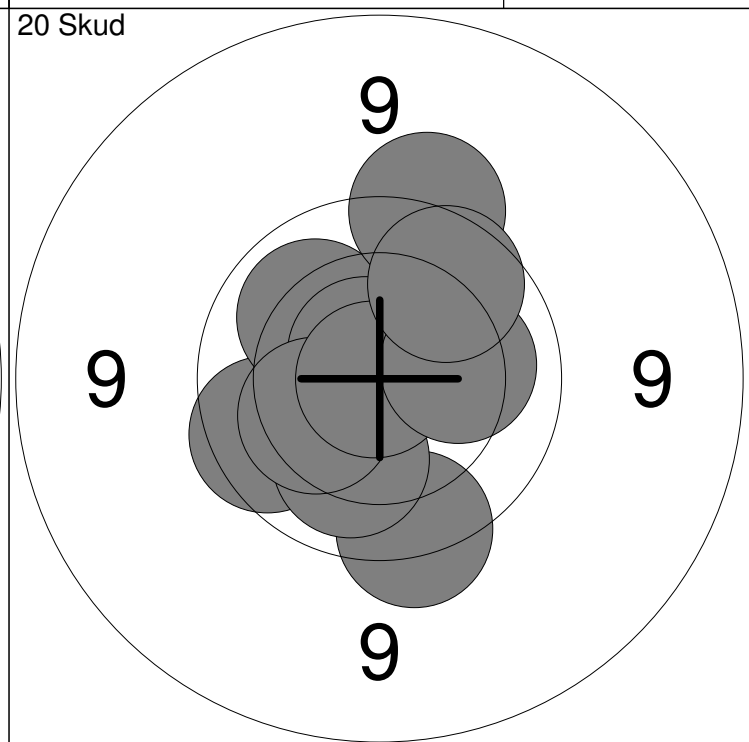
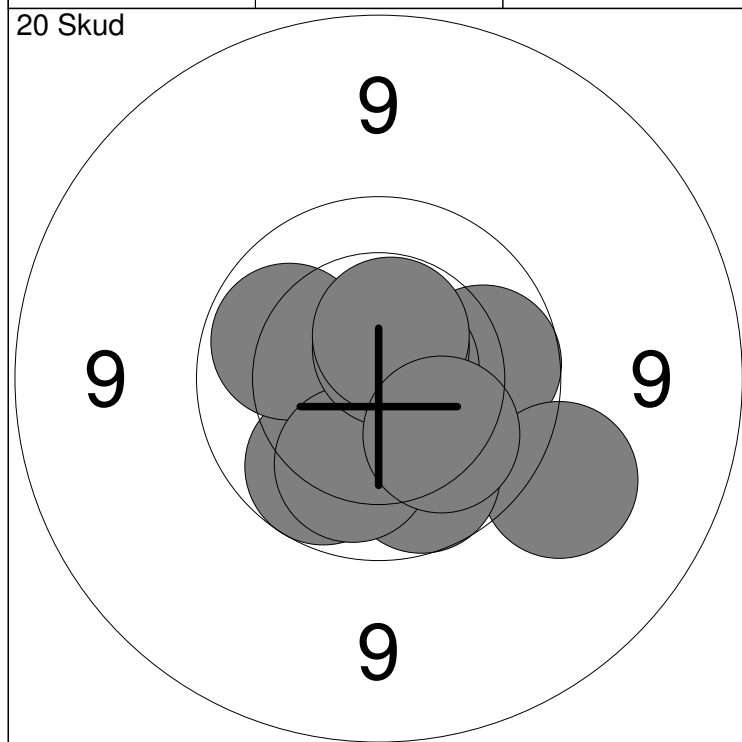

1: 9.9 →	6: 9.9 ↘	Serie	96
2: 9.4 ↘	7: 10.1 ↘		
3: 10.7x →	8: 10.6x ↗	Total	96
4: 9.9 ↘	9: 10.5x ↗		
5: 10.0 ←	10: 10.1 ↘		

11: 9.8 ←	16: 10.2 ←	Serie	96
12: 10.1 ↗	17: 10.9x ←		
13: 9.7 ↘	18: 10.2 →	Total	192
14: 10.1 ↘	19: 9.6 ↗		
15: 10.7x ↗	20: 9.9 ↗		

Hold	Skive	Mathias Haugaard Mikkelsen		
11	10			
15m	Hjørring Skytteforening	MJ1		
30.01.2015	Nordjysk mesterskab 2015	Aalborg Skyttekreds		
Prøve		1:	10.4	↙
		2:	10.5	→
		3:	9.7	→
		4:	10.5x	→
		5:	10.0	→
		6:	10.7x	←
		7:	9.7	→
		8:	10.3	→
		9:	10.3	↓
		Serie		88.0
Total		0.0		
20 Skud		1:	10.5x	↙
		2:	10.5x	↙
		3:	10.0	←
		4:	10.1	↓
		5:	10.6x	↗
		6:	10.0	→
		7:	9.8	→
		8:	10.4	↓
		9:	10.0	↓
		10:	10.1	↓
Serie		99.0		
Total		99.0		
20 Skud		11:	10.2	↓
		12:	10.0	↙
		13:	9.9	↙
		14:	10.0	→
		15:	10.3	↙
		16:	9.8	↓
		17:	10.3	↘
		18:	10.4	←
		19:	9.7	→
		20:	10.3	↘
Serie		97.0		
Total		196.0		

Hold	Skive	Jonas Christian Larsen	
11	11		
15m	Hjørring Skytteforening	MJ2	
30.01.2015	Nordjysk mesterskab 2015	Aalborg Skyttekreds	
Prøve		1: 9.7 ↗	
		2: 9.6 →	
		3: 9.7 ↗	
		4: 9.7 ←	
		5: 10.3 ←	
		6: 9.5 ↑	
		7: 9.9 ↗	
		8: 9.9 ↗	
		9: 9.9 ←	
		<b>Serie</b>	<b>82.0</b>
		<b>Total</b>	<b>0.0</b>
20 Skud		1: 9.7 ↑	
		2: 10.2 ↖	
		3: 9.6 ↗	
		4: 9.4 →	
		5: 9.8 ↙	
		6: 10.5x ↑	
		7: 10.3 ↓	
		8: 10.1 ↗	
		9: 9.9 ↙	
		10: 10.4 →	
		<b>Serie</b>	<b>95.0</b>
		<b>Total</b>	<b>95.0</b>
20 Skud		11: 10.0 ←	
		12: 10.6x ↗	
		13: 10.2 ↑	
		14: 10.3 ↗	
		15: 9.7 ↖	
		16: 9.7 ←	
		17: 9.9 ←	
		18: 10.6x ↙	
		19: 9.7 →	
		20: 10.6x ↗	
		<b>Serie</b>	<b>96.0</b>
		<b>Total</b>	<b>191.0</b>

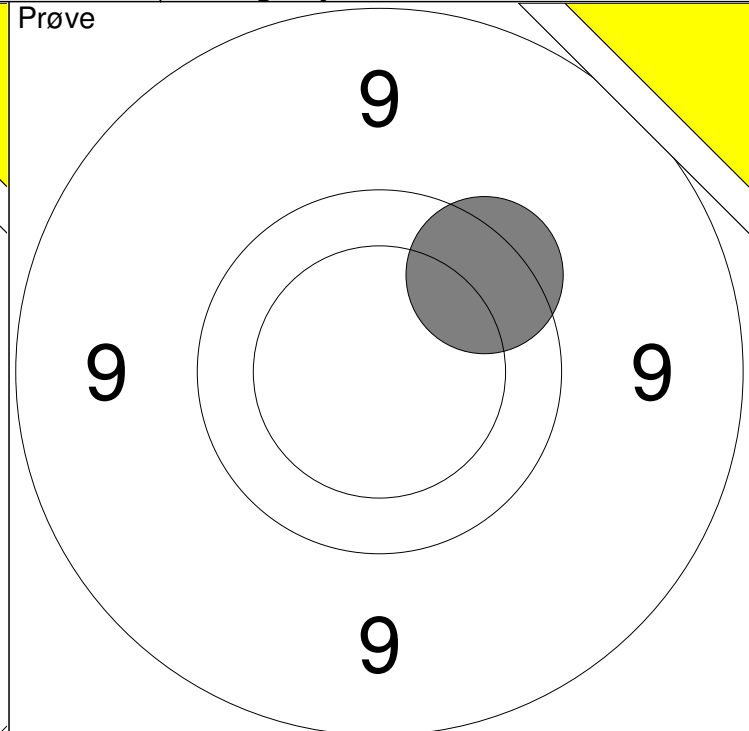
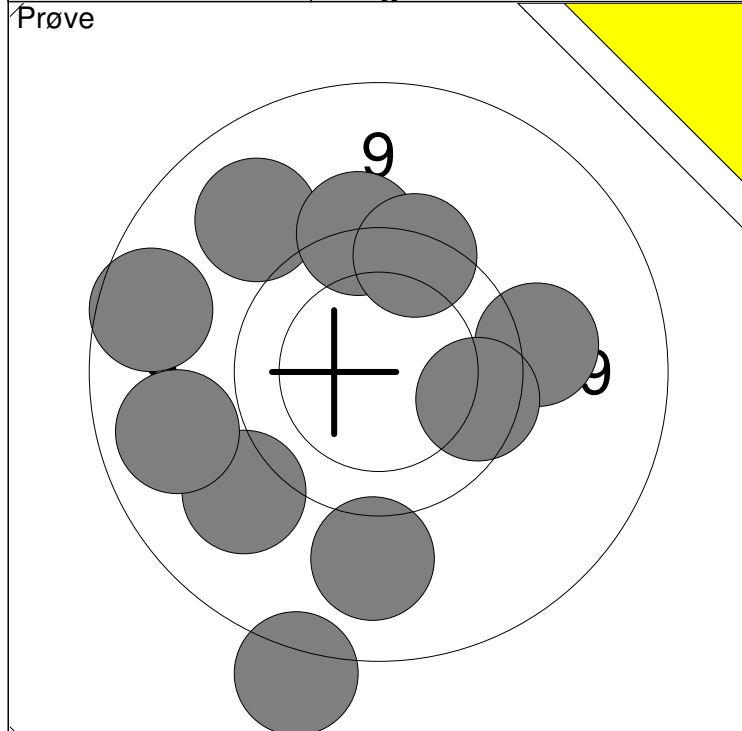

1: 9.3 ↙	6: 9.1 ←	Serie	88
2: 9.2 ↓	7: 8.6 ↓		
3: 9.4 →	8: 9.2 ↗	Total	0
4: 9.8 →	9: 9.6 ↑		
5: 8.9 ←	10: 9.7 ↗		

11: 9.7 ↗	Serie	9
	Total	0

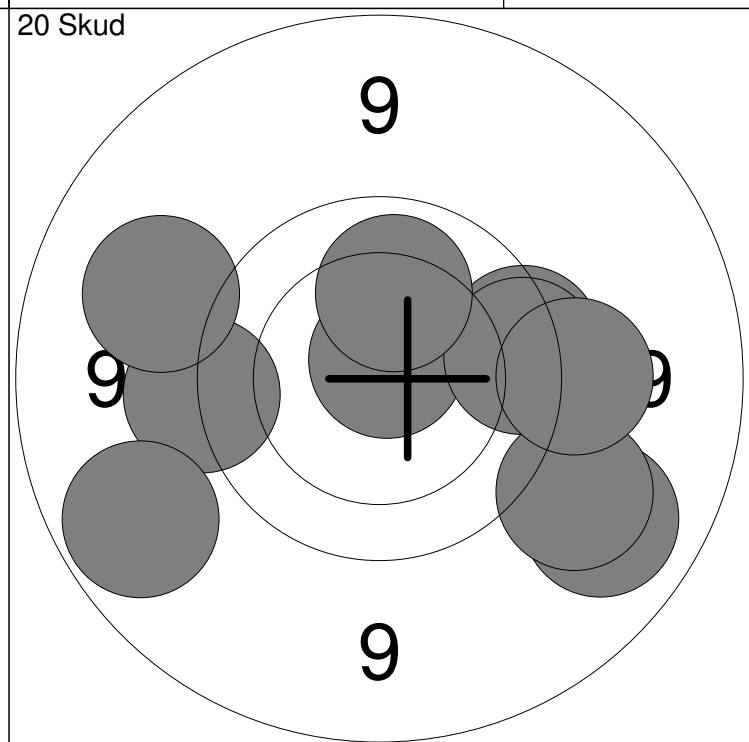
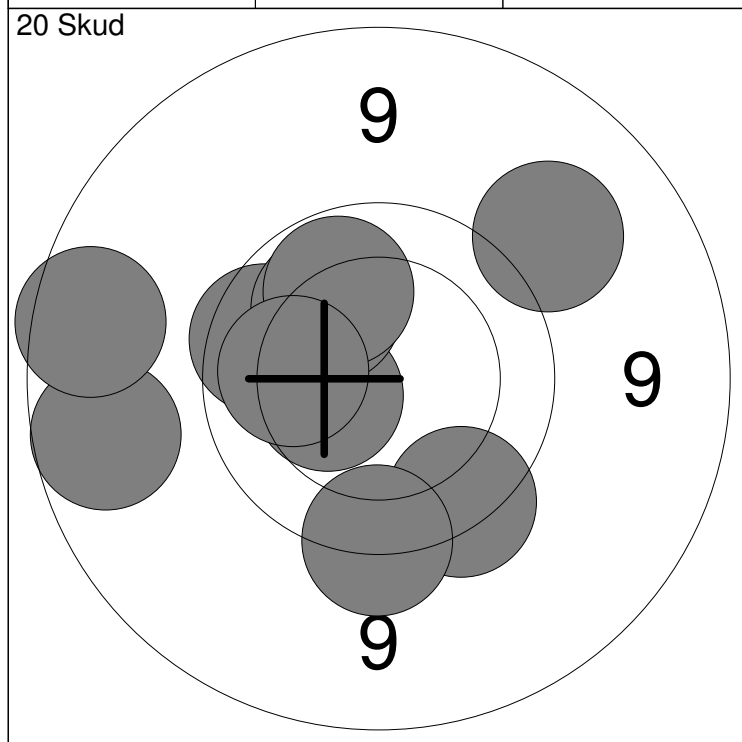

1: 10.4 ←	6: 9.6 ↓	Serie	92
2: 9.8 ←	7: 8.9 ←		
3: 9.3 ↗	8: 10.1 ↗	Total	92
4: 9.7 ↓	9: 10.0 ↑		
5: 8.9 ←	10: 10.1 ←		

11: 9.1 ↘	16: 9.7 →	Serie	92
12: 9.3 ↘	17: 9.2 ←		
13: 10.8x ↑	18: 10.1 ↑	Total	184
14: 9.7 →	19: 9.4 →		
15: 9.5 ←	20: 9.0 ←		

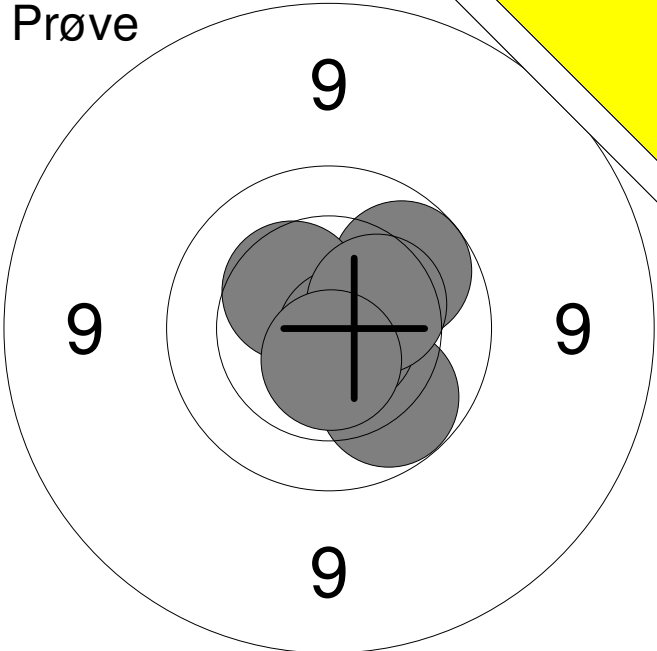
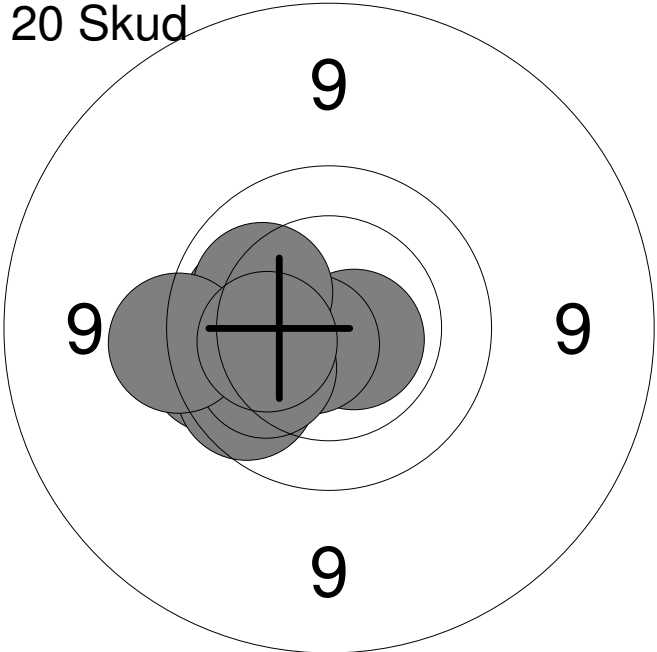
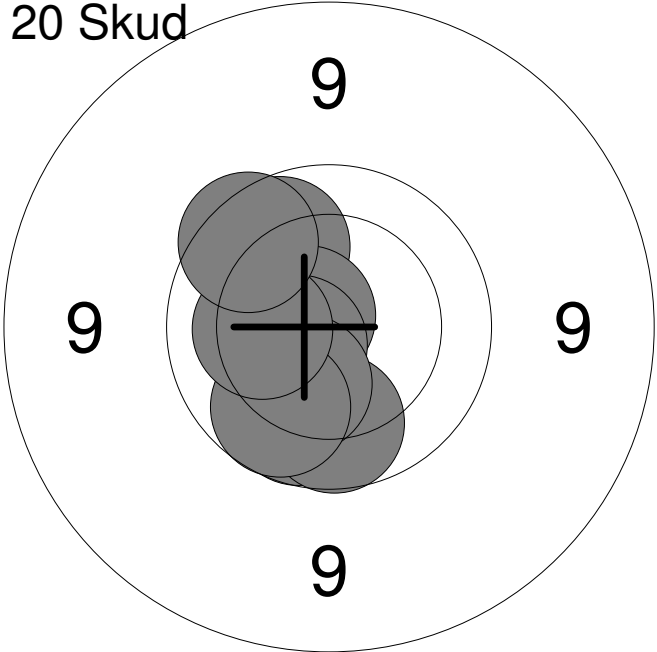
Hold	Skive	Rasmus Greth Sørensen	
12	1	15m	Skf. Kimbrene MB1
30.01.2015	Nordjysk mesterskab 2015	Aalborg Skyttekreds	
Prøve		1: 10.0	↘
		2: 10.0	↗
		3: 10.4	↗
		4: 10.7x	↘
		5: 10.4	↗
		6: 10.6x	↘
		<b>Serie</b>	<b>60.0</b>
		<b>Total</b>	<b>0.0</b>
20 Skud		1: 9.9	←
		2: 10.7x	→
		3: 10.1	←
		4: 10.7x	↙
		5: 10.1	↗
		6: 9.8	←
		7: 9.9	↙
		8: 10.1	↙
		9: 9.6	←
		10: 10.3	←
		<b>Serie</b>	<b>96.0</b>
		<b>Total</b>	<b>96.0</b>
20 Skud		11: 9.9	↗
		12: 9.9	↘
		13: 10.1	↘
		14: 10.7x	↗
		15: 10.6x	↙
		16: 9.9	↘
		17: 10.3	↘
		18: 9.9	↙
		19: 10.2	←
		20: 9.8	↗
		<b>Serie</b>	<b>95.0</b>
		<b>Total</b>	<b>191.0</b>

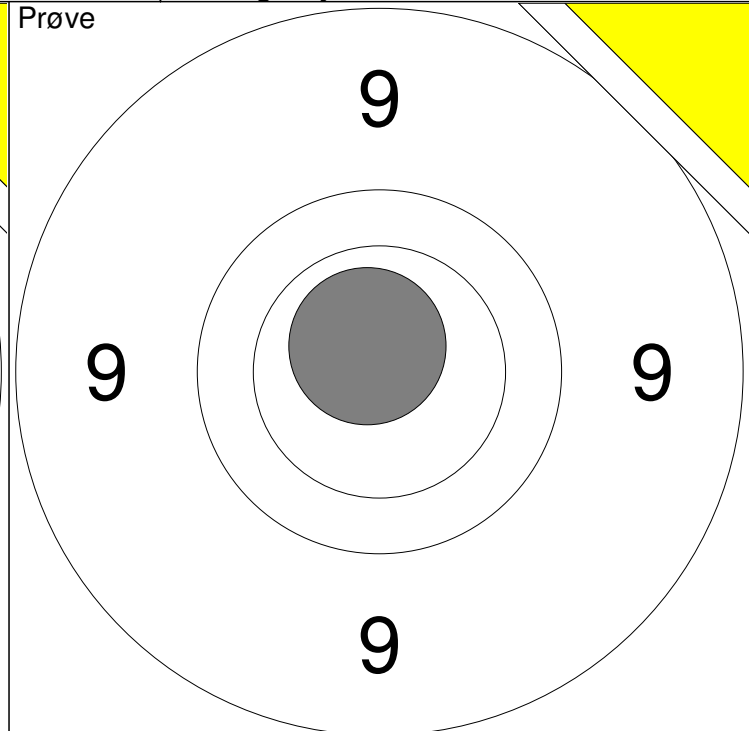
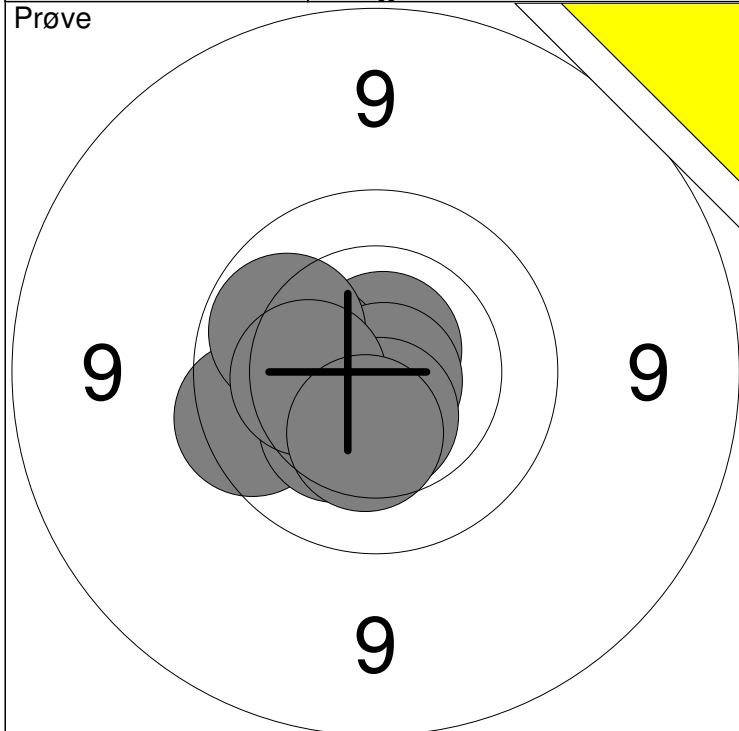

1: 10.5x ←	6: 10.8x ↘	Serie	99
2: 10.7x ↑	7: 10.5x ↓		
3: 9.8 ←	8: 10.0 ←	Total	0
4: 10.3 ←	9: 10.3 ←		
5: 10.3 ↙	10: 10.3 ↓		

11: 10.7x ↗	Serie	10
	Total	0

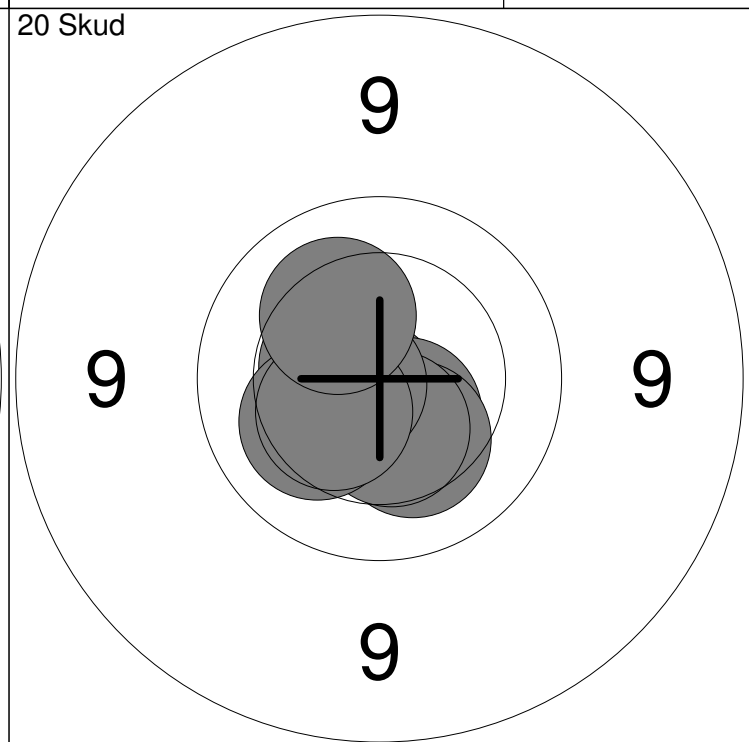
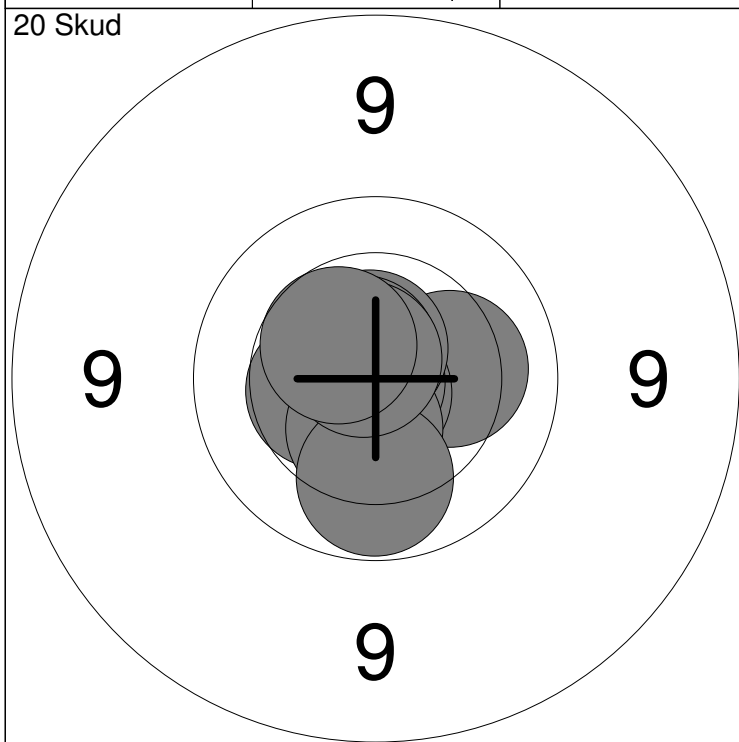

1: 10.2 →	6: 10.5 ↓	Serie	100
2: 10.4 ←	7: 10.0 ↓		
3: 10.8x ↓	8: 10.7x ↗	Total	100
4: 10.9x ←	9: 10.7x ↗		
5: 10.7x ↑	10: 10.5 ↗		

11: 10.7x ↙	16: 10.5 ↓	Serie	100
12: 10.5x ↓	17: 10.2 ←		
13: 10.6x ←	18: 10.6x ←	Total	200
14: 10.5x ←	19: 10.4 ←		
15: 10.3 ↓	20: 10.2 ↘		

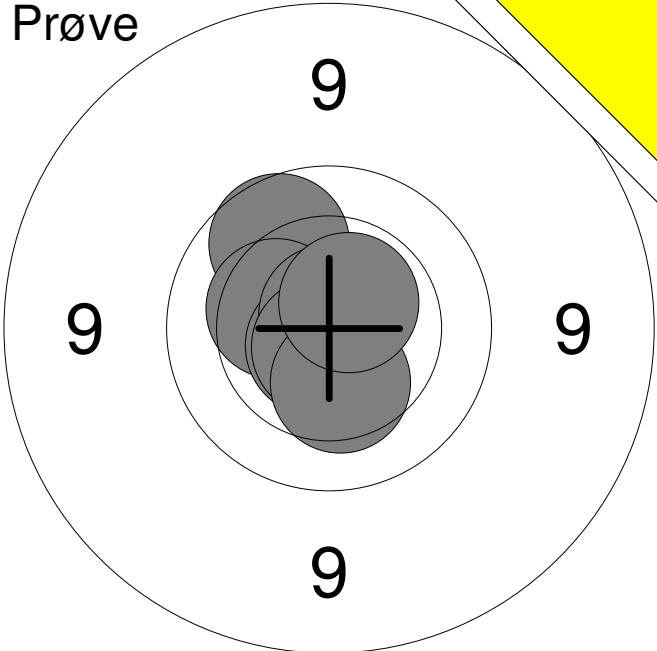
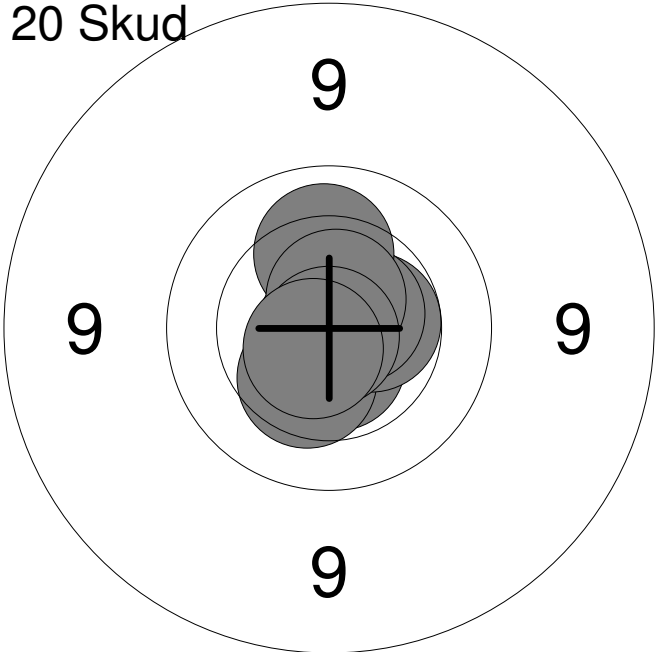
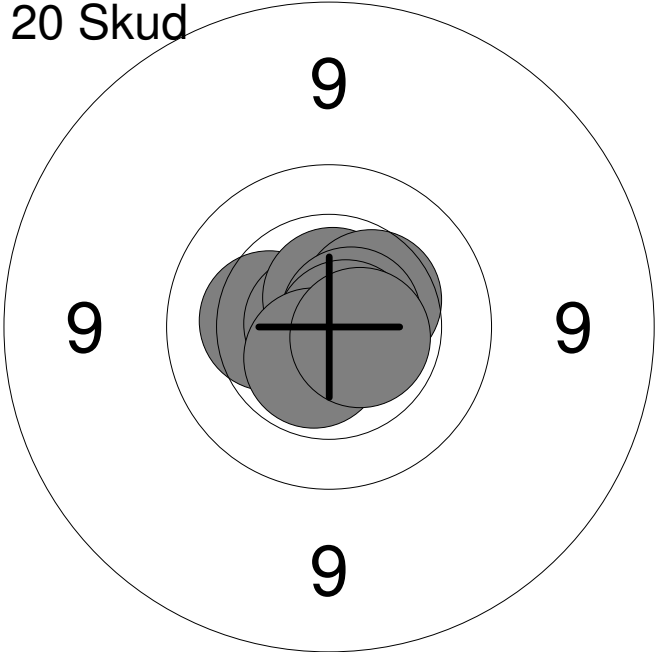
Hold	Skive	Dirch Pedersen	
12	3		
15m	Løgstør Sportsskytteklub	MB1	
30.01.2015	Nordjysk mesterskab 2015	Aalborg Skyttekreds	
Prøve		1: 9.9 ↗	
		2: 10.3 ↖	
		3: 10.7x ↙	
		4: 10.8x ↑	
		5: 10.7x ↘	
		6: 10.4 ↓	
		7: 10.6x ↗	
	Serie	69.0	
	Total	0.0	
20 Skud		1: 10.6x →	
		2: 10.6x ↓	
		3: 10.4 ↘	
		4: 10.5x →	
		5: 10.6x ↗	
		6: 10.9x ↙	
		7: 10.2 ↑	
		8: 10.6x ↑	
		9: 10.9x ↓	
		10: 10.7x ↘	
	Serie	100.0	
	Total	100.0	
20 Skud		11: 10.7x →	
		12: 10.6x ↗	
		13: 10.3 ↖	
		14: 10.8x ↖	
		15: 10.6x ↑	
		16: 10.4 ↗	
		17: 10.7x →	
		18: 10.8x →	
		19: 10.6x ↘	
		20: 10.6x →	
	Serie	100.0	
	Total	200.0	

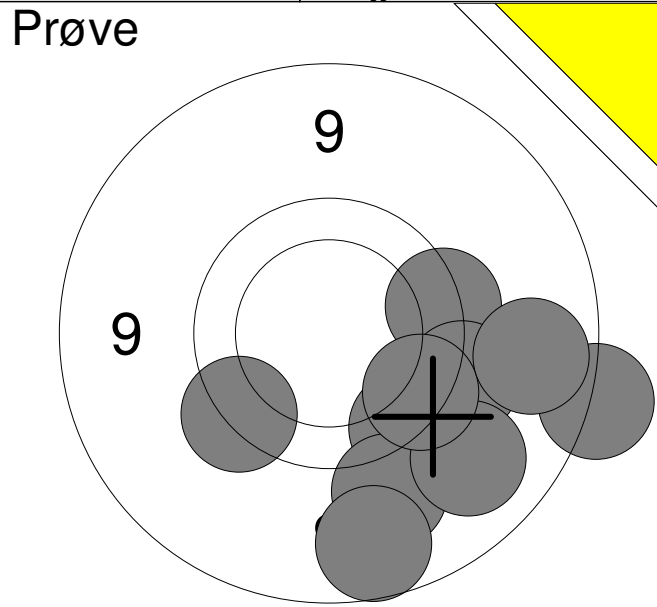
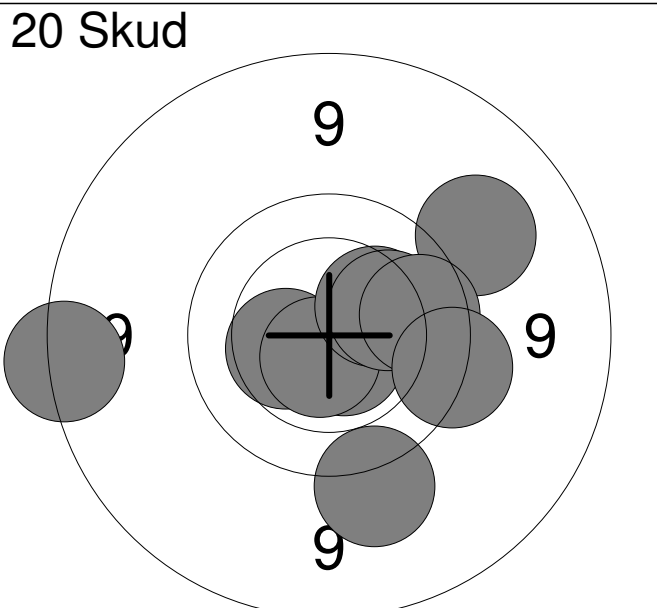
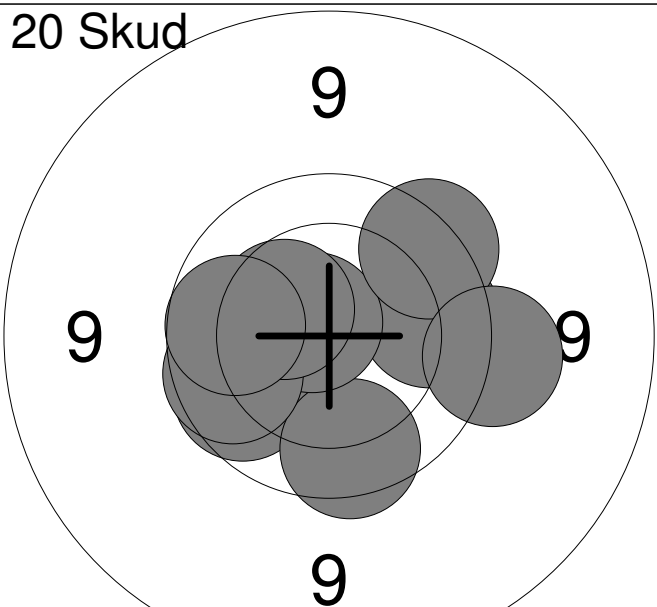
Hold	Skive	Søren Hjørringgaard	
12	4	15m	Års Skf. BK4
30.01.2015	Nordjysk mesterskab 2015	Aalborg Skyttekreds	
<b>Prøve</b> 	1:	9.6	→
	2:	8.6	→
	3:	9.6	↙
	4:	9.3	↙
	5:	8.9	↙
	6:	9.5	→
	7:	9.1	↙
	8:	9.7	↙
	9:	9.6	↙
	10:	9.0	→
	<b>Serie</b>		<b>88.0</b>
<b>Total</b>		<b>0.0</b>	
<b>20 Skud</b> 	1:	9.3	↗
	2:	8.7	←
	3:	10.4	←
	4:	10.6x	↙
	5:	9.4	↙
	6:	10.7x	↙
	7:	10.3	↗
	8:	10.2	→
	9:	9.9	→
	10:	9.6	→
	<b>Serie</b>		<b>94.0</b>
<b>Total</b>		<b>94.0</b>	
<b>20 Skud</b> 	11:	10.2	←
	12:	9.9	→
	13:	9.9	←
	14:	9.8	↙
	15:	10.7x	↗
	16:	9.7	↗
	17:	9.9	←
	18:	10.4	↗
	19:	9.5	→
	20:	9.9	←
	<b>Serie</b>		<b>93.0</b>
<b>Total</b>		<b>187.0</b>	



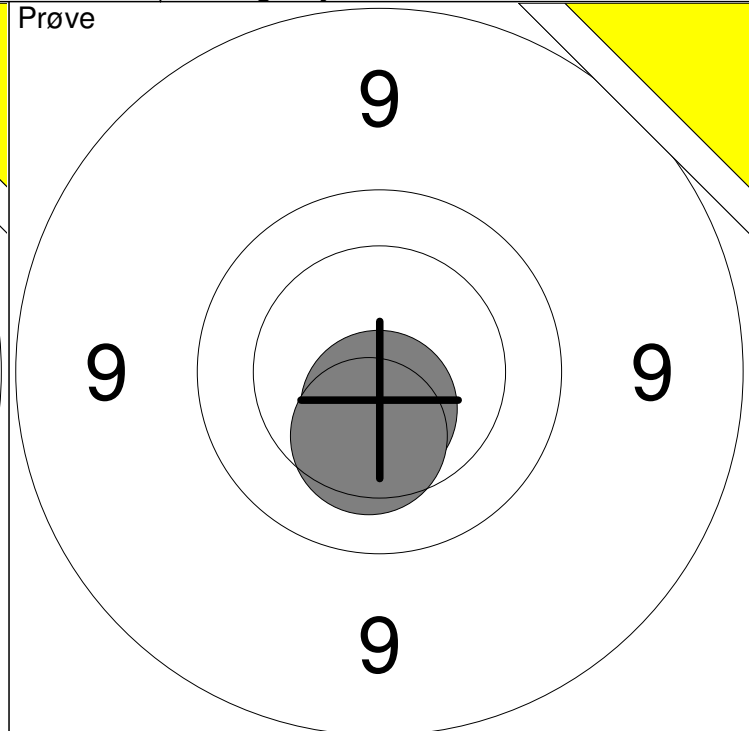
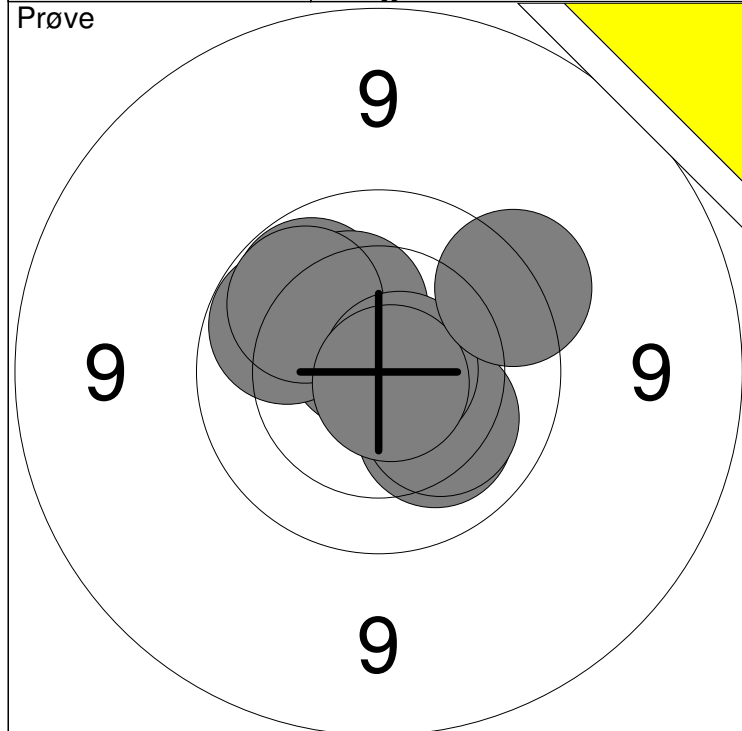

1: 10.0 ↗	6: 10.0 ↗	Serie	99
2: 10.7x ↗	7: 10.2 ↘		
3: 10.3 ↗	8: 10.7x →	Total	0
4: 10.0 ↗	9: 10.8x ↘		
5: 10.2 ↘	10: 9.6 ↗		

11: 10.6x ↓	Serie	20
12: 10.3 ↓		
Total		0

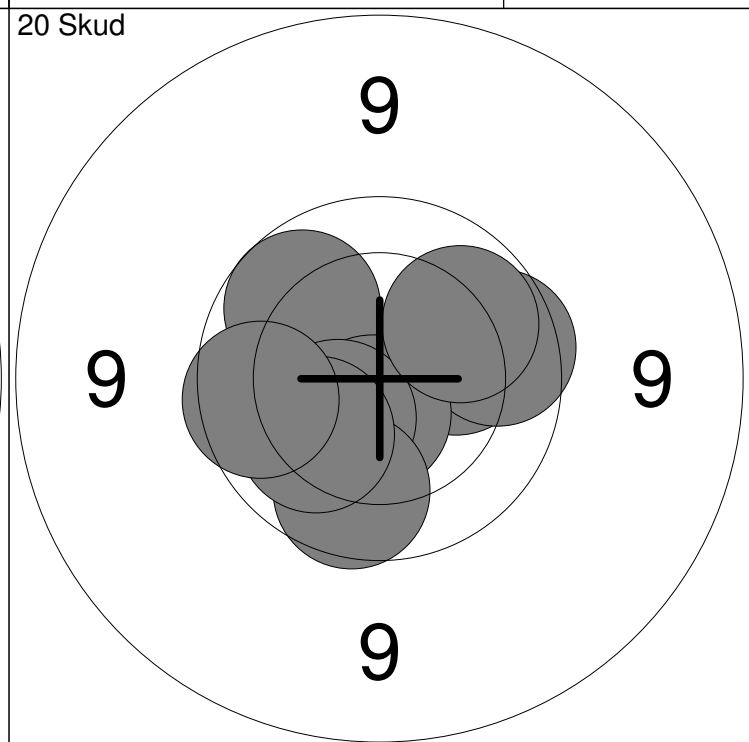
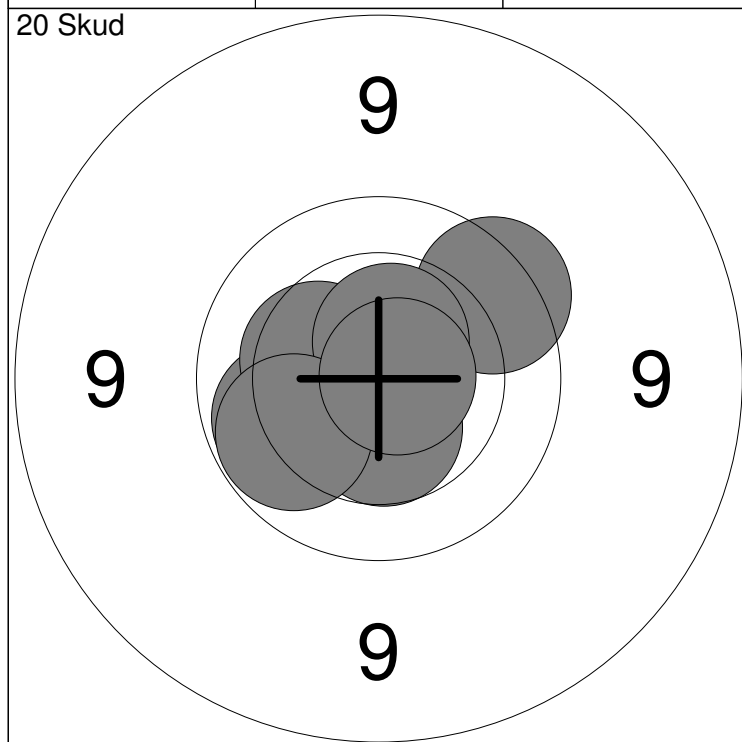

1: 9.7 ↗	6: 10.5 ↓	Serie	99
2: 10.6x ↖	7: 10.3 ↖		
3: 10.0 ↖	8: 10.6x ↗	Total	99
4: 10.8x ↗	9: 10.0 ↖		
5: 10.7x ↓	10: 10.8x →		

11: 10.2 →	16: 10.4 ↖	Serie	96
12: 9.8 →	17: 9.9 ↓		
13: 10.6x ↘	18: 10.0 ↗	Total	195
14: 9.9 ↖	19: 10.1 ↖		
15: 10.6x ↓	20: 9.9 ↖		

Hold	Skive	Thea Key Hald		
12	6	Vilsted Skf.		MB1
30.01.2015	Nordjysk mesterskab 2015		Aalborg Skyttekreds	
Prøve		1:	9.3	↘
		2:	10.7x	↗
		3:	10.7x	→
		4:	10.3	↗
		5:	9.9	→
		6:	10.2	↗
		7:	10.1	→
		8:	10.5	↑
		9:	10.7x	↘
		Serie		88.0
Total		0.0		
20 Skud		1:	10.1	↑
		2:	10.3	↗
		3:	10.6x	←
		4:	10.6x	↘
		5:	10.7x	↑
		6:	10.6x	↗
		7:	10.4	→
		8:	10.3	↑
		9:	9.9	↗
		10:	9.8	↑
Serie		98.0		
Total		98.0		
20 Skud		11:	10.3	↓
		12:	10.1	↘
		13:	10.5	→
		14:	10.4	↑
		15:	10.7x	↘
		16:	10.4	←
		17:	10.0	↗
		18:	10.4	→
		19:	10.1	↘
		20:	9.9	↘
Serie		99.0		
Total		197.0		

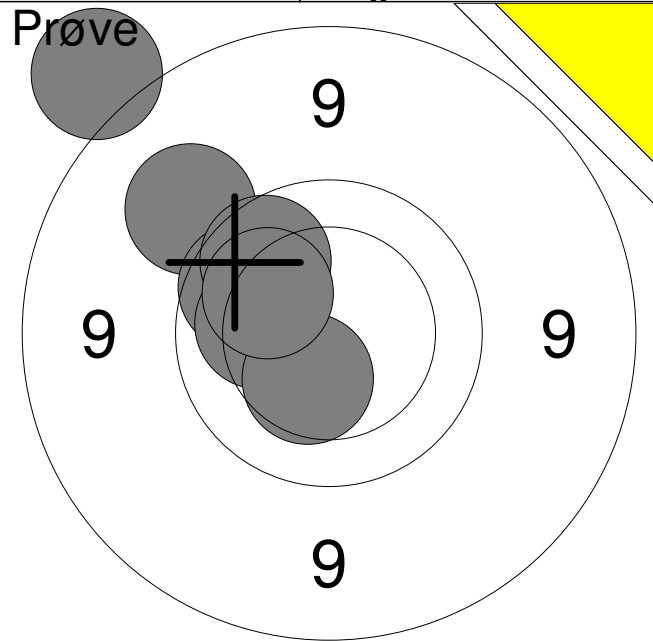
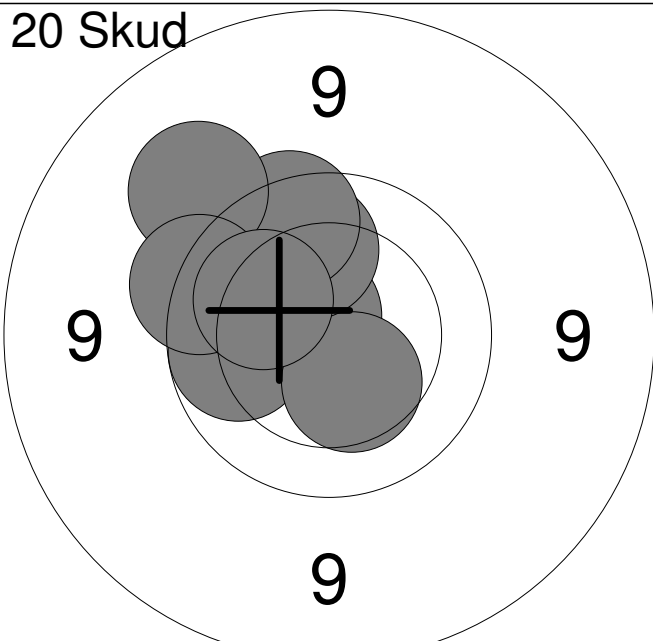
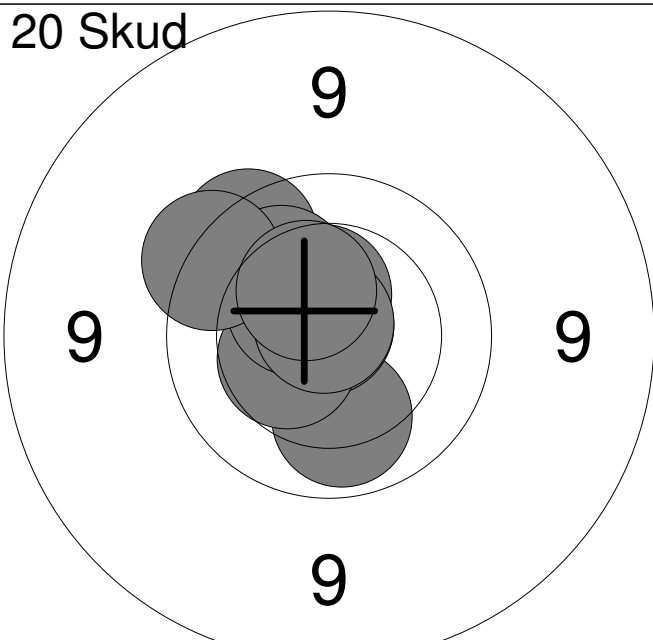
Hold <b>12</b>	Skive <b>7</b>	<b>Natalie Dahl</b>		
15m	Skf. Kimbrene	MJ2		
30.01.2015	Nordjysk mesterskab 2015	Aalborg Skyttekreds		
<b>Prøve</b> 	1:	8.5	↗	
	2:	9.3	↗	
	3:	9.9	↗	
	4:	9.9	↗	
	5:	10.2	↗	
	6:	10.4	↘	
	7:	10.1	↗	
	<b>Serie</b>		<b>65.0</b>	
	<b>Total</b>		<b>0.0</b>	
<b>20 Skud</b> 	1:	10.7x	↗	
	2:	10.2	↖	
	3:	9.8	↗	
	4:	10.0	↖	
	5:	10.4	↘	
	6:	10.0	↗	
	7:	9.8	↗	
	8:	9.3	↗	
	9:	9.7	↗	
	10:	10.1	↗	
	<b>Serie</b>		<b>96.0</b>	
	<b>Total</b>		<b>96.0</b>	
<b>20 Skud</b> 	11:	10.1	↘	
	12:	10.8x	↗	
	13:	9.7	↗	
	14:	10.4	↖	
	15:	10.5x	↗	
	16:	10.1	↗	
	17:	10.5	↗	
	18:	10.8x	↗	
	19:	9.7	↗	
	20:	10.4	↗	
	<b>Serie</b>		<b>98.0</b>	
	<b>Total</b>		<b>194.0</b>	

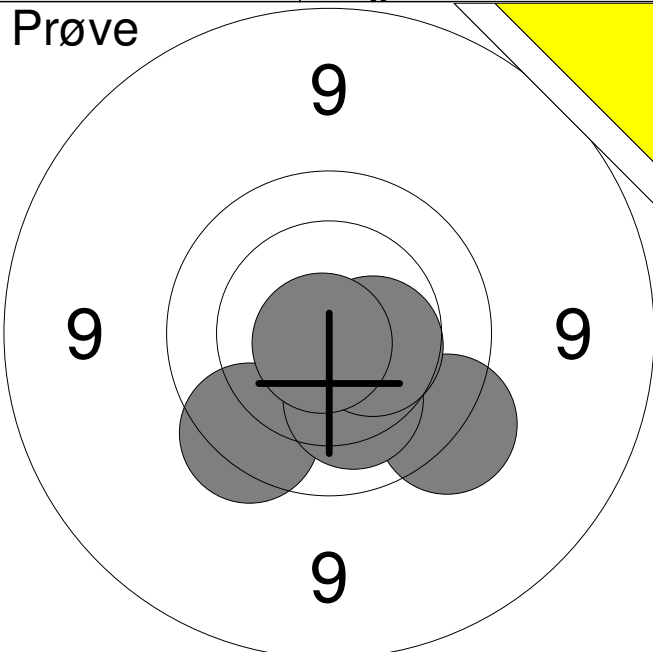
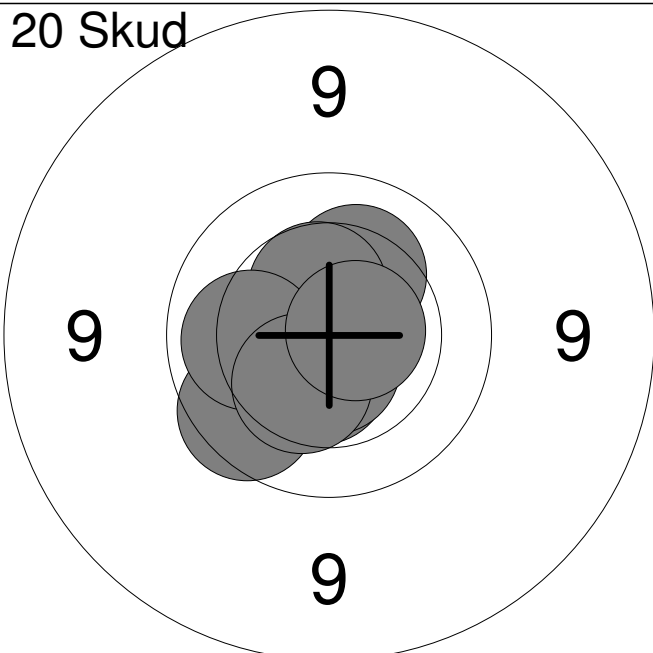
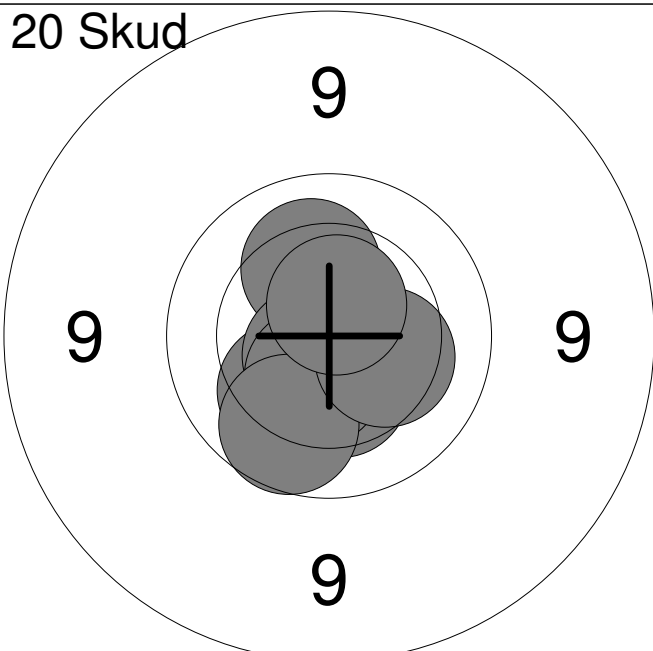
Hold	Skive	Sune Grøn Bendixen	
12	9		
15m	Hjørring Skytteforening	BK2	
30.01.2015	Nordjysk mesterskab 2015	Aalborg Skyttekreds	
Prøve		1: 9.6	↘
		2: 9.7	↘
		3: 10.2	↘
		4: 10.5	→
		5: 10.8x	↘
		<b>Serie</b>	<b>48.0</b>
		<b>Total</b>	<b>0.0</b>
20 Skud		1: 10.9x	↗
		2: 9.8	↘
		3: 10.4	↗
		4: 10.2	↗
		5: 10.5x	↘
		6: 10.5	↗
		7: 10.6x	↘
		8: 10.1	←
		9: 10.4	↘
		10: 10.7x	→
		<b>Serie</b>	<b>99.0</b>
		<b>Total</b>	<b>99.0</b>
20 Skud		11: 10.6x	↘
		12: 10.4	↘
		13: 10.4	↘
		14: 10.2	↘
		15: 10.2	↗
		16: 10.7x	↘
		17: 10.5	↘
		18: 9.9	↘
		19: 10.3	→
		20: 10.6x	↗
		<b>Serie</b>	<b>99.0</b>
		<b>Total</b>	<b>198.0</b>

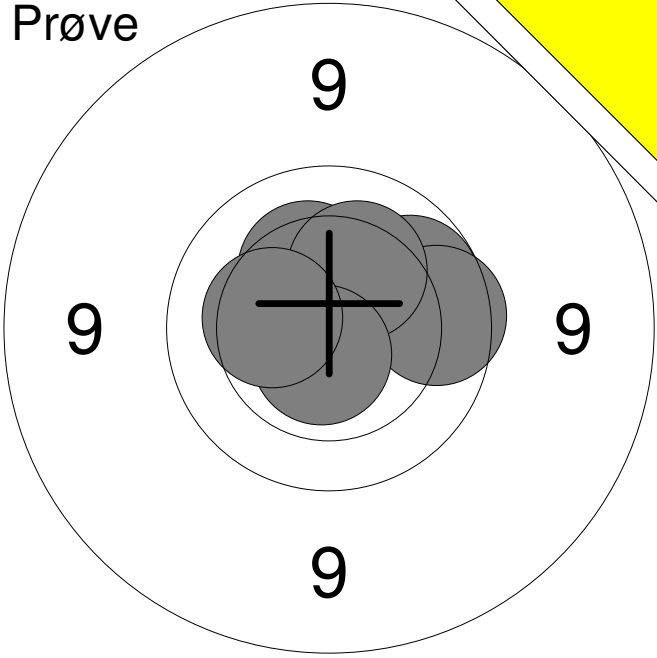
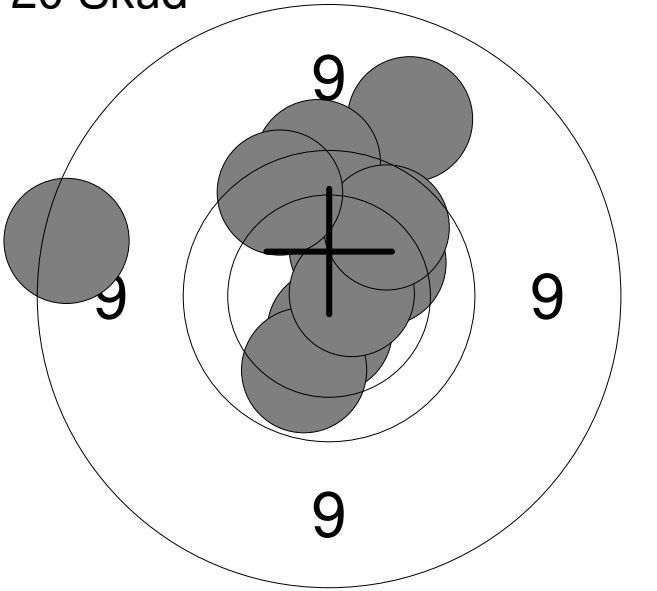
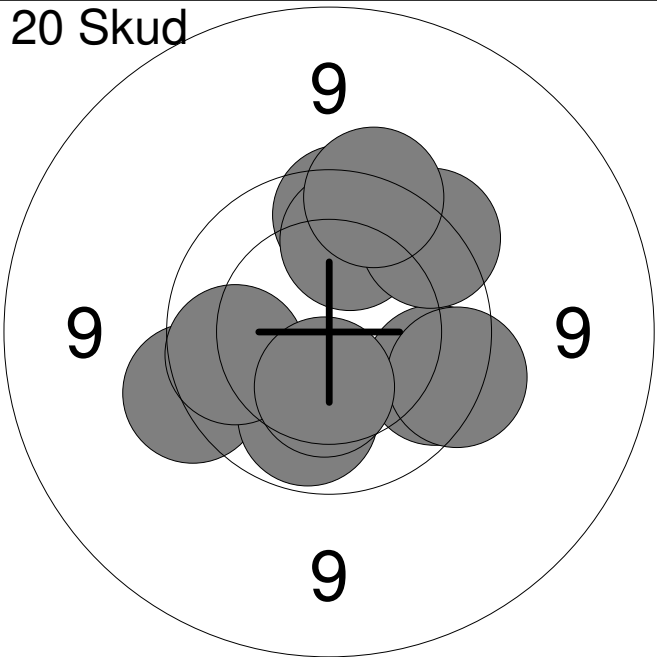
Hold	Skive	Tobias Jørgensen	
12	10		
15m	Sæby og Omegns Skytteforening	MB4	
30.01.2015	Nordjysk mesterskab 2015	Aalborg Skyttekreds	
Prøve		1: 10.0	➔
		2: 10.3	⬆
		3: 9.9	➔
		4: 10.3	⬆
		5: 10.7x	⬇
		6: 10.3	⬅
		<b>Serie</b>	<b>59.0</b>
		<b>Total</b>	<b>0.0</b>
20 Skud		1: 10.5x	⬇
		2: 10.3	⬆
		3: 9.2	⬆
		4: 10.2	➔
		5: 10.0	⬇
		6: 9.6	⬆
		7: 10.7x	➔
		8: 8.8	⬅
		9: 9.9	⬆
		10: 9.7	⬆
		<b>Serie</b>	<b>94.0</b>
		<b>Total</b>	<b>94.0</b>
20 Skud		11: 9.8	⬆
		12: 9.8	➔
		13: 9.6	⬅
		14: 9.9	⬆
		15: 9.7	➔
		16: 10.0	⬇
		17: 9.9	⬅
		18: 9.6	⬆
		19: 9.7	➔
		20: 10.4	⬇
		<b>Serie</b>	<b>92.0</b>
		<b>Total</b>	<b>186.0</b>

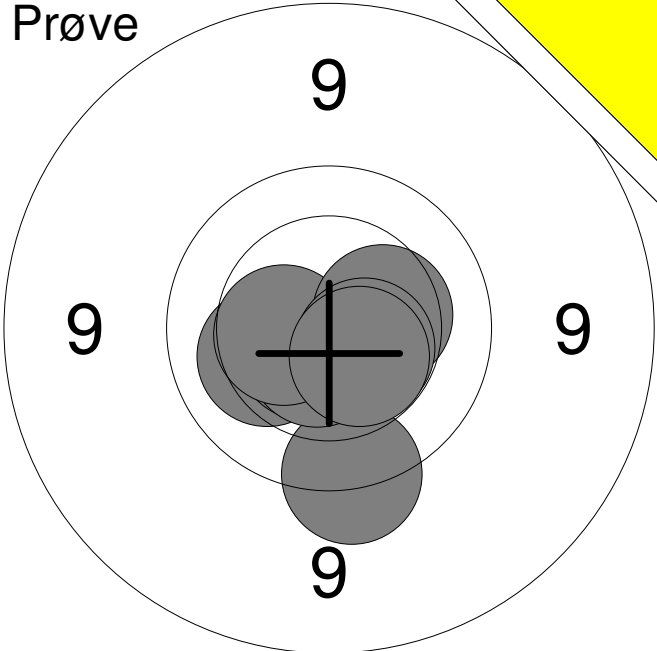
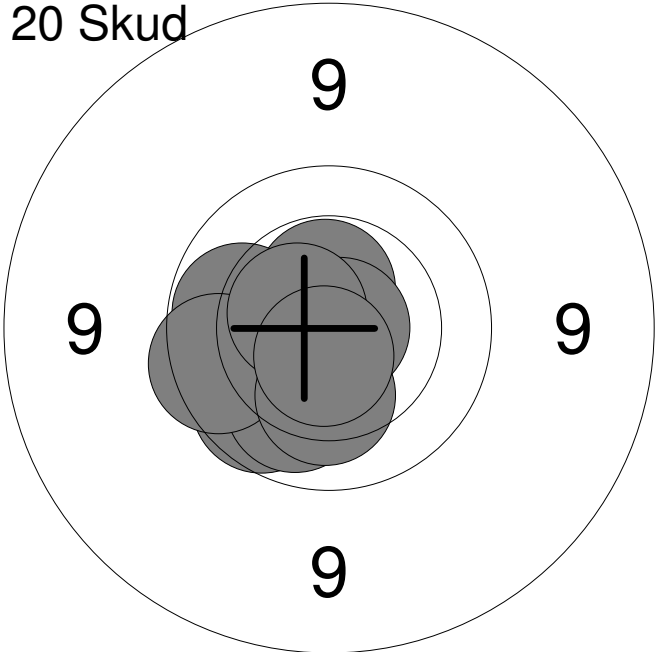
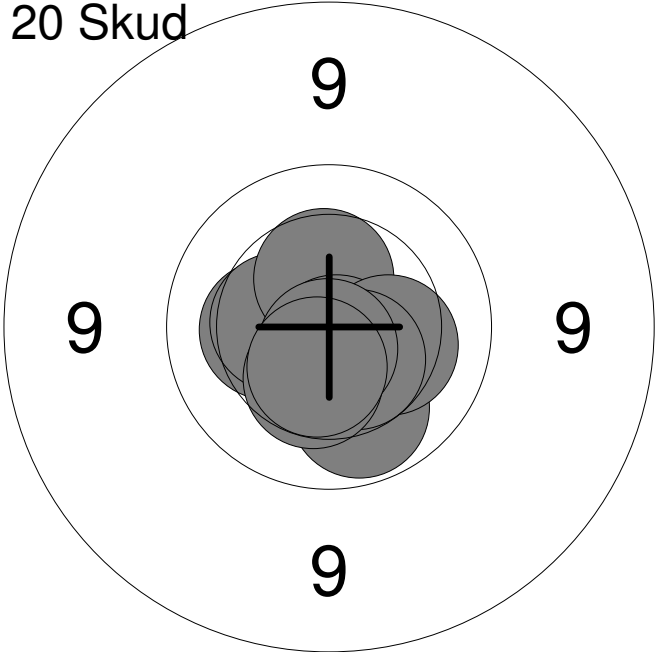
Hold	Skive	Thomas Grøn Bendixen			
12	11				
15m	Hjørring Skytteforening	BK1			
30.01.2015	Nordjysk mesterskab 2015	Aalborg Skyttekreds			
Prøve		1:	10.2	↙	
		2:	9.6	↓	
		3:	10.6x	↙	
		4:	10.6x	↓	
		5:	10.5	↙	
		6:	10.4	→	
		7:	10.5x	↘	
		8:	10.5x	↓	
		Serie		79.0	
		Total		0.0	
20 Skud		1:	9.9	↙	
		2:	10.1	↓	
		3:	10.5x	↑	
		4:	10.5	↙	
		5:	10.0	↙	
		6:	9.8	↙	
		7:	10.2	↓	
		8:	10.8x	→	
		9:	10.6x	↗	
		10:	10.6x	↓	
Serie		98.0			
Total		98.0			
20 Skud		11:	10.0	↓	
		12:	10.3	↙	
		13:	10.4	↙	
		14:	10.4	↑	
		15:	10.7x	↓	
		16:	10.3	→	
		17:	10.5x	↓	
		18:	10.7x	↓	
		19:	10.4	↓	
		20:	10.5x	↓	
Serie		100.0			
Total		198.0			

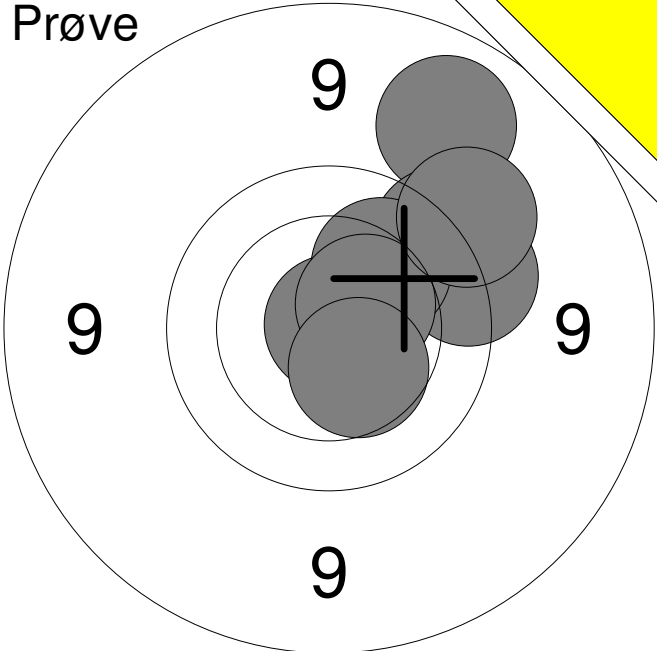
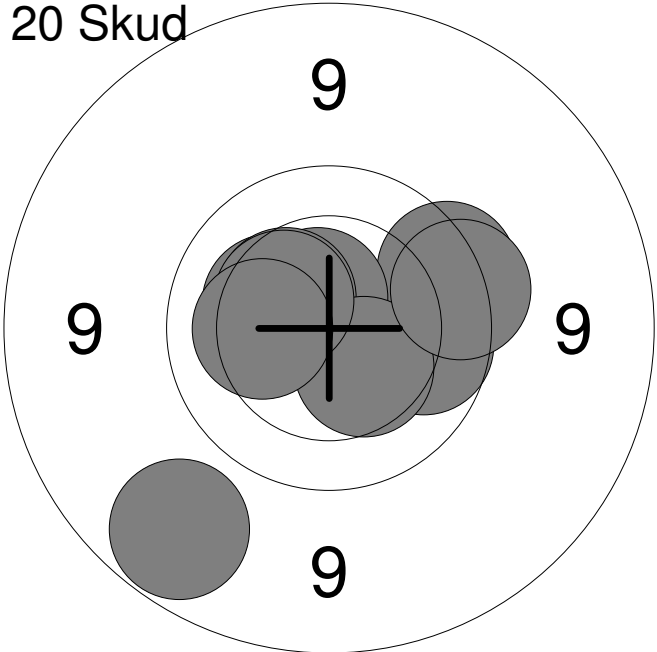
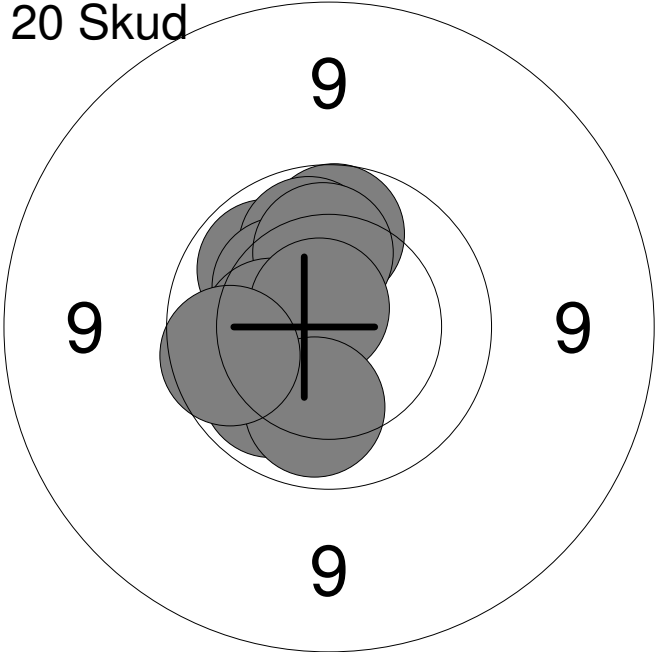
Hold	Skive	Mikkel Lyberth Nielsen	
12	12	Hjørring Skytteforening	BK4
15m			
30.01.2015	Nordjysk mesterskab 2015	Aalborg Skyttekreds	
Prøve		1: 9.1 ↗	
		2: 10.9x ↗	
		3: 9.6 ↗	
		4: 9.6 →	
		5: 10.1 ↗	
		6: 10.5 ↗	
		7: 9.4 ↗	
		8: 10.4 ↘	
		<b>Serie</b>	<b>76.0</b>
		<b>Total</b>	<b>0.0</b>
20 Skud		1: 9.9 →	
		2: 9.7 ↗	
		3: 10.6x ↗	
		4: 9.0 ↘	
		5: 10.3 ↗	
		6: 10.4 ↗	
		7: 10.4 ↘	
		8: 10.4 ↗	
		9: 10.2 ←	
		10: 9.7 →	
		<b>Serie</b>	<b>96.0</b>
		<b>Total</b>	<b>96.0</b>
20 Skud		11: 9.9 ↑	
		12: 10.0 ↗	
		13: 10.1 ↑	
		14: 10.1 ↘	
		15: 10.3 ↗	
		16: 10.1 ↑	
		17: 10.3 ←	
		18: 10.7x ↗	
		19: 10.1 ↘	
		20: 9.9 ←	
		<b>Serie</b>	<b>98.0</b>
		<b>Total</b>	<b>194.0</b>

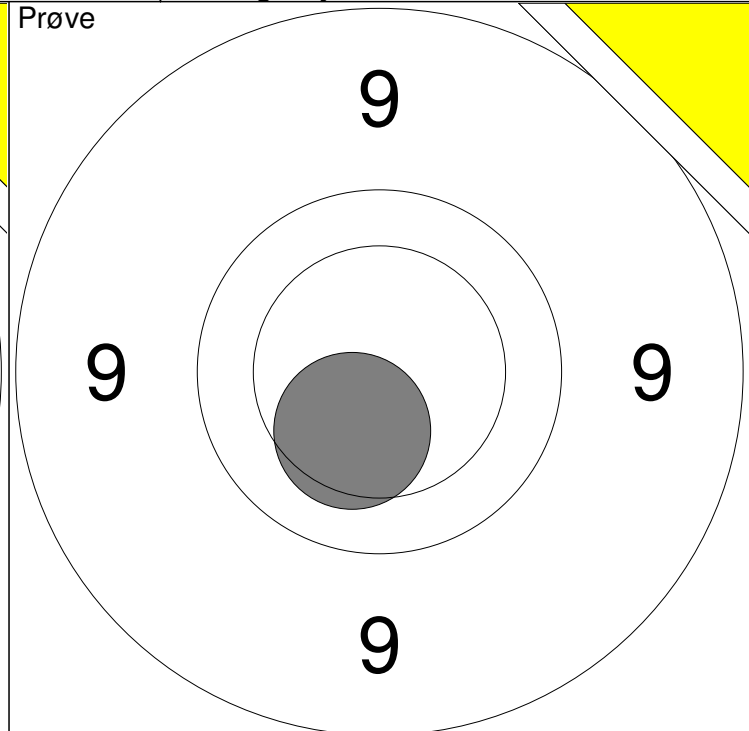
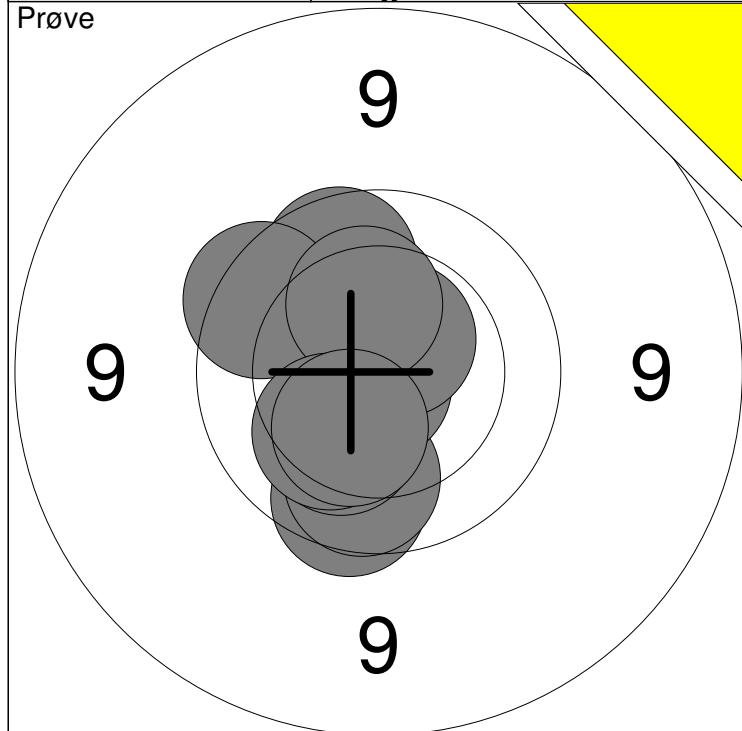

1: 9.9 ↗	6: 10.6x ↗	Serie	96
2: 9.8 ↓	7: 9.8 ↖		
3: 9.9 ↓	8: 10.3 ↗	Total	0
4: 10.2 ↓	9: 10.2 ↓		
5: 10.8x ↓	10: 10.3 ↓		

11: 10.3 ↓	Serie	10
	Total	0

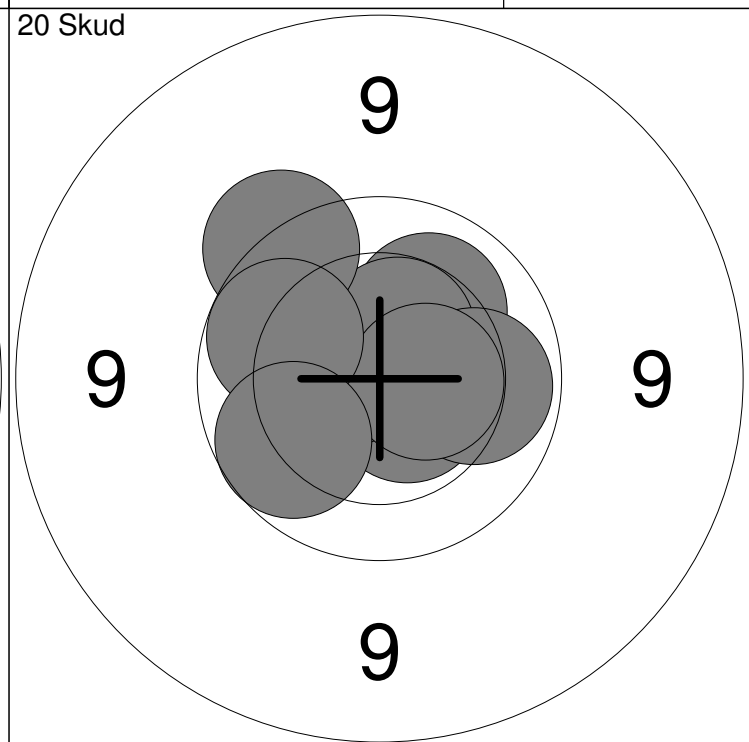
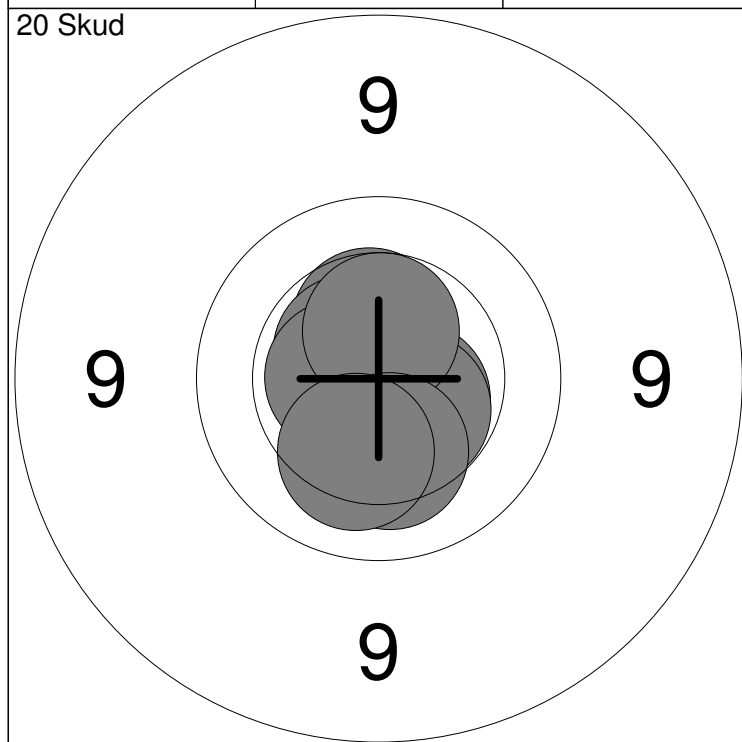

1: 10.8x ↓	6: 10.6x ↗	Serie	100
2: 10.6x ↓	7: 10.6x ←		
3: 10.4 ↗	8: 10.5x ↗	Total	100
4: 10.7x ↖	9: 10.2 ↓		
5: 10.5x ↓	10: 10.2 ↓		

11: 10.7x ↗	16: 10.0 →	Serie	98
12: 10.6x ↓	17: 9.6 ↗		
13: 10.6x ←	18: 10.5x →	Total	198
14: 10.1 ↗	19: 10.0 ↖		
15: 10.5x ↗	20: 9.9 ↖		

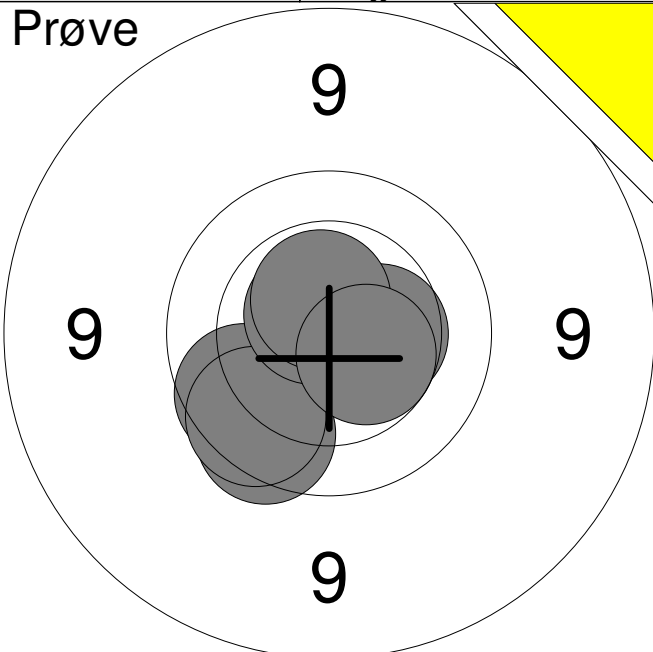
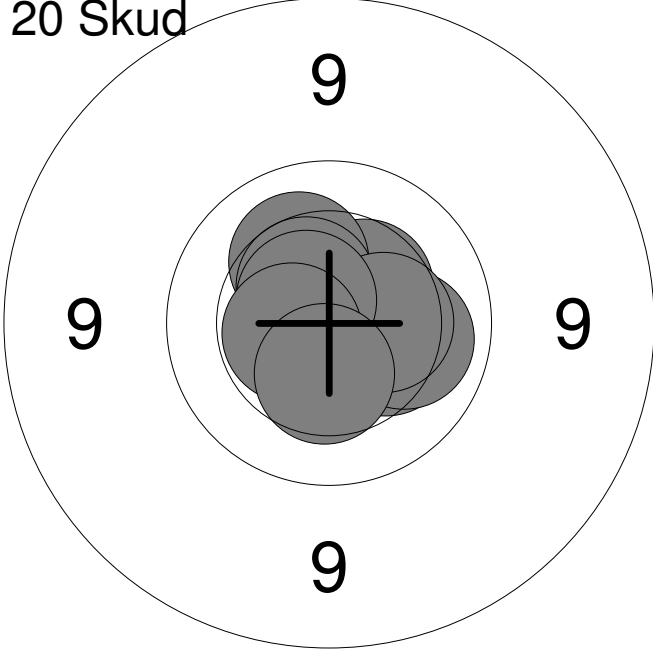
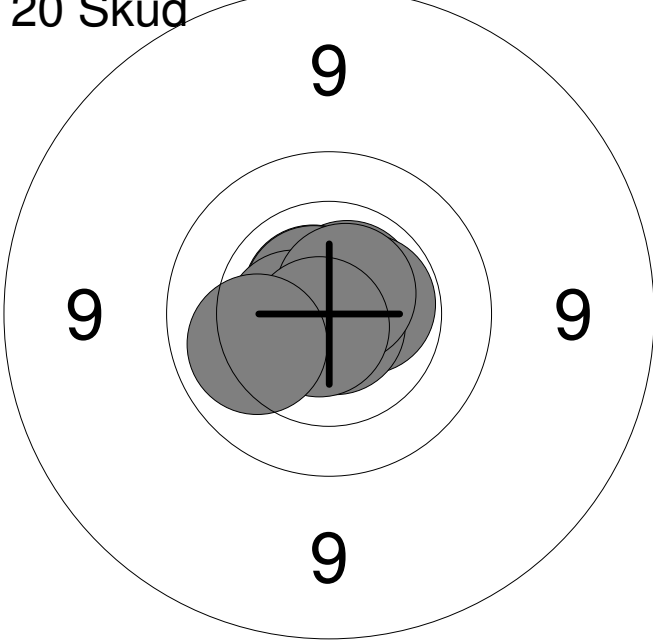

Hold <b>13</b>	Skive <b>2</b>	<b>Mads Lyng</b>	
15m	Vester Hassing Skf.	BK1	
30.01.2015	Nordjysk mesterskab 2015	Aalborg Skyttekreds	
Prøve		1: 9.9	↙
		2: 9.8	↙
		3: 9.8	↙
		4: 10.7x	↗
		5: 10.4	→
		6: 10.6x	↗
		7: 10.5	↘
		<b>Serie</b>	<b>67.0</b>
		<b>Total</b>	<b>0.0</b>
20 Skud		1: 10.5x	↓
		2: 10.3	→
		3: 10.4	↗
		4: 10.2	↗
		5: 10.1	→
		6: 10.5	↗
		7: 10.4	→
		8: 10.6x	↗
		9: 10.5x	↖
		10: 10.4	↓
		<b>Serie</b>	<b>100.0</b>
		<b>Total</b>	<b>100.0</b>
20 Skud		11: 10.9x	↗
		12: 10.6x	↗
		13: 10.5x	→
		14: 10.7x	↗
		15: 10.7x	↗
		16: 10.8x	↘
		17: 10.6x	↖
		18: 10.7x	↗
		19: 10.8x	↙
		20: 10.1	↖
		<b>Serie</b>	<b>100.0</b>
		<b>Total</b>	<b>200.0</b>

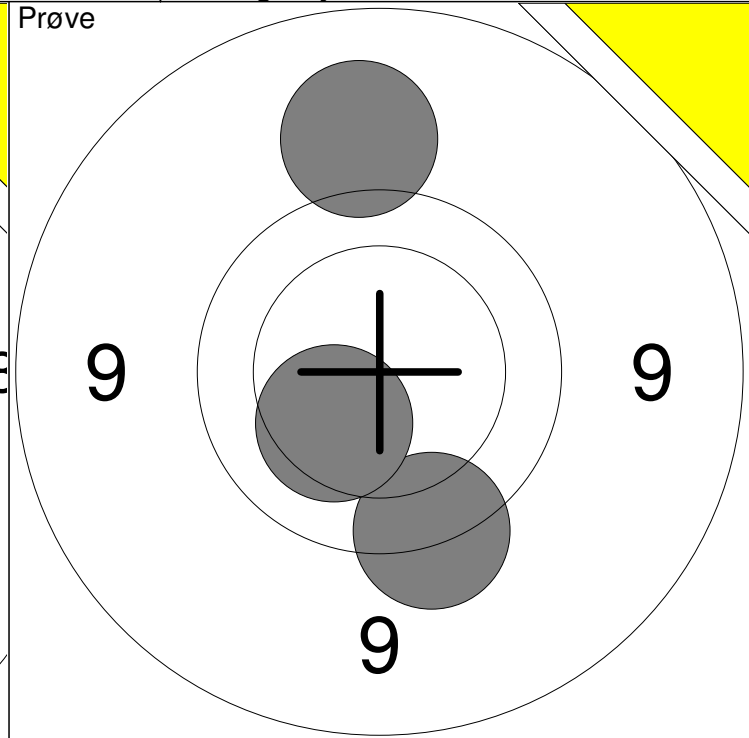
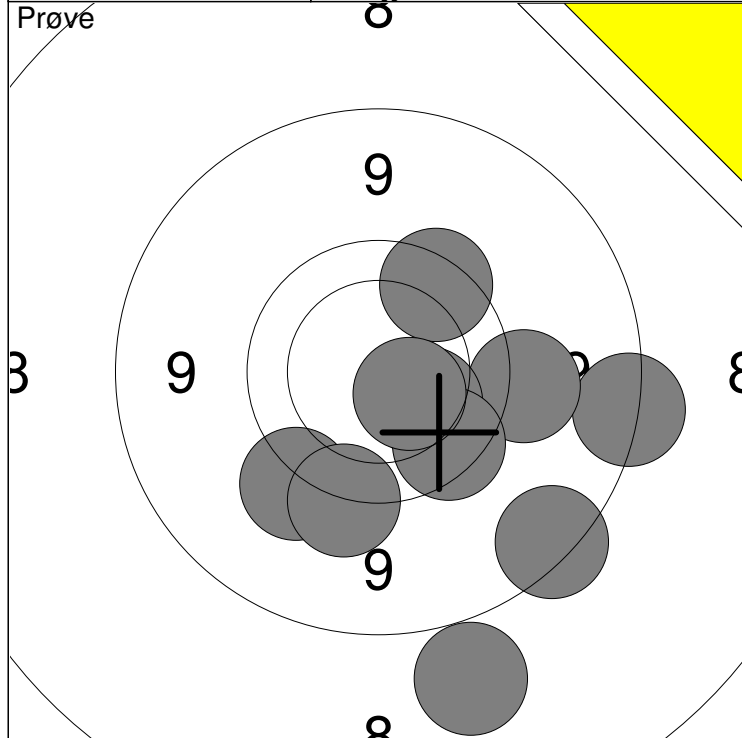

1: 8.8 ↘	6: 9.5 ↘	Serie	89
2: 9.5 ↘	7: 10.2 ↘		
3: 8.4 ↘	8: 9.8 ↘	Total	0
4: 8.7 →	9: 9.7 ↗		
5: 9.4 →	10: 10.4 ↘		

11: 9.6 ↘	Serie	28
12: 9.2 ↗		
13: 10.3 ↘	Total	0

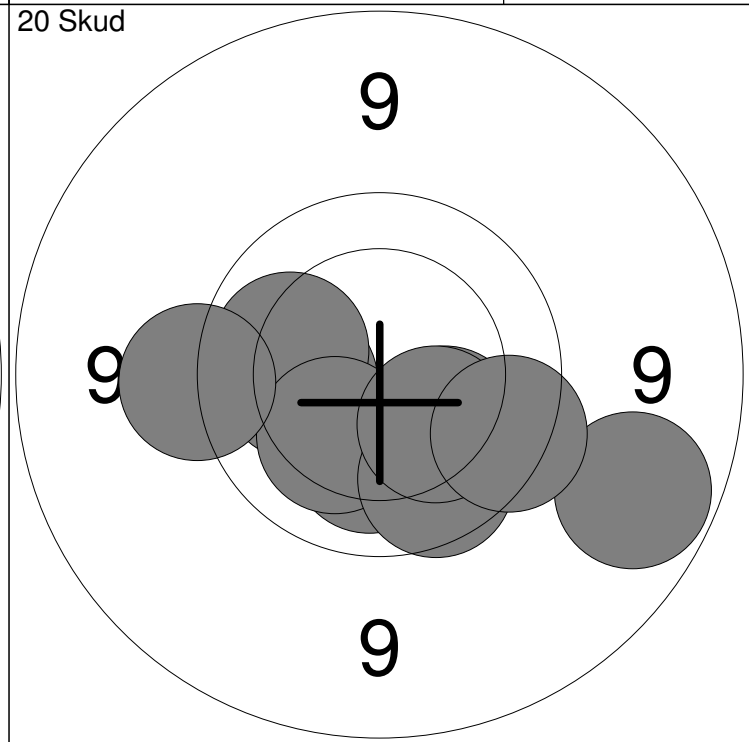
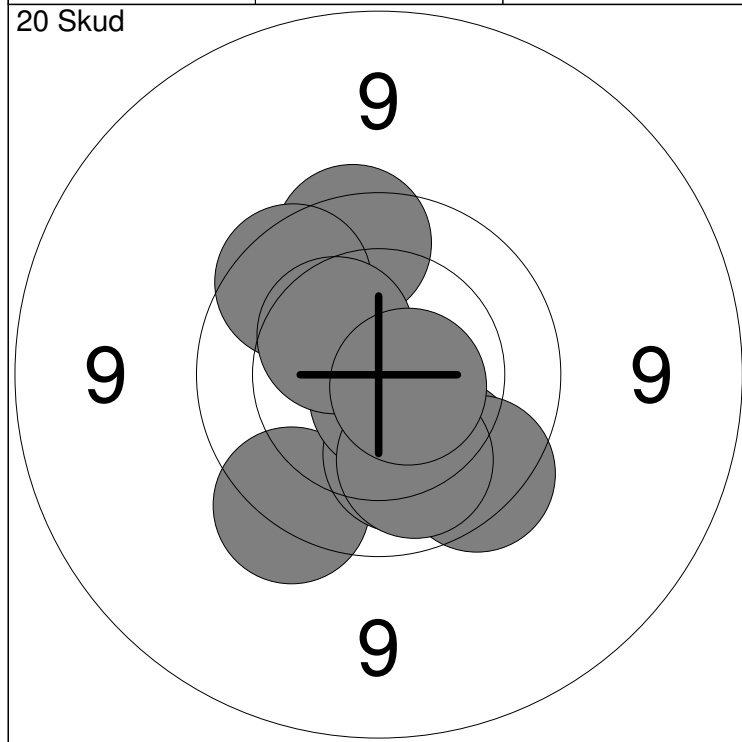

1: 10.0 ↘	6: 9.8 ↗	Serie	96
2: 9.7 ↘	7: 10.7x ↘		
3: 9.8 ↘	8: 10.1 ↘	Total	96
4: 10.2 ↘	9: 10.4 ↗		
5: 9.8 ↗	10: 10.6x ↘		

11: 10.2 ←	16: 9.5 ←	Serie	96
12: 10.1 ←	17: 10.2 ↘		
13: 9.0 →	18: 9.9 ↘	Total	192
14: 10.2 ↘	19: 10.2 ↘		
15: 10.2 ↘	20: 9.7 ↘		

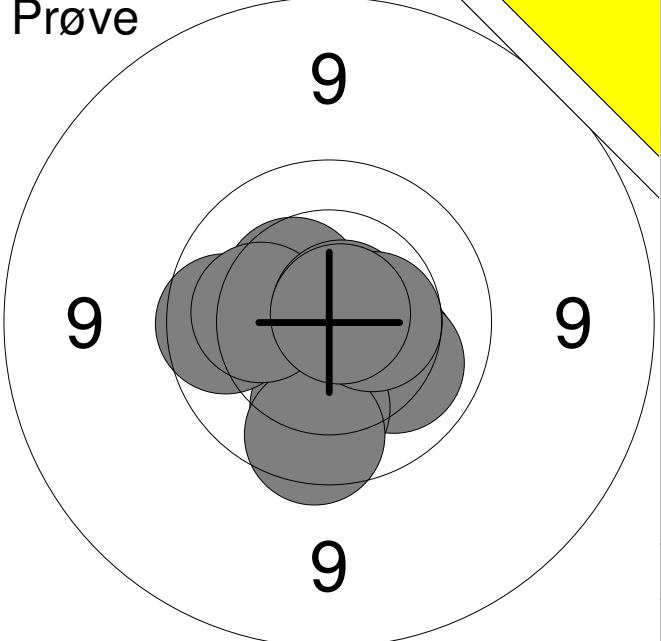
<b>Prøve</b> 	1:	10.2	↘
	2:	10.1	↘
	3:	10.0	↓
	4:	9.8	↓
	5:	10.4	↗
	6:	9.9	←
	7:	10.2	←
	8:	10.8x	↗
	9:	10.5	→
	10:	10.8x	↗
	<b>Serie</b>		
<b>Total</b>			<b>0.0</b>

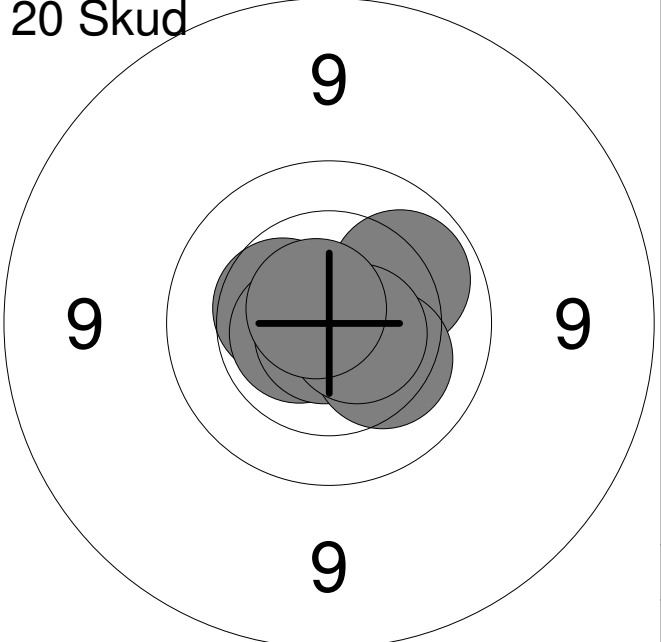
<b>20 Skud</b> 	1:	10.8x	←
	2:	10.1	↗
	3:	10.9x	←
	4:	10.4	←
	5:	10.9x	↑
	6:	10.6x	←
	7:	10.8x	↓
	8:	10.2	↘
	9:	10.6x	→
	10:	10.7x	↗
	<b>Serie</b>		
<b>Total</b>			<b>100.0</b>

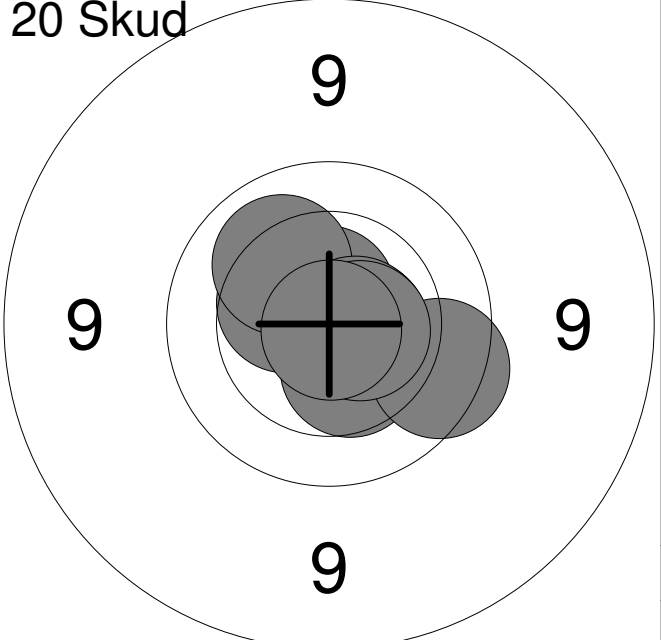
<b>20 Skud</b> 	11:	10.4	↘
	12:	10.7x	→
	13:	9.8	↘
	14:	10.6x	↑
	15:	10.4	↗
	16:	10.1	↗
	17:	10.6x	→
	18:	10.7x	→
	19:	10.6x	→
	20:	10.9x	↓
	<b>Serie</b>		
<b>Total</b>			<b>199.0</b>

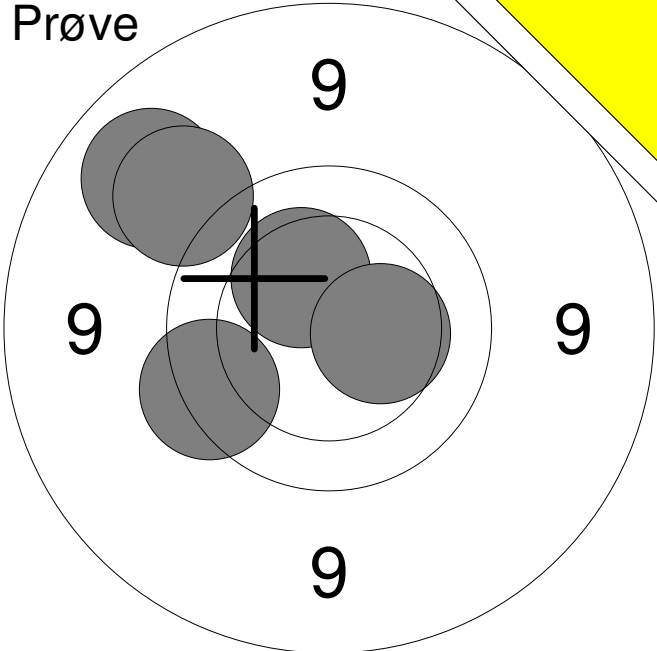
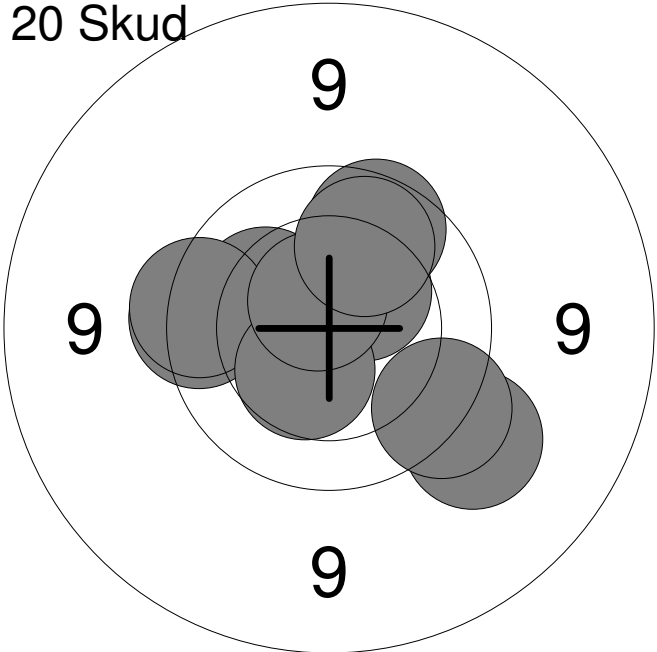
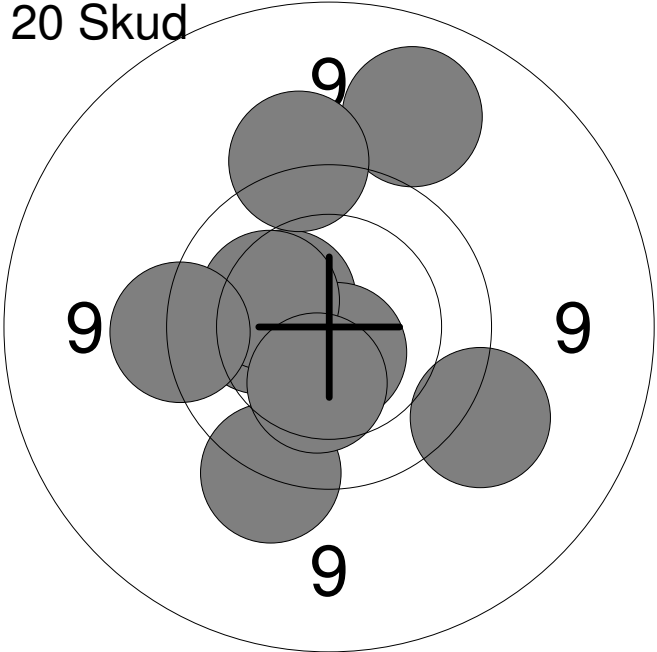
Hold	Skive	Cathrine Hansen	
13	6	Skf. Kimbrene	MJ2
15m			
30.01.2015	Nordjysk mesterskab 2015	Aalborg Skyttekreds	
Prøve		1: 9.1	↗
		2: 9.3	↗
		3: 10.3	↗
		4: 9.7	↖
		5: 10.4	→
	Serie	47.0	
	Total	0.0	
20 Skud		1: 9.7	←
		2: 10.4	↗
		3: 10.2	↗
		4: 9.7	←
		5: 10.4	↘
		6: 9.4	↘
		7: 9.8	↗
		8: 9.7	↘
		9: 10.6x	↗
		10: 10.0	↗
	Serie	95.0	
	Total	95.0	
20 Skud		11: 9.1	↗
		12: 10.4	↗
		13: 9.5	↗
		14: 10.2	←
		15: 9.6	↘
		16: 10.7x	↘
		17: 10.2	↗
		18: 9.6	←
		19: 10.3	↘
		20: 9.4	↘
	Serie	95.0	
	Total	190.0	

Hold <b>13</b>	Skive <b>7</b>	<b>Kasper Kajberg Christensen</b>	
-------------------	-------------------	-----------------------------------	--

15m	Løgstør Sportsskytteklub	MB4	
-----	--------------------------	-----	--

30.01.2015	Nordjysk mesterskab 2015	Aalborg Skyttekreds	
------------	--------------------------	---------------------	--

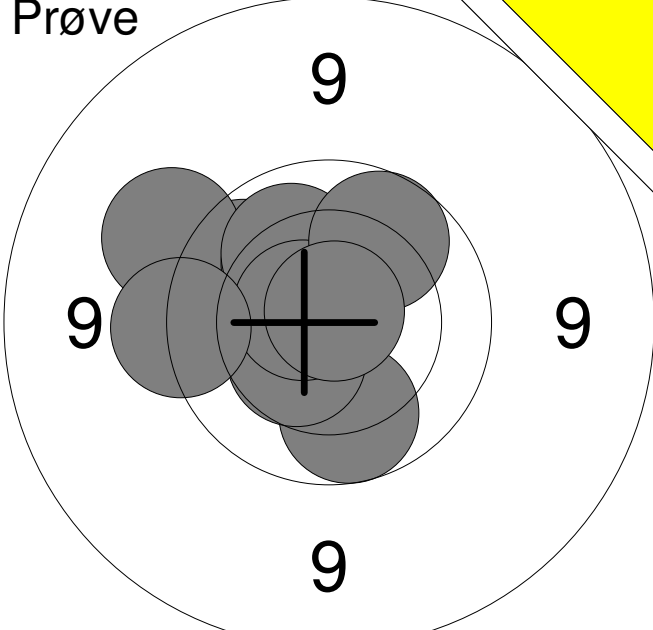
<b>Prøve</b> 	1:	9.9	↗
	2:	9.4	↗
	3:	10.2	↗
	4:	10.1	↗
	5:	10.0	↘
	6:	10.4	↖
	7:	10.6x	↗
	8:	9.6	↖
	9:	9.9	↗
	10:	10.8x	↗
	<b>Serie</b>		<b>96.0</b>
<b>Total</b>		<b>0.0</b>	

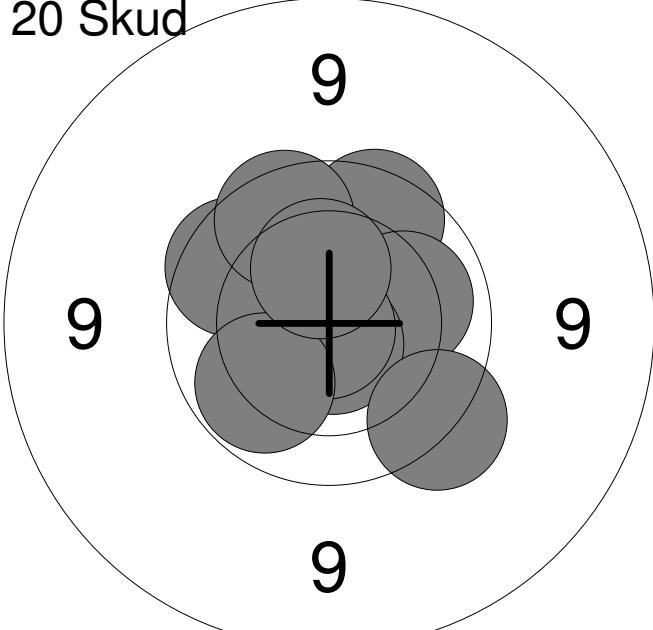
<b>20 Skud</b> 	1:	9.9	↗
	2:	9.8	↗
	3:	10.1	→
	4:	10.7x	↘
	5:	10.9x	↘
	6:	9.6	↘
	7:	9.8	↗
	8:	9.8	↗
	9:	10.0	↖
	10:	10.4	↗
	<b>Serie</b>		<b>95.0</b>
<b>Total</b>		<b>95.0</b>	

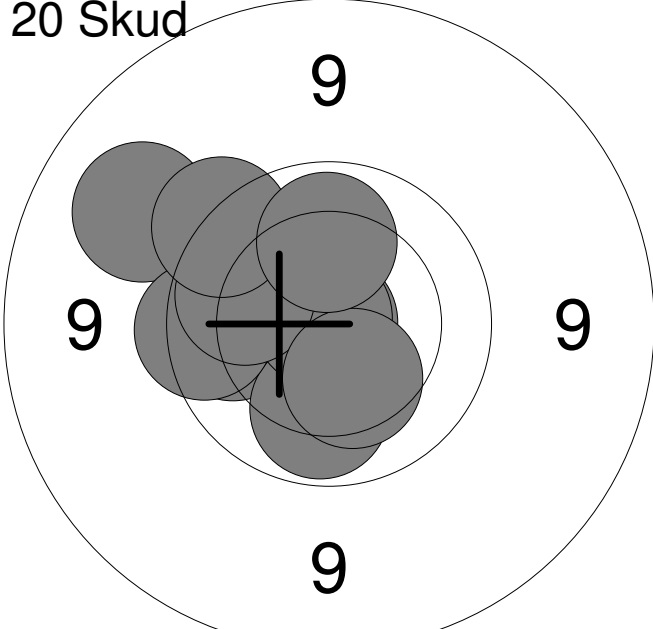
<b>20 Skud</b> 	11:	9.9	↖
	12:	10.9x	↗
	13:	10.0	↘
	14:	9.2	↗
	15:	10.8x	↗
	16:	9.7	↖
	17:	10.0	↗
	18:	9.6	↗
	19:	10.3	↘
	20:	10.1	↗
	<b>Serie</b>		<b>96.0</b>
<b>Total</b>		<b>191.0</b>	

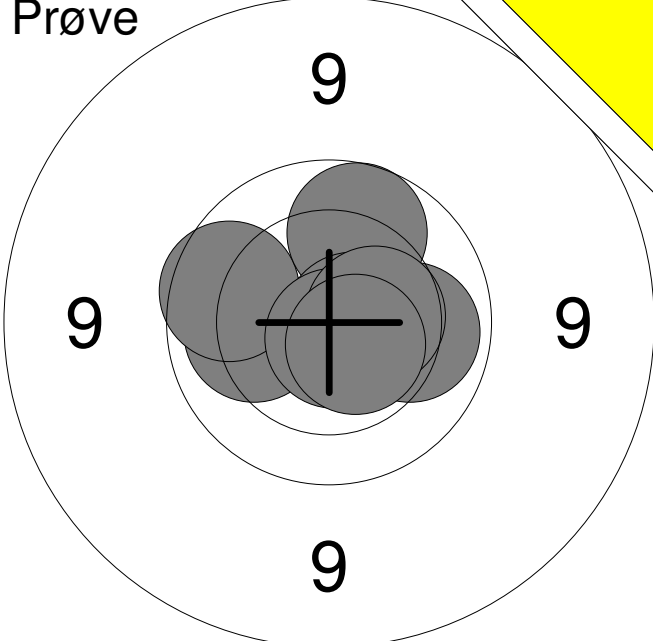
<b>Prøve</b> 	1: 10.1	→
	2: 10.1	←
	3: 9.9	←
	4: 9.9	↑
	5: 10.7x	→
	6: 10.8x	↓
	7: 10.4	→
	8: 10.6x	↓
	<b>Serie</b>	<b>78.0</b>
	<b>Total</b>	<b>0.0</b>

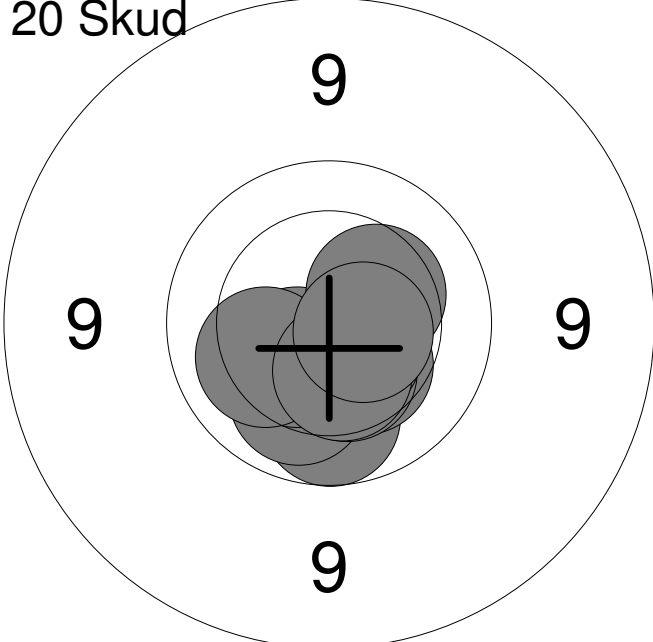
<b>20 Skud</b> 	1: 9.9	↓
	2: 10.4	↓
	3: 10.1	↓
	4: 10.4	↓
	5: 10.6x	↓
	6: 10.4	↙
	7: 10.2	←
	8: 10.4	↓
	9: 10.4	↗
	10: 10.6x	→
	<b>Serie</b>	<b>99.0</b>
<b>Total</b>	<b>99.0</b>	

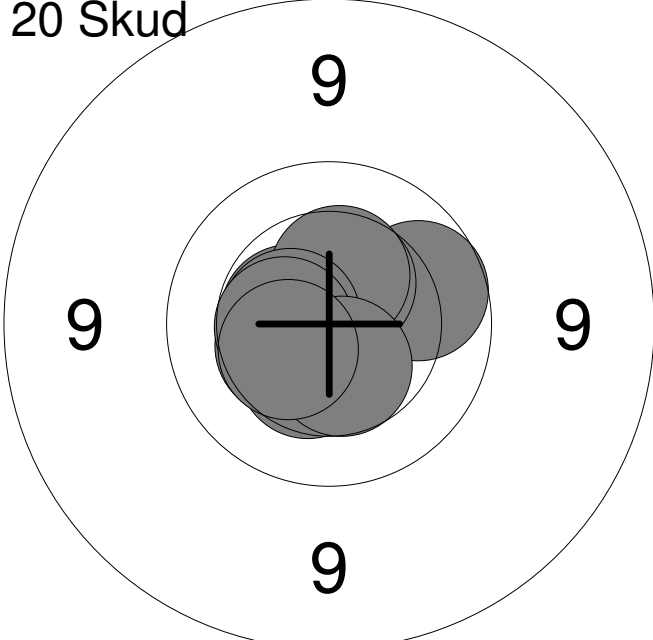
<b>20 Skud</b> 	11: 10.4	←
	12: 9.9	→
	13: 10.5	↑
	14: 10.5x	←
	15: 10.4	↑
	16: 10.5x	←
	17: 10.4	↓
	18: 10.5	←
	19: 10.5	↓
	20: 10.4	↙
	<b>Serie</b>	<b>99.0</b>
<b>Total</b>	<b>198.0</b>	

Hold <b>13</b>	Skive <b>9</b>	<b>Mie Marie Lassen</b>	
-------------------	-------------------	-------------------------	--

15m	Års Skf.	MB3
-----	----------	-----

30.01.2015	Nordjysk mesterskab 2015	Aalborg Skyttekreds
------------	--------------------------	---------------------

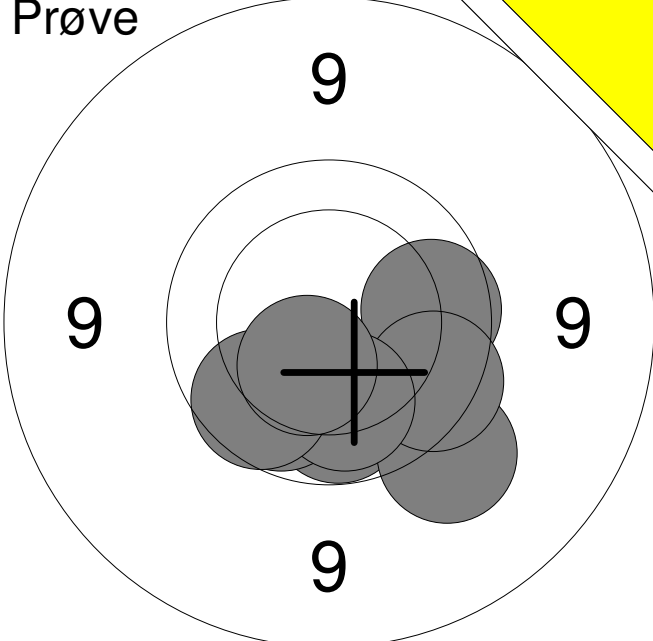
<b>Prøve</b> 	1:	9.9	→
	2:	10.0	↓
	3:	10.0	↙
	4:	9.4	↘
	5:	9.8	↘
	6:	10.1	↓
	7:	9.9	↙
	8:	10.4	↘
	<b>Serie</b>		<b>76.0</b>
<b>Total</b>		<b>0.0</b>	

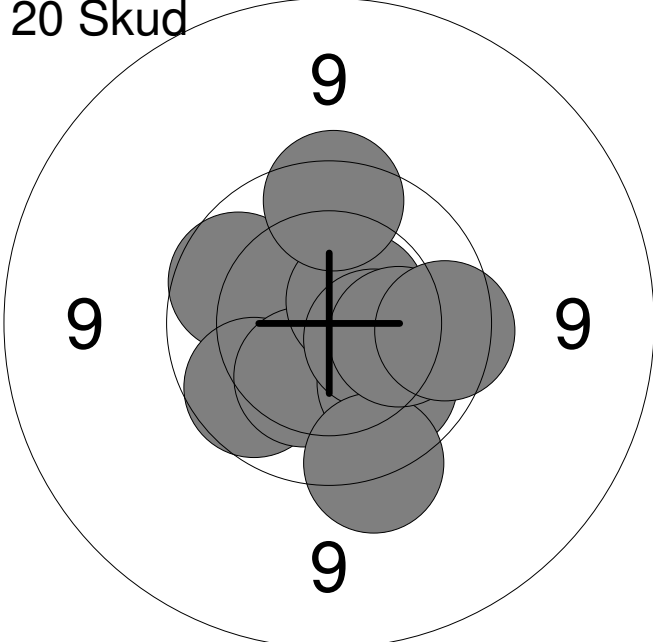
<b>20 Skud</b> 	1:	9.9	↖
	2:	9.9	↙
	3:	10.3	↓
	4:	10.0	↘
	5:	10.6x	→
	6:	10.4	→
	7:	9.6	↓
	8:	9.8	↑
	9:	10.2	→
	10:	9.8	→
<b>Serie</b>		<b>95.0</b>	
<b>Total</b>		<b>95.0</b>	

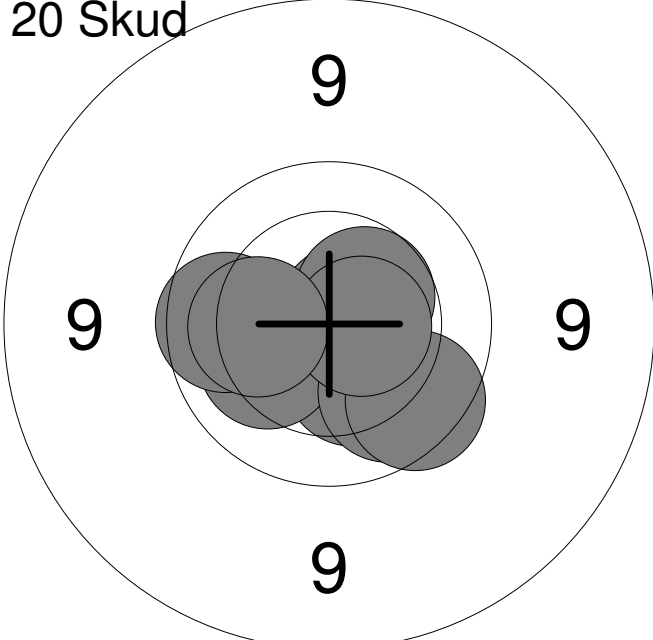
<b>20 Skud</b> 	11:	10.7x	→
	12:	10.5	→
	13:	10.6x	↘
	14:	10.3	↓
	15:	10.2	↙
	16:	10.0	↓
	17:	9.8	↘
	18:	9.9	←
	19:	10.6x	→
	20:	10.2	←
<b>Serie</b>		<b>98.0</b>	
<b>Total</b>		<b>193.0</b>	

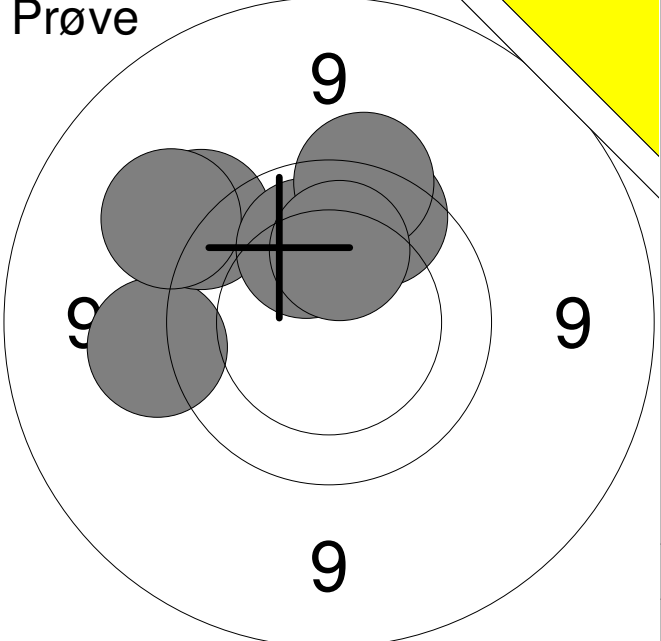
<p><b>Prøve</b></p> 	<table style="width:100%; border-collapse: collapse;"> <tr><td style="width:10%;">1:</td><td style="width:30%;">9.5</td><td style="width:10%; text-align: center;">←</td></tr> <tr><td>2:</td><td>9.5</td><td style="text-align: center;">↗</td></tr> <tr><td>3:</td><td>9.4</td><td style="text-align: center;">↗</td></tr> <tr><td>4:</td><td>10.1</td><td style="text-align: center;">↑</td></tr> <tr><td>5:</td><td>9.8</td><td style="text-align: center;">↗</td></tr> <tr><td>6:</td><td>9.6</td><td style="text-align: center;">↑</td></tr> <tr><td>7:</td><td>10.2</td><td style="text-align: center;">↑</td></tr> </table>	1:	9.5	←	2:	9.5	↗	3:	9.4	↗	4:	10.1	↑	5:	9.8	↗	6:	9.6	↑	7:	10.2	↑
1:	9.5	←																				
2:	9.5	↗																				
3:	9.4	↗																				
4:	10.1	↑																				
5:	9.8	↗																				
6:	9.6	↑																				
7:	10.2	↑																				
<table style="width:100%; border-collapse: collapse;"> <tr> <td style="width:10%;"><b>Serie</b></td> <td style="width:80%;"></td> <td style="width:10%; text-align: right;"><b>65.0</b></td> </tr> <tr> <td><b>Total</b></td> <td></td> <td style="text-align: right;"><b>0.0</b></td> </tr> </table>		<b>Serie</b>		<b>65.0</b>	<b>Total</b>		<b>0.0</b>															
<b>Serie</b>		<b>65.0</b>																				
<b>Total</b>		<b>0.0</b>																				

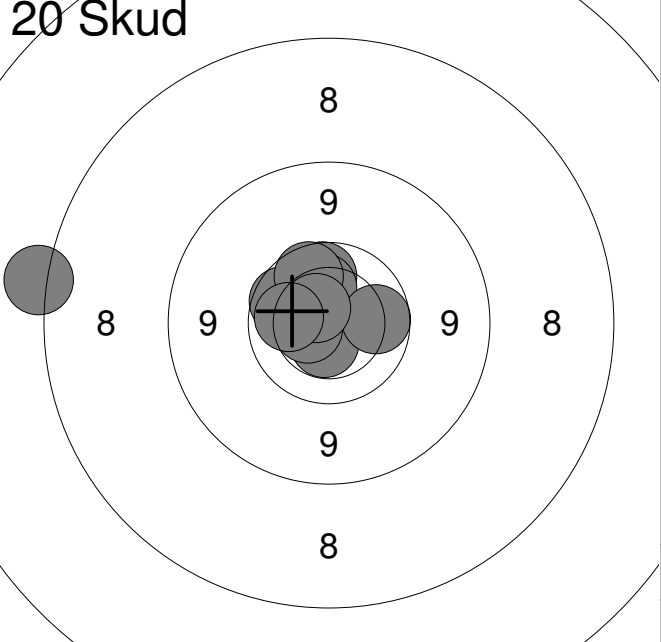
<p><b>20 Skud</b></p> 	<table style="width:100%; border-collapse: collapse;"> <tr><td style="width:10%;">1:</td><td style="width:30%;">10.5x</td><td style="width:10%; text-align: center;">↓</td></tr> <tr><td>2:</td><td>9.9</td><td style="text-align: center;">↑</td></tr> <tr><td>3:</td><td>10.2</td><td style="text-align: center;">↑</td></tr> <tr><td>4:</td><td>9.9</td><td style="text-align: center;">→</td></tr> <tr><td>5:</td><td>10.5</td><td style="text-align: center;">←</td></tr> <tr><td>6:</td><td>9.9</td><td style="text-align: center;">↗</td></tr> <tr><td>7:</td><td>9.9</td><td style="text-align: center;">↑</td></tr> <tr><td>8:</td><td>10.5x</td><td style="text-align: center;">↗</td></tr> <tr><td>9:</td><td>10.1</td><td style="text-align: center;">←</td></tr> <tr><td>10:</td><td>7.6</td><td style="text-align: center;">←</td></tr> </table>	1:	10.5x	↓	2:	9.9	↑	3:	10.2	↑	4:	9.9	→	5:	10.5	←	6:	9.9	↗	7:	9.9	↑	8:	10.5x	↗	9:	10.1	←	10:	7.6	←
1:	10.5x	↓																													
2:	9.9	↑																													
3:	10.2	↑																													
4:	9.9	→																													
5:	10.5	←																													
6:	9.9	↗																													
7:	9.9	↑																													
8:	10.5x	↗																													
9:	10.1	←																													
10:	7.6	←																													
<table style="width:100%; border-collapse: collapse;"> <tr> <td style="width:10%;"><b>Serie</b></td> <td style="width:80%;"></td> <td style="width:10%; text-align: right;"><b>93.0</b></td> </tr> <tr> <td><b>Total</b></td> <td></td> <td style="text-align: right;"><b>93.0</b></td> </tr> </table>		<b>Serie</b>		<b>93.0</b>	<b>Total</b>		<b>93.0</b>																								
<b>Serie</b>		<b>93.0</b>																													
<b>Total</b>		<b>93.0</b>																													

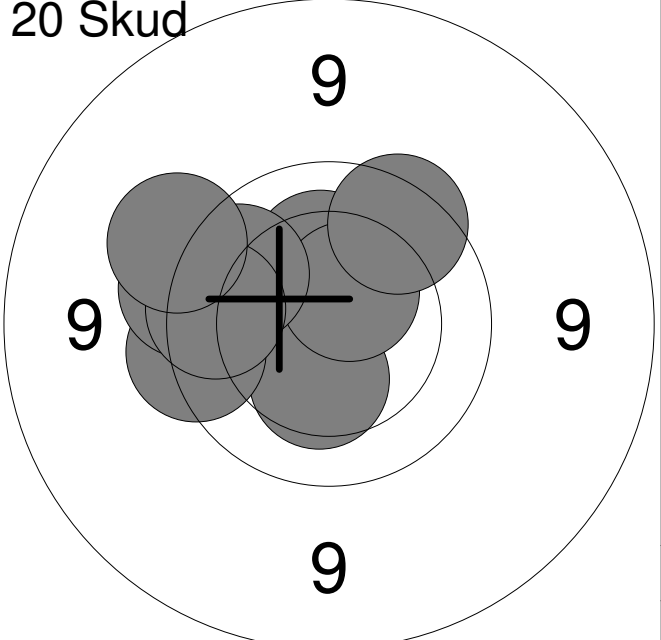
<p><b>20 Skud</b></p> 	<table style="width:100%; border-collapse: collapse;"> <tr><td style="width:10%;">11:</td><td style="width:30%;">10.3</td><td style="width:10%; text-align: center;">↑</td></tr> <tr><td>12:</td><td>10.3</td><td style="text-align: center;">↓</td></tr> <tr><td>13:</td><td>10.3</td><td style="text-align: center;">↑</td></tr> <tr><td>14:</td><td>9.7</td><td style="text-align: center;">←</td></tr> <tr><td>15:</td><td>10.5x</td><td style="text-align: center;">↗</td></tr> <tr><td>16:</td><td>9.9</td><td style="text-align: center;">↗</td></tr> <tr><td>17:</td><td>9.6</td><td style="text-align: center;">←</td></tr> <tr><td>18:</td><td>9.8</td><td style="text-align: center;">←</td></tr> <tr><td>19:</td><td>9.5</td><td style="text-align: center;">↗</td></tr> <tr><td>20:</td><td>9.8</td><td style="text-align: center;">↗</td></tr> </table>	11:	10.3	↑	12:	10.3	↓	13:	10.3	↑	14:	9.7	←	15:	10.5x	↗	16:	9.9	↗	17:	9.6	←	18:	9.8	←	19:	9.5	↗	20:	9.8	↗
11:	10.3	↑																													
12:	10.3	↓																													
13:	10.3	↑																													
14:	9.7	←																													
15:	10.5x	↗																													
16:	9.9	↗																													
17:	9.6	←																													
18:	9.8	←																													
19:	9.5	↗																													
20:	9.8	↗																													
<table style="width:100%; border-collapse: collapse;"> <tr> <td style="width:10%;"><b>Serie</b></td> <td style="width:80%;"></td> <td style="width:10%; text-align: right;"><b>94.0</b></td> </tr> <tr> <td><b>Total</b></td> <td></td> <td style="text-align: right;"><b>187.0</b></td> </tr> </table>		<b>Serie</b>		<b>94.0</b>	<b>Total</b>		<b>187.0</b>																								
<b>Serie</b>		<b>94.0</b>																													
<b>Total</b>		<b>187.0</b>																													

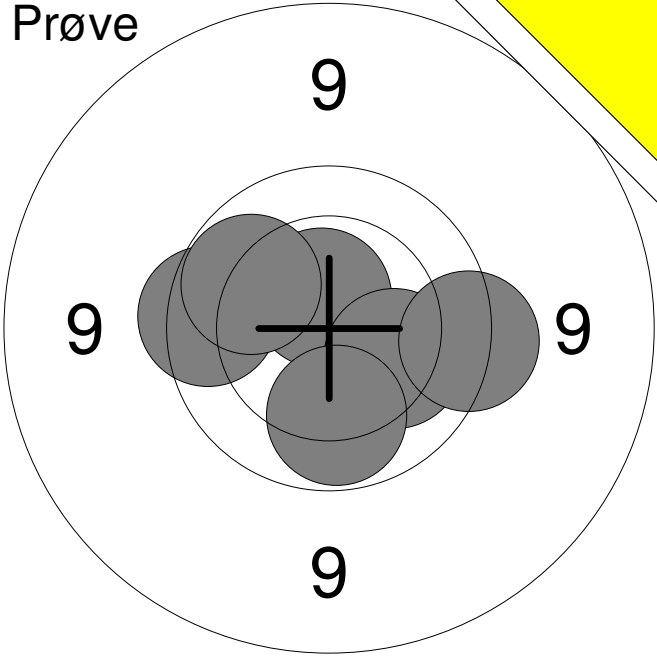
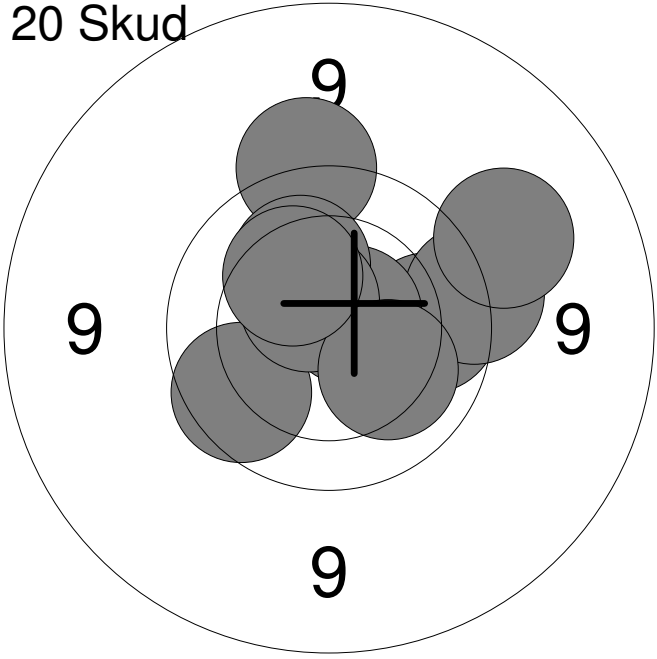
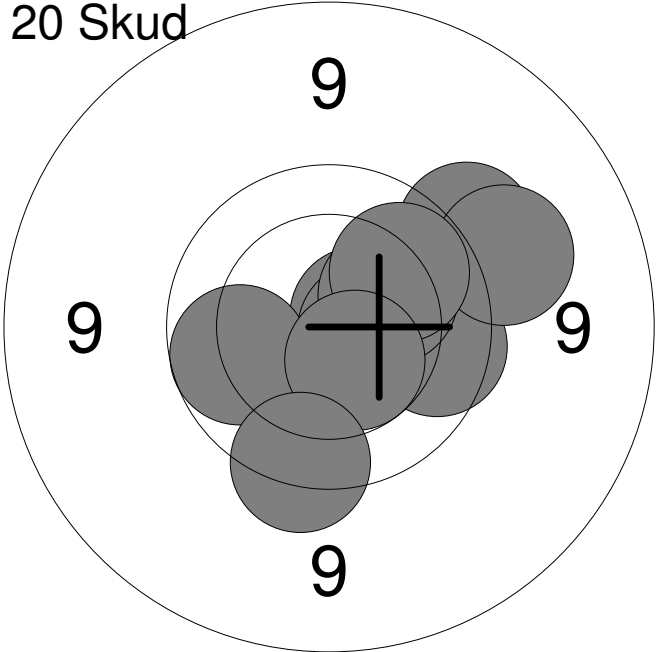

Hold	Skive	Christian Gadensgaard	
13	11	15m	Sæby og Omegns Skytteforening MB3
30.01.2015	Nordjysk mesterskab 2015	Aalborg Skyttekreds	
Prøve		1: 9.8 ←	
		2: 10.6x ↑	
		3: 10.2 ↘	
		4: 10.0 ↗	
		5: 10.0 ↓	
		6: 9.7 →	
Serie		58.0	
Total		0.0	
20 Skud		1: 9.9 →	
		2: 9.6 →	
		3: 10.7x ↗	
		4: 9.3 ↗	
		5: 9.8 ↖	
		6: 9.5 ↑	
		7: 10.2 ↑	
		8: 10.6x ↗	
		9: 10.2 ↘	
		10: 10.3 ↗	
Serie		95.0	
Total		95.0	
20 Skud		11: 10.6x →	
		12: 10.5x →	
		13: 9.8 →	
		14: 9.9 ←	
		15: 9.5 ↗	
		16: 9.4 →	
		17: 10.2 ↗	
		18: 10.0 ↗	
		19: 10.5x ↘	
		20: 9.7 ↓	
Serie		95.0	
Total		190.0	

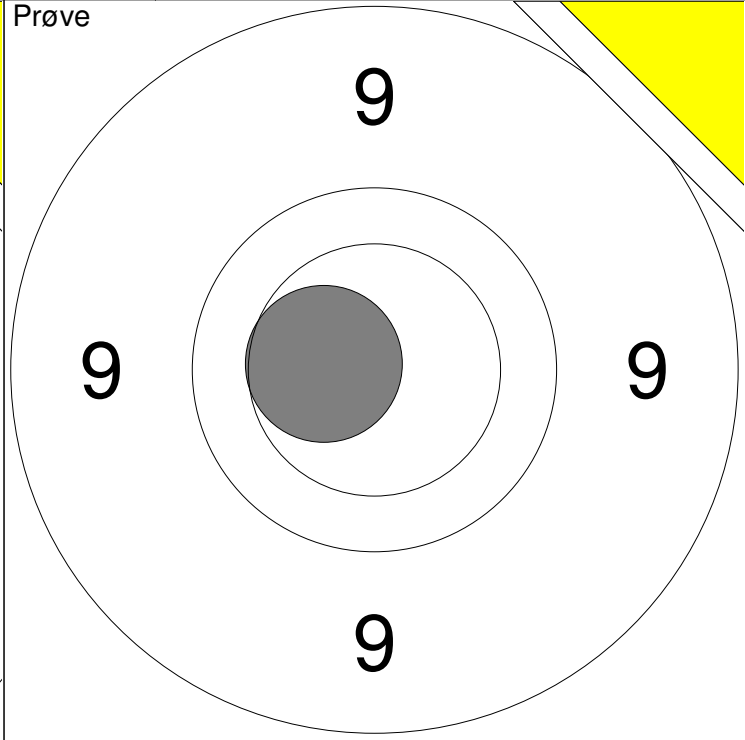
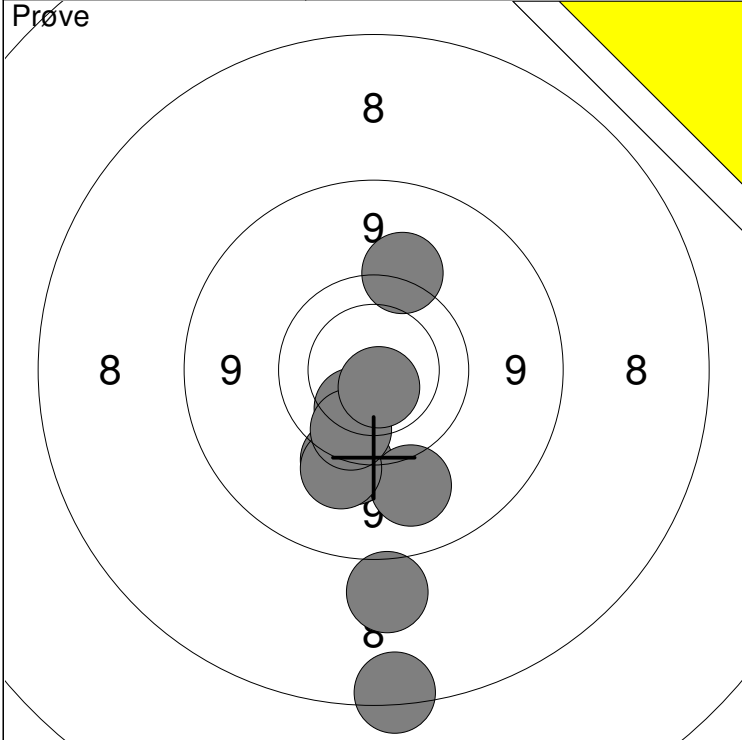

1: 7.8 ↓	6: 9.2 ↓	Serie	89
2: 8.4 ↓	7: 9.4 ↓		
3: 9.5 ↓	8: 9.8 ↓	Total	0
4: 10.2 ↓	9: 9.5 ↑		
5: 9.5 ↓	10: 10.6x ↓		

11: 10.5 ←	Serie	10
	Total	0

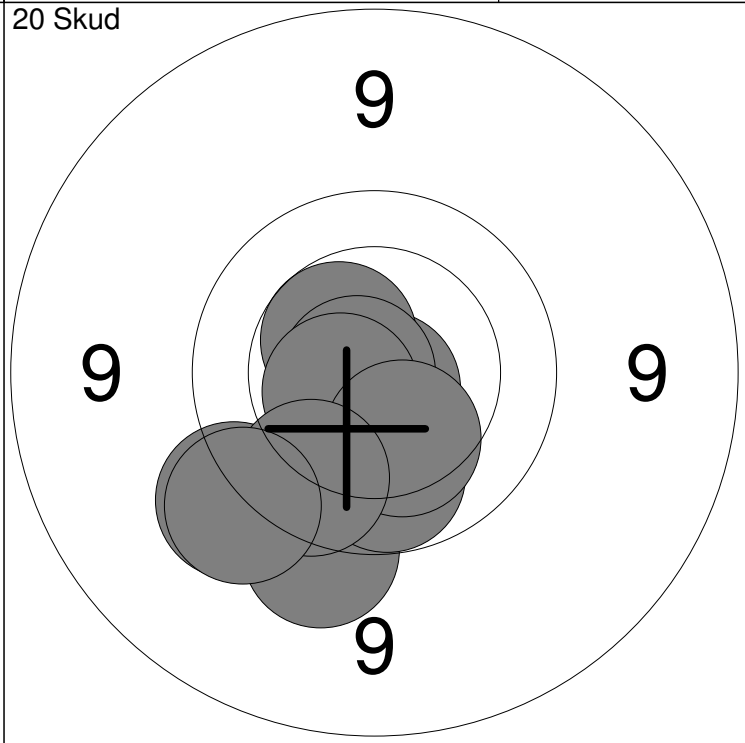
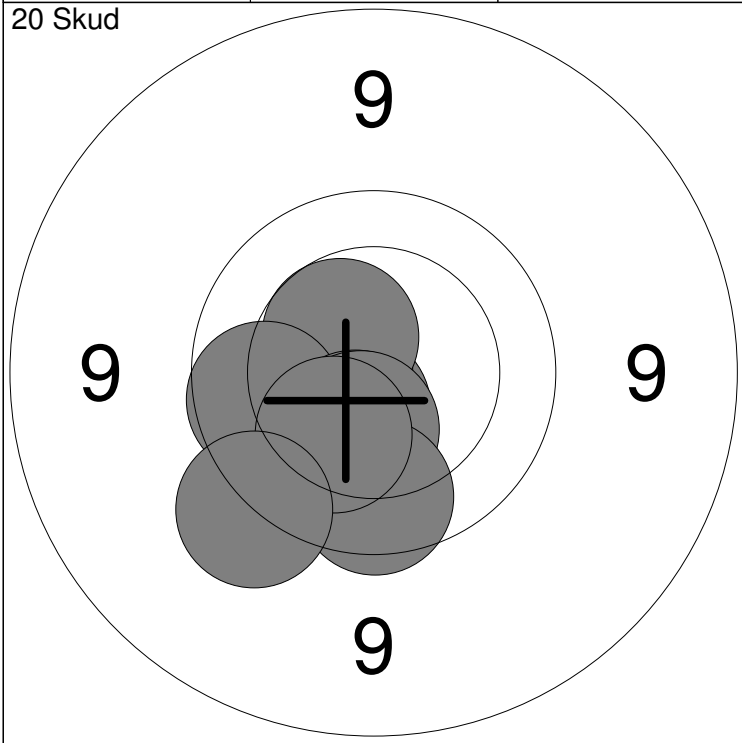

1: 10.5x ↓	6: 10.4 ↓	Serie	97
2: 10.4 ↓	7: 10.4 ↓		
3: 10.6x ←	8: 9.8 ↓	Total	97
4: 10.5 ↗	9: 10.2 ↓		
5: 9.9 ←	10: 9.5 ↓		

11: 9.5 ↓	16: 10.8x ←	Serie	96
12: 9.5 ↙	17: 10.6x ↙		
13: 10.0 ↓	18: 10.3 ↓	Total	193
14: 10.8x ↓	19: 9.8 ↓		
15: 10.5 ↗	20: 9.5 ↓		

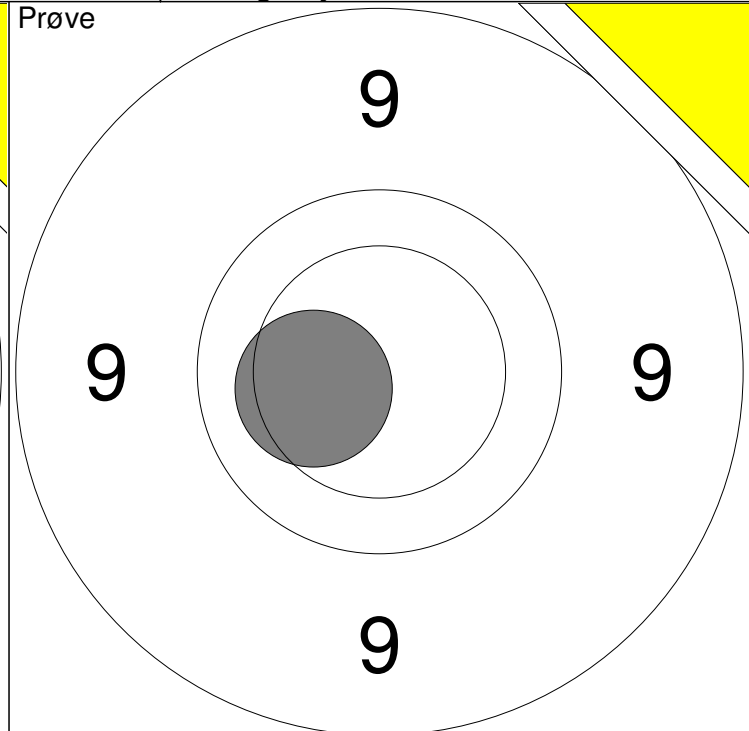
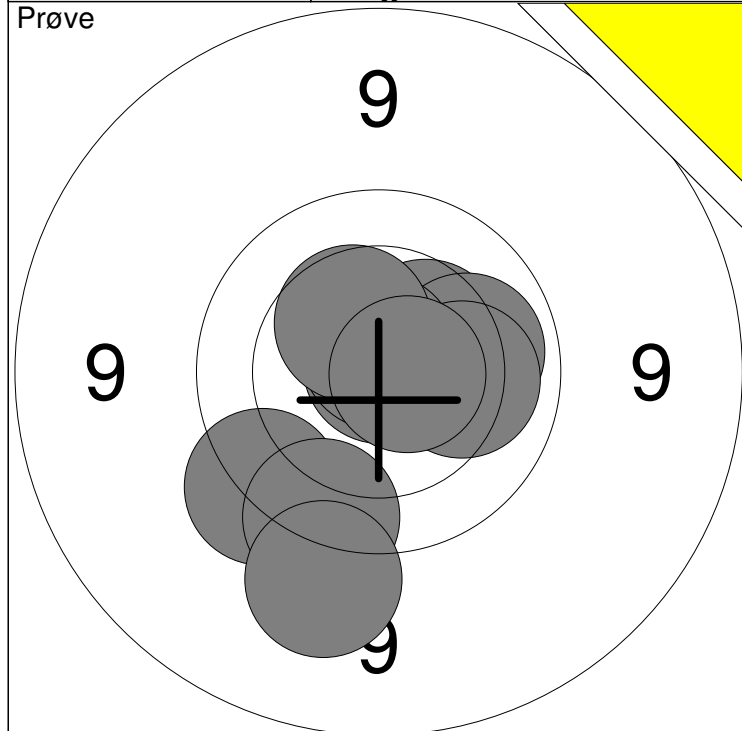

1: 9.6 ↙	6: 10.1 →	Serie	97
2: 9.7 ↓	7: 10.8x ↑		
3: 9.3 ↓	8: 10.1 →	Total	0
4: 10.9x ↑	9: 10.4 ↖		
5: 10.4 ↗	10: 10.7x →		

11: 10.3 ←	Serie	10
	Total	0

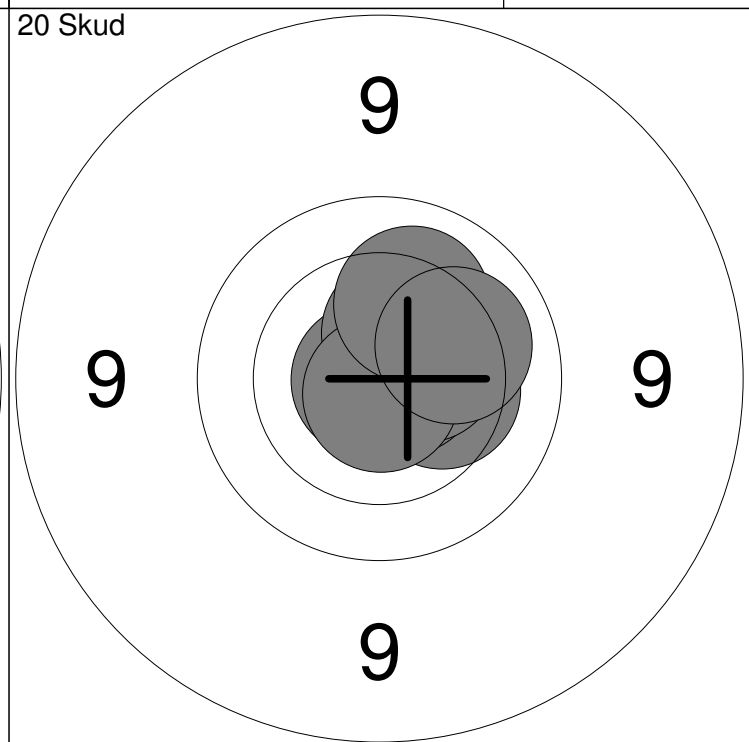
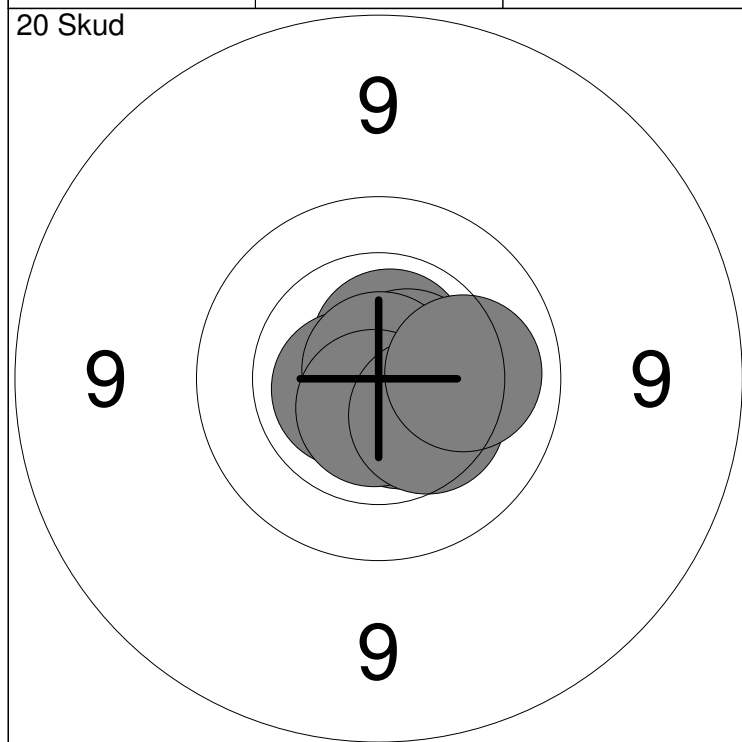

1: 10.6x ↓	6: 10.6x →	Serie	100
2: 10.6x ↑	7: 10.9x ↑		
3: 10.7x ←	8: 10.7x ↓	Total	100
4: 10.6x ↓	9: 10.4 ↘		
5: 10.6x ↘	10: 10.1 →		

11: 10.3 ↗	16: 10.7x →	Serie	100
12: 10.9x ←	17: 10.5x →		
13: 10.7x →	18: 10.8x ↓	Total	200
14: 10.3 →	19: 10.2 ↑		
15: 10.5 ↑	20: 10.2 →		

Hold <b>14</b>	Skive <b>2</b>	<b>Silja Francoise Nielsen</b>	
-------------------	-------------------	--------------------------------	--

15m	Vester Hassing Skf.	BK1
-----	---------------------	-----

30.01.2015	Nordjysk mesterskab 2015	Aalborg Skyttekreds
------------	--------------------------	---------------------

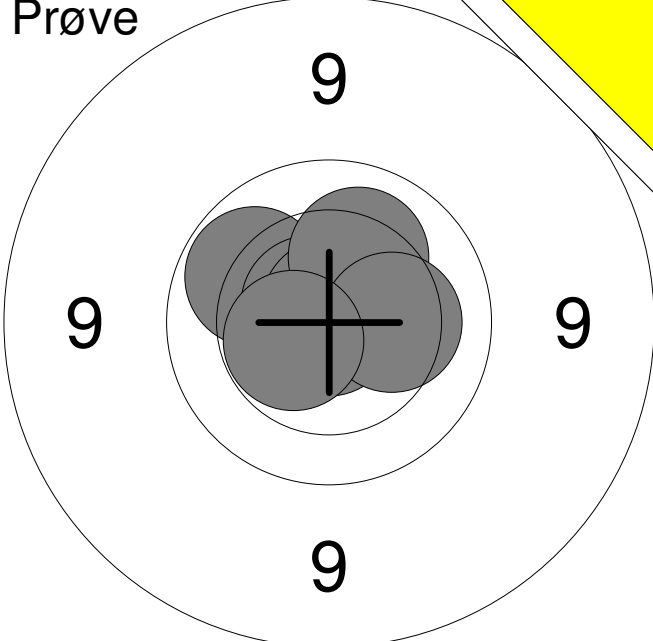
<b>Prøve</b> 	1:	10.0	↗
	2:	10.9x	↓
	3:	10.7x	←
	4:	10.7x	↗
	5:	10.8x	↑
	6:	10.2	↗
	7:	10.3	→
	8:	10.5x	↙
	<b>Serie</b>		<b>80.0</b>
	<b>Total</b>		<b>0.0</b>

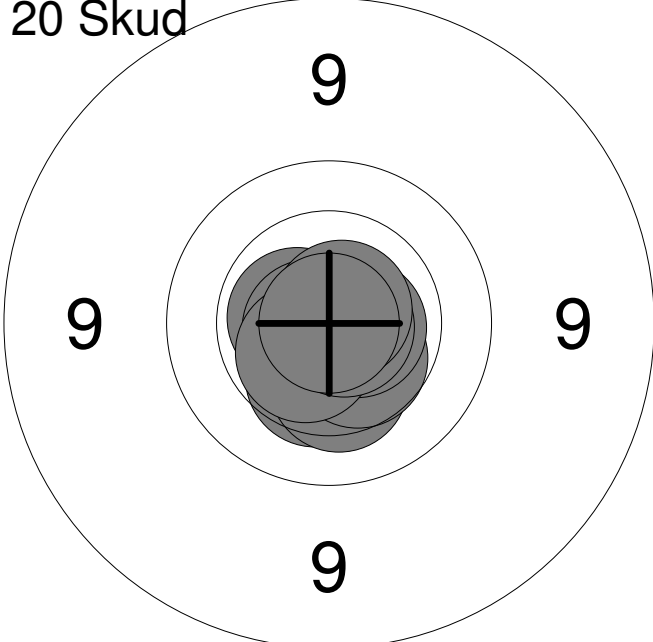
<b>20 Skud</b> 	1:	10.4	↓
	2:	10.3	↓
	3:	10.5	↓
	4:	10.6x	←
	5:	10.7x	→
	6:	10.8x	←
	7:	10.5x	↙
	8:	10.8x	→
	9:	10.7x	↗
	10:	10.9x	↗
	<b>Serie</b>		<b>100.0</b>
<b>Total</b>		<b>100.0</b>	

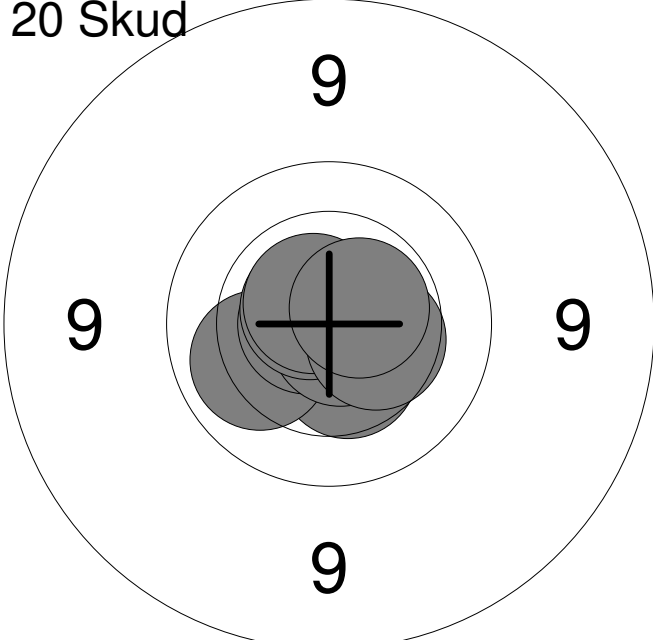
<b>20 Skud</b> 	11:	10.4	↓
	12:	10.1	↙
	13:	10.8x	↗
	14:	10.7x	←
	15:	10.8x	↙
	16:	10.8x	↗
	17:	10.7x	↗
	18:	10.7x	↗
	19:	10.4	↘
	20:	10.6x	↗
	<b>Serie</b>		<b>100.0</b>
<b>Total</b>		<b>200.0</b>	

Hold <b>14</b>	Skive <b>3</b>	<b>Daniel Larsen</b>
-------------------	-------------------	----------------------

15m	Vester Hassing Skf.	BK3
-----	---------------------	-----

30.01.2015	Nordjysk mesterskab 2015	Aalborg Skyttekreds
------------	--------------------------	---------------------

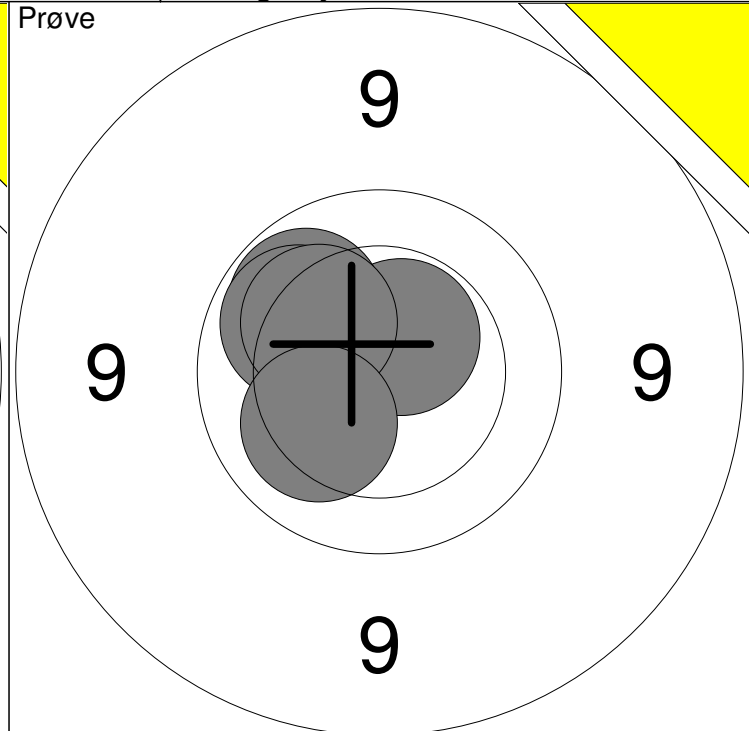
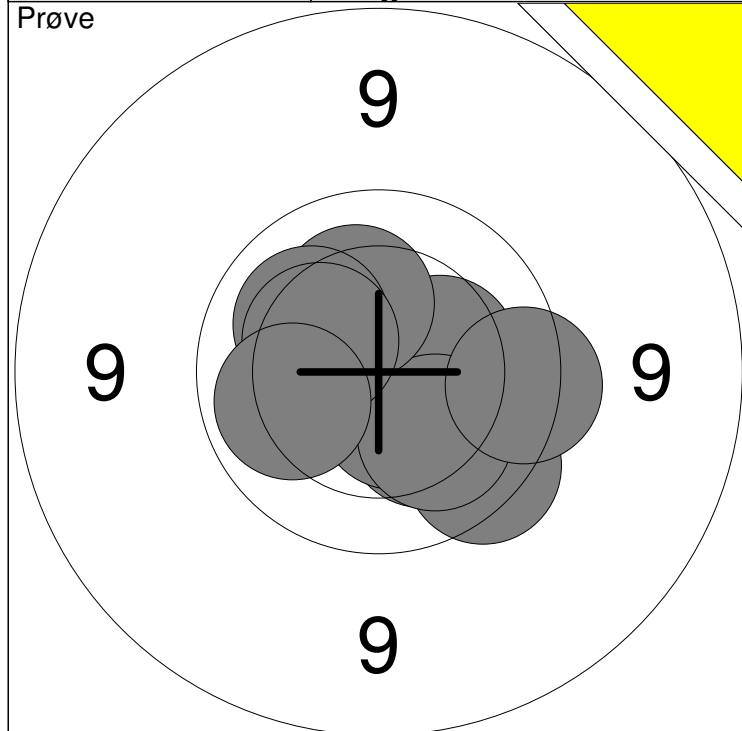

1: 10.3 ↘	6: 10.3 ↗	Serie	98
2: 10.5x ↘	7: 10.2 ↗		
3: 9.7 ↘	8: 9.7 →	Total	0
4: 10.3 →	9: 10.3 ↖		
5: 10.1 ↘	10: 10.1 ←		

11: 10.6x ↗	Serie	50
12: 10.0 ↗		
13: 10.0 ↗	Total	0
14: 10.2 ↖		
15: 10.2 ↙		

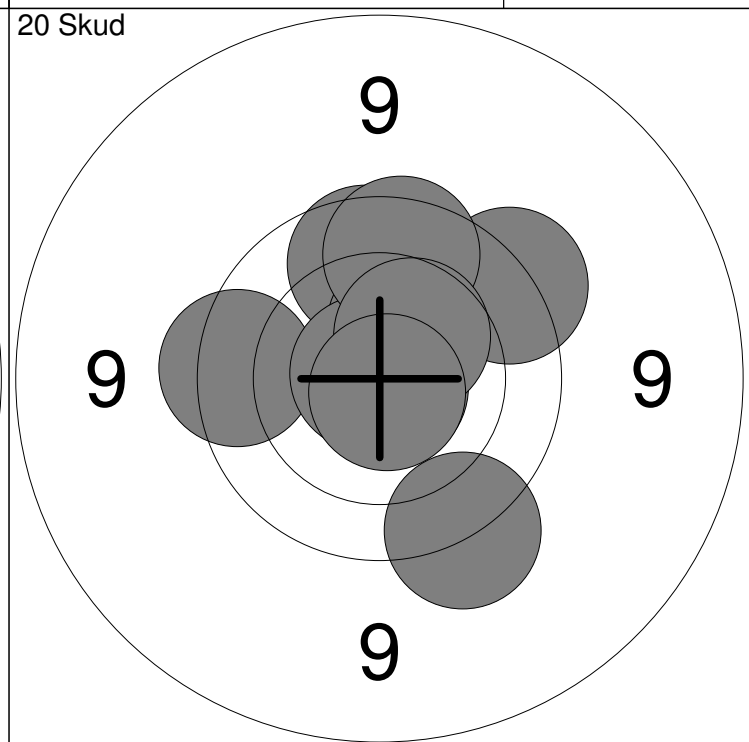
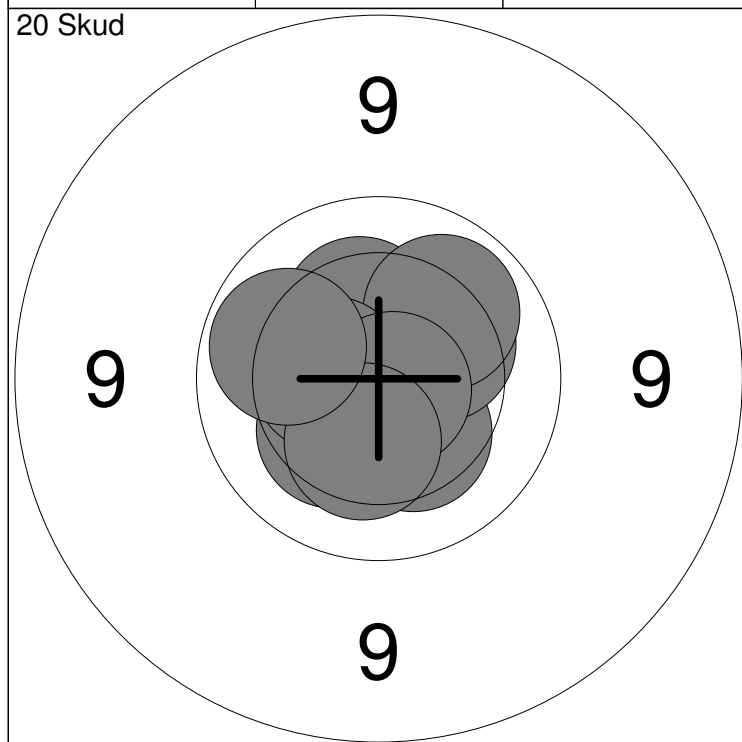

1: 10.3 ↘	6: 10.3 ↙	Serie	100
2: 10.3 ↗	7: 10.5 ←		
3: 10.3 ↗	8: 10.8x ↘	Total	100
4: 10.5x ↙	9: 10.3 ↘		
5: 10.1 ↗	10: 10.0 ←		

11: 10.8x ↘	16: 10.8x ↖	Serie	95
12: 9.9 ↗	17: 9.6 ↘		
13: 9.6 ↗	18: 9.8 ↗	Total	195
14: 9.7 ←	19: 10.4 ↗		
15: 10.4 ↗	20: 10.8x ↘		

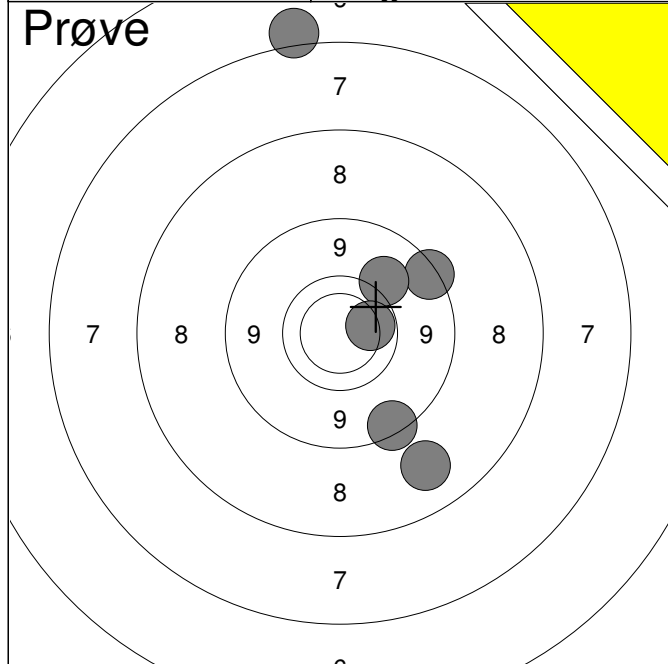

1:	6.5	↑
2:	8.8	↗
3:	8.2	↓
4:	8.8	↓
5:	9.3	↗
6:	10.0	→
<b>Serie</b>		<b>49.0</b>
<b>Total</b>		<b>0.0</b>

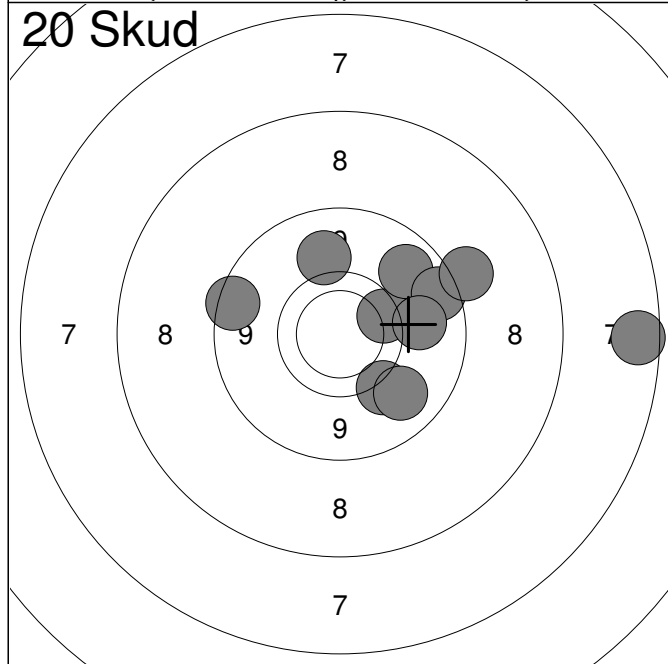

1:	9.8	→
2:	9.1	↗
3:	9.3	↑
4:	9.4	↓
5:	8.9	→
6:	6.9	→
7:	8.5	↗
8:	8.8	←
9:	9.2	→
10:	9.2	↓
<b>Serie</b>		<b>84.0</b>
<b>Total</b>		<b>84.0</b>

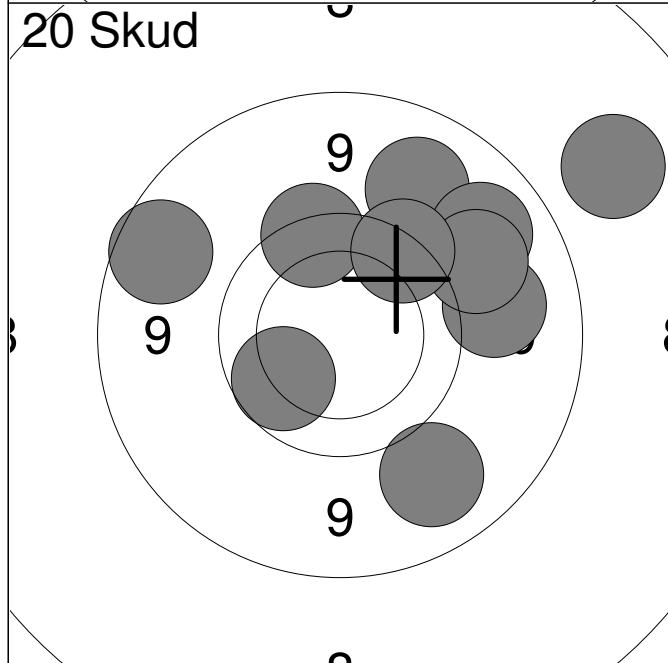

11:	9.7	↑
12:	9.1	↓
13:	8.3	↗
14:	9.2	↗
15:	8.9	←
16:	9.1	↗
17:	9.2	→
18:	9.2	↗
19:	9.7	↗
20:	9.9	↙
<b>Serie</b>		<b>88.0</b>
<b>Total</b>		<b>172.0</b>

Hold	Skive	Mikkel Hartmann Johansen	
14	5		
15m	Sæby og Omegns Skytteforening	BK2	
30.01.2015	Nordjysk mesterskab 2015	Aalborg Skyttekreds	
Prøve	8	1: 9.5	↘
	9	2: 10.0	←
	9	3: 10.0	↑
	9	4: 10.1	←
	9	5: 10.2	↗
	9	6: 8.1	↘
	9	7: 10.6x	←
	8		
Serie		67.0	
Total		0.0	
20 Skud	9	1: 10.2	↙
	9	2: 10.5	↙
	9	3: 9.9	↙
	9	4: 10.5x	↙
	9	5: 10.6x	↙
	9	6: 10.1	←
	9	7: 10.4	↑
	9	8: 10.5	←
	9	9: 10.7x	↙
	9	10: 10.6x	↗
	Serie		99.0
Total		99.0	
20 Skud	9	11: 10.2	↑
	9	12: 9.8	↑
	9	13: 10.5x	↗
	9	14: 9.7	↑
	9	15: 10.5x	↘
	9	16: 10.5x	↙
	9	17: 9.7	←
	9	18: 10.5x	↘
	9	19: 10.0	↘
	9	20: 10.9x	↗
	Serie		97.0
Total		196.0	

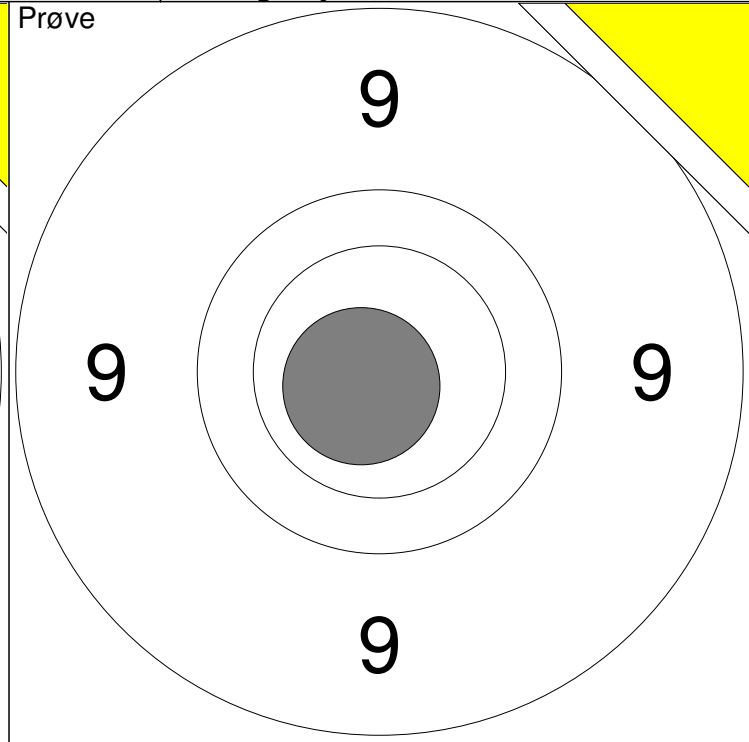
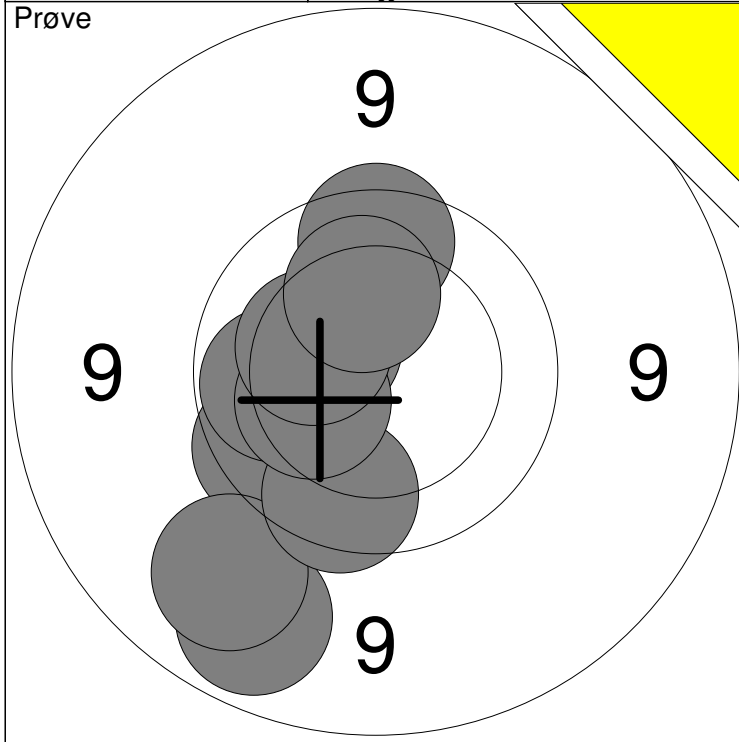

1: 9.8 ↙	6: 10.4 ↖	Serie	95
2: 9.0 ↘	7: 10.3 ↙		
3: 9.2 ↘	8: 10.3 ↙	Total	0
4: 9.8 ↘	9: 9.8 ↑		
5: 10.0 ←	10: 10.2 ↑		

11: 10.7x ↙	Serie	10
	Total	0

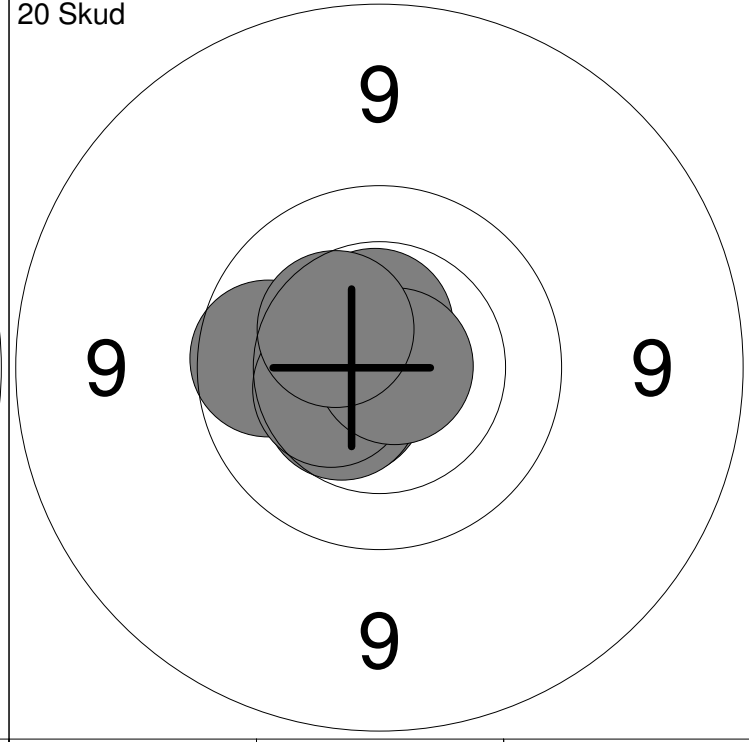
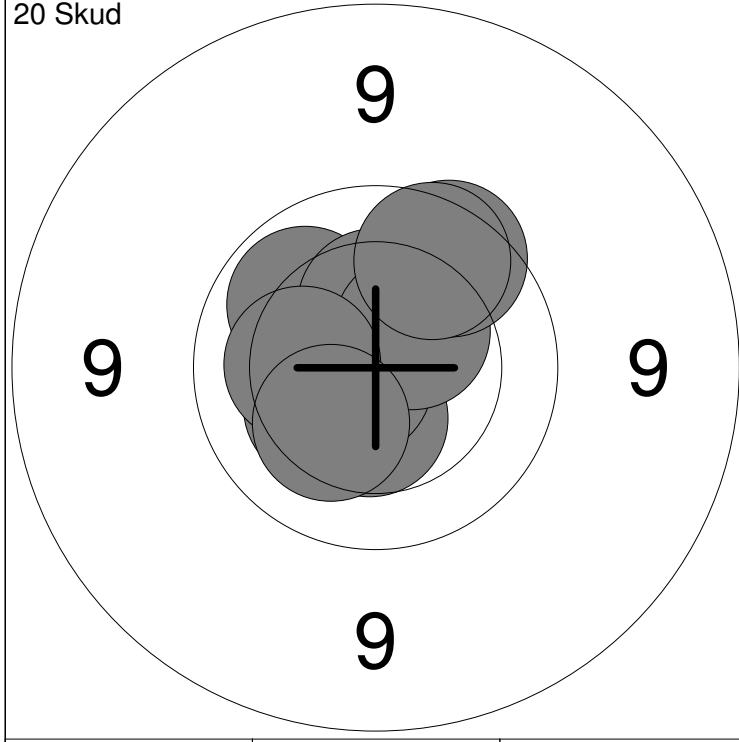

1: 10.3 ↙	6: 10.5 ↗	Serie	98
2: 10.5 ↓	7: 10.2 ←		
3: 10.7x ↙	8: 9.8 ↗	Total	98
4: 10.0 ↖	9: 10.3 ↘		
5: 10.4 ↑	10: 9.9 ↗		

11: 10.5x ↙	16: 9.9 ←	Serie	99
12: 10.5 ←	17: 10.5 ↘		
13: 10.8x ↖	18: 10.4 ←	Total	197
14: 10.5x ←	19: 10.8x →		
15: 10.6x ↑	20: 10.4 ↘		



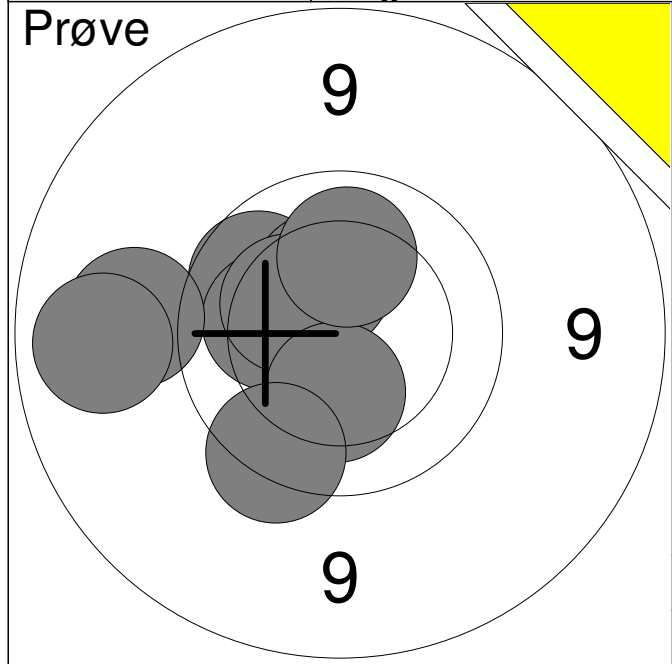

1:	9.9	↗
2:	10.2	↖
3:	9.3	↖
4:	10.4	↗
5:	9.1	↖
6:	10.3	↗
7:	10.3	↓
8:	10.1	↑
9:	9.7	↘

<b>Serie</b>	<b>86.0</b>
<b>Total</b>	<b>0.0</b>

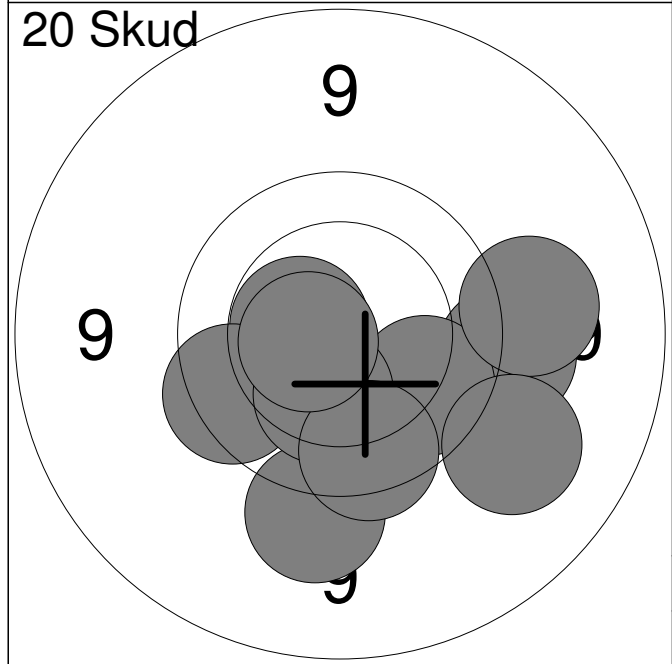

1:	10.5x	↖
2:	9.8	↖
3:	9.5	→
4:	9.9	↘
5:	9.4	↓
6:	10.3	↓
7:	9.8	↓
8:	9.3	→
9:	10.6x	↖
10:	9.3	↘

<b>Serie</b>	<b>93.0</b>
<b>Total</b>	<b>93.0</b>

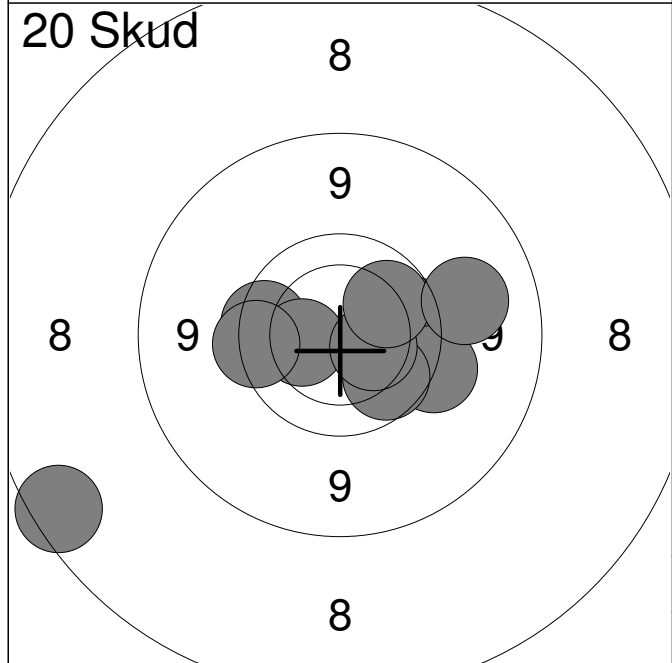

11:	9.8	→
12:	9.8	↖
13:	9.5	↘
14:	10.3	↖
15:	9.9	↘
16:	10.3	↘
17:	7.8	↖
18:	9.7	↖
19:	10.0	↗
20:	9.2	→

<b>Serie</b>	<b>91.0</b>
<b>Total</b>	<b>184.0</b>

Hold	Skive	Sune Grøn Bendixen		
14	9	Hjørring Skytteforening		MB2
30.01.2015	Nordjysk mesterskab 2015		Aalborg Skyttekreds	
Prøve		1:	10.3	→
		2:	10.0	↑
		3:	10.4	→
		4:	10.2	→
		5:	10.0	←
		6:	10.2	↓
		<b>Serie</b>	<b>60.0</b>	
		<b>Total</b>	<b>0.0</b>	
20 Skud		1:	10.2	↙
		2:	10.3	↓
		3:	10.2	↘
		4:	9.9	←
		5:	10.7x	←
		6:	10.3	←
		7:	10.8x	↑
		8:	10.9x	←
		9:	10.0	←
		10:	10.6x	↙
		<b>Serie</b>	<b>99.0</b>	
		<b>Total</b>	<b>99.0</b>	
20 Skud		11:	10.2	←
		12:	10.8x	←
		13:	10.4	↗
		14:	10.5	↙
		15:	10.1	↘
		16:	10.2	←
		17:	10.1	↑
		18:	9.9	←
		19:	10.5x	↙
		20:	10.3	←
		<b>Serie</b>	<b>99.0</b>	
		<b>Total</b>	<b>198.0</b>	

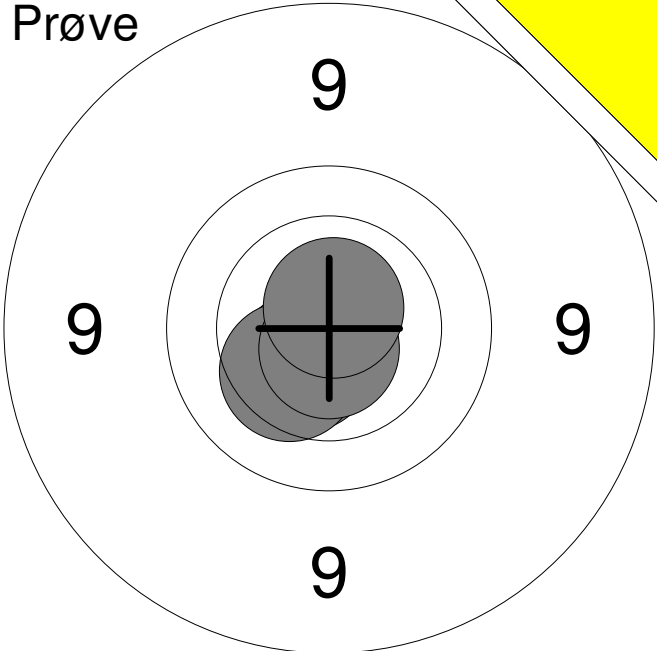
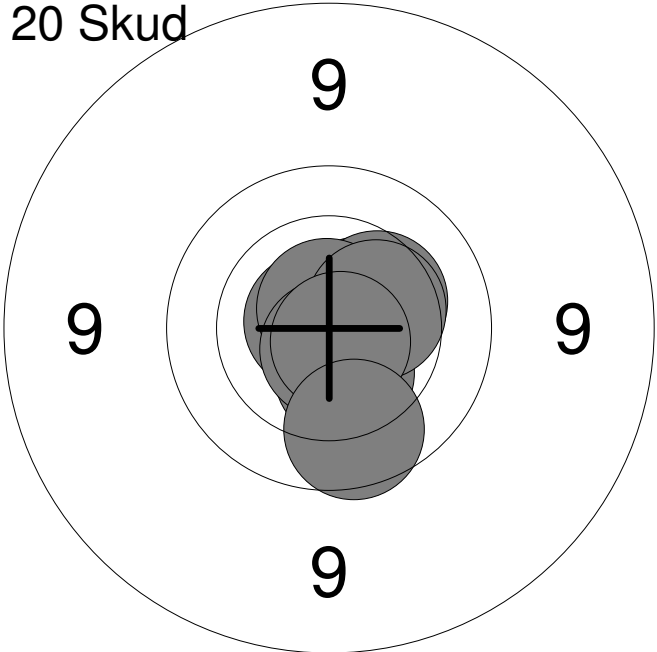
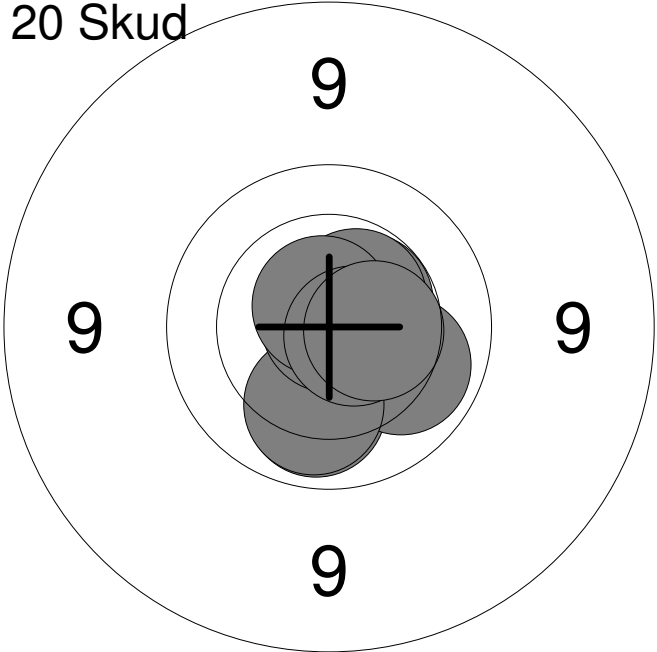
Hold	Skive	Thomas Grøn Bendixen		
14	11	Hjørring Skytteforening		MB1
15m	Nordjysk mesterskab 2015		Aalborg Skyttekreds	
30.01.2015				
Prøve		1: 10.8x	↘	
		2: 10.5x	↘	
		3: 10.3	↘	
		4: 10.7x	↓	
		5: 10.7x	↑	
		<b>Serie</b>	<b>50.0</b>	
		<b>Total</b>	<b>0.0</b>	
20 Skud		1: 10.8x	↖	
		2: 10.5x	↗	
		3: 10.4	↓	
		4: 10.3	↗	
		5: 10.7x	↓	
		6: 10.7x	↑	
		7: 10.7x	↓	
		8: 10.4	↗	
		9: 10.8x	↓	
		10: 9.9	↓	
		<b>Serie</b>	<b>99.0</b>	
		<b>Total</b>	<b>99.0</b>	
20 Skud		11: 10.5x	↗	
		12: 10.5x	↗	
		13: 10.1	↓	
		14: 10.5x	↗	
		15: 10.1	↗	
		16: 10.1	↓	
		17: 10.9x	↗	
		18: 10.7x	↗	
		19: 10.7x	↗	
		20: 10.5	→	
		<b>Serie</b>	<b>100.0</b>	
		<b>Total</b>	<b>199.0</b>	

Hold <b>14</b>	Skive <b>12</b>	<b>Mikkel Lyberth Nielsen</b>	
-------------------	--------------------	-------------------------------	--

15m	Hjørring Skytteforening	MB4	
-----	-------------------------	-----	--

30.01.2015	Nordjysk mesterskab 2015	Aalborg Skyttekreds	
------------	--------------------------	---------------------	--

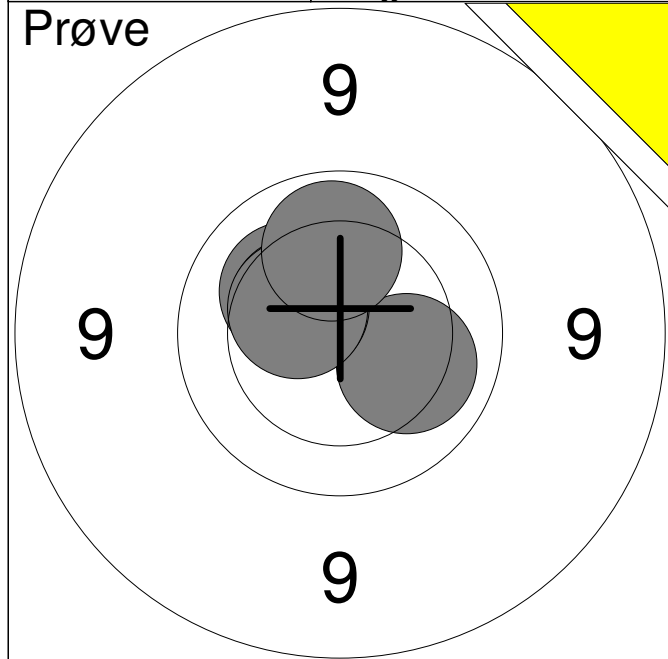

1:	10.2	↗
2:	10.2	↘
3:	10.4	↗
4:	10.4	↗
5:	10.1	↑

Serie	50.0
Total	0.0

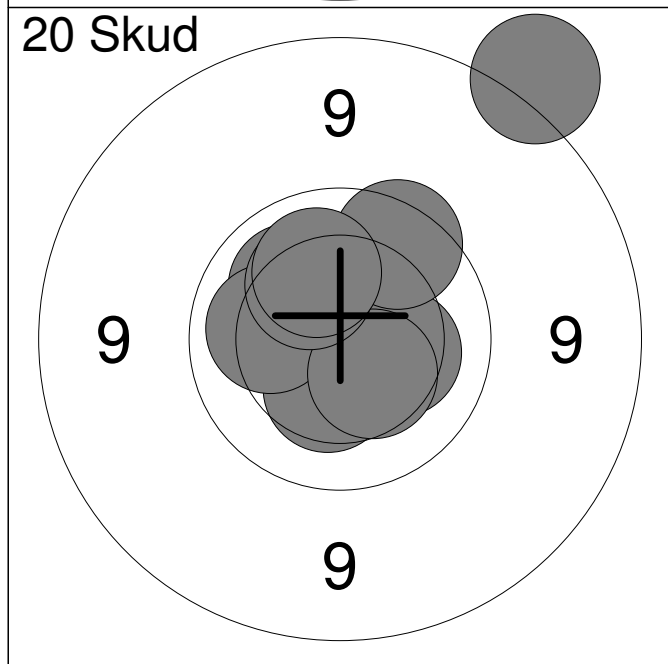

1:	10.6x	↖
2:	10.4	↘
3:	10.3	→
4:	8.6	↗
5:	10.1	↗
6:	9.8	↗
7:	10.1	←
8:	10.4	↘
9:	10.2	↗
10:	10.1	↗

Serie	97.0
Total	97.0

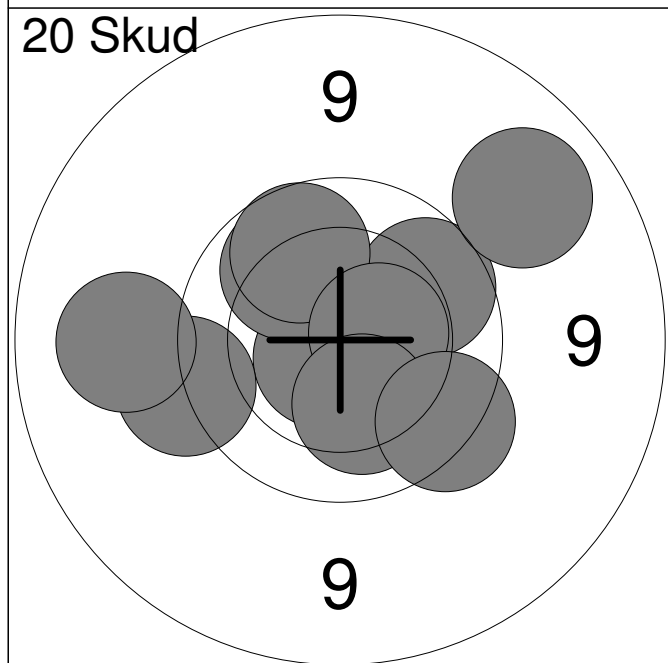

11:	10.7x	↙
12:	9.9	↗
13:	9.5	←
14:	10.0	↗
15:	9.2	←
16:	9.9	↗
17:	10.5x	→
18:	9.1	↗
19:	10.2	↘
20:	9.7	↘

Serie	94.0
Total	191.0

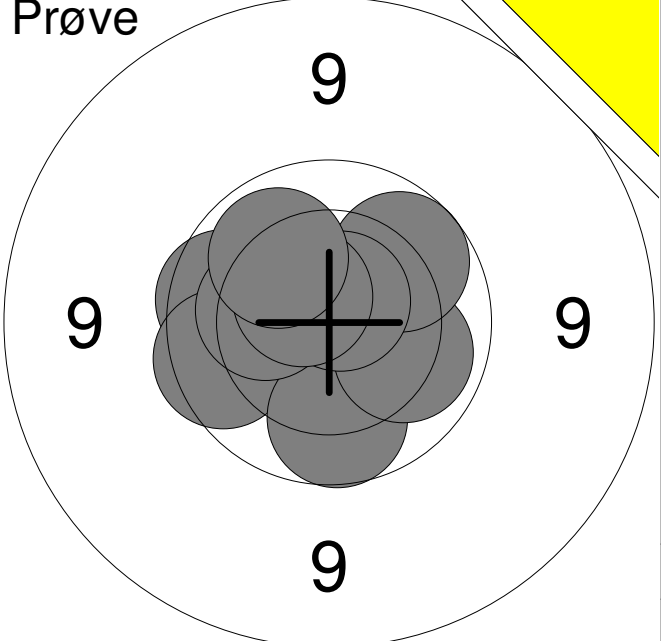
<b>Prøve</b> 	1:	9.9	←
	2:	9.8	←
	3:	9.9	↓
	4:	10.3	←
	5:	10.1	→
	6:	9.9	↗
	7:	10.7x	↗
	8:	10.5x	↗
	9:	10.1	↗
	<b>Serie</b>		<b>86.0</b>
<b>Total</b>		<b>0.0</b>	

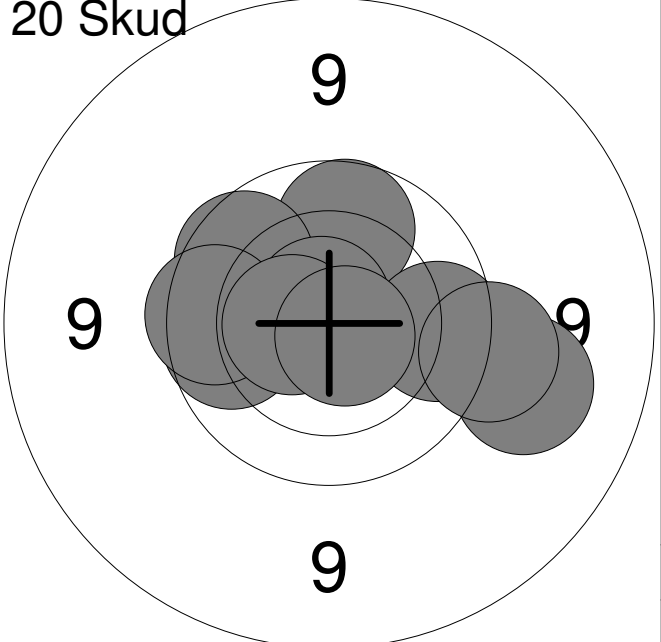
<b>20 Skud</b> 	1:	9.9	←
	2:	9.9	↑
	3:	9.9	↗
	4:	9.8	←
	5:	10.7x	↗
	6:	9.8	→
	7:	10.5x	←
	8:	10.7x	↓
	9:	9.3	→
	10:	9.5	→
<b>Serie</b>		<b>93.0</b>	
<b>Total</b>		<b>93.0</b>	

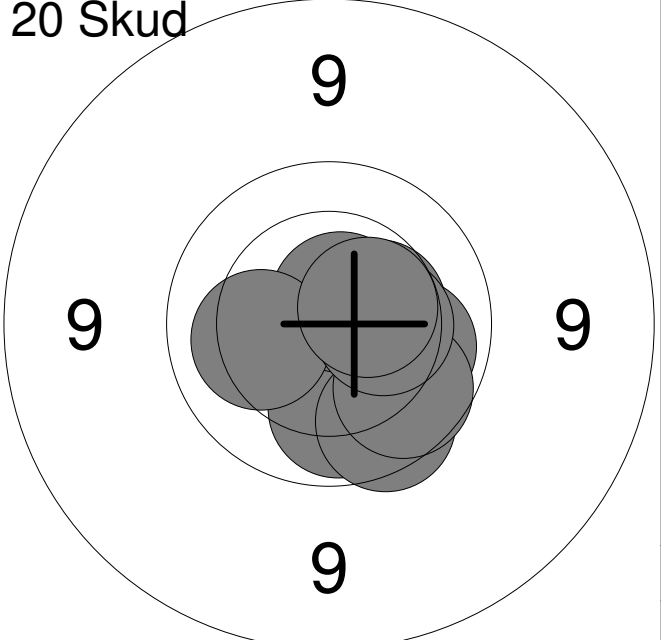
<b>20 Skud</b> 	11:	10.4	→
	12:	10.1	→
	13:	10.0	↓
	14:	9.8	↓
	15:	9.9	↓
	16:	10.7x	↗
	17:	10.2	←
	18:	10.4	→
	19:	10.4	→
	20:	10.5x	↗
<b>Serie</b>		<b>98.0</b>	
<b>Total</b>		<b>191.0</b>	

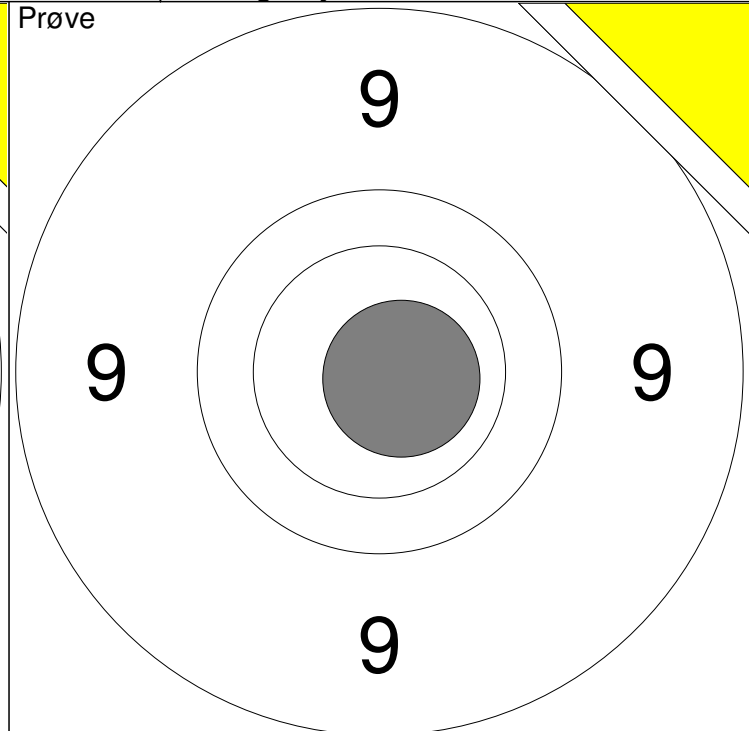
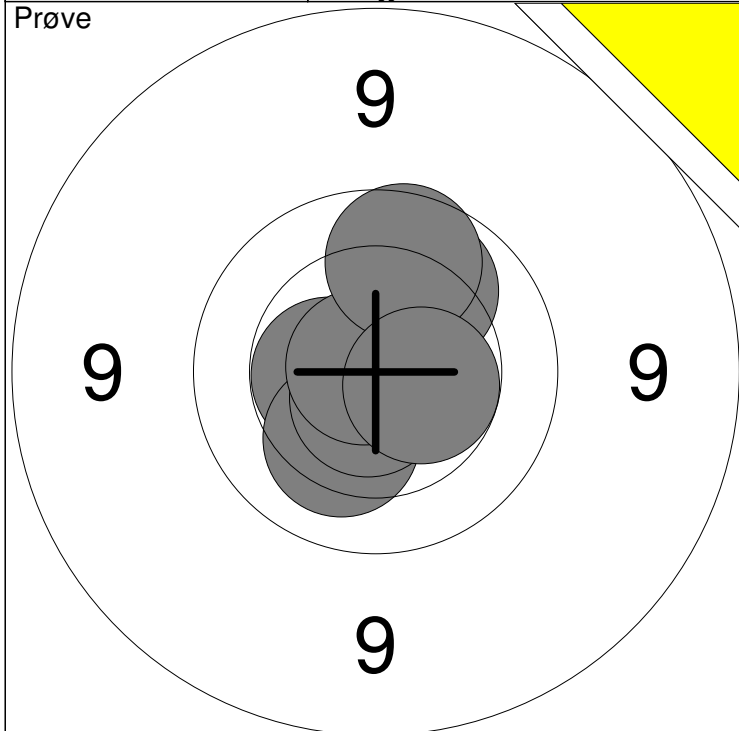

1: 10.8x ↘	6: 10.7x ↓	Serie	99
2: 10.8x ↙	7: 10.1 ↗		
3: 10.5x ←	8: 10.8x ↖	Total	0
4: 10.8x ↓	9: 9.9 ↗		
5: 10.2 ↙	10: 10.5x →		

11: 10.7x →	Serie	10
	Total	0

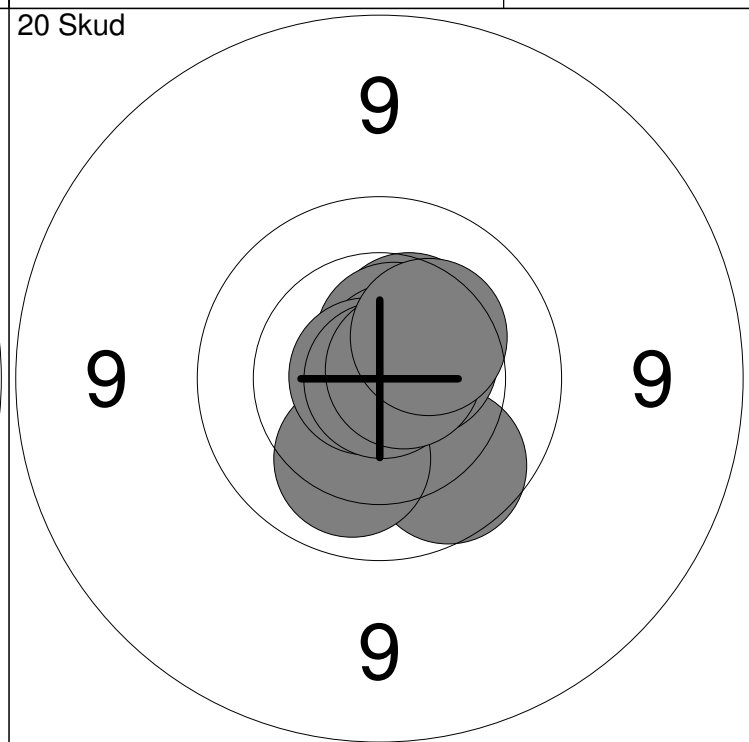
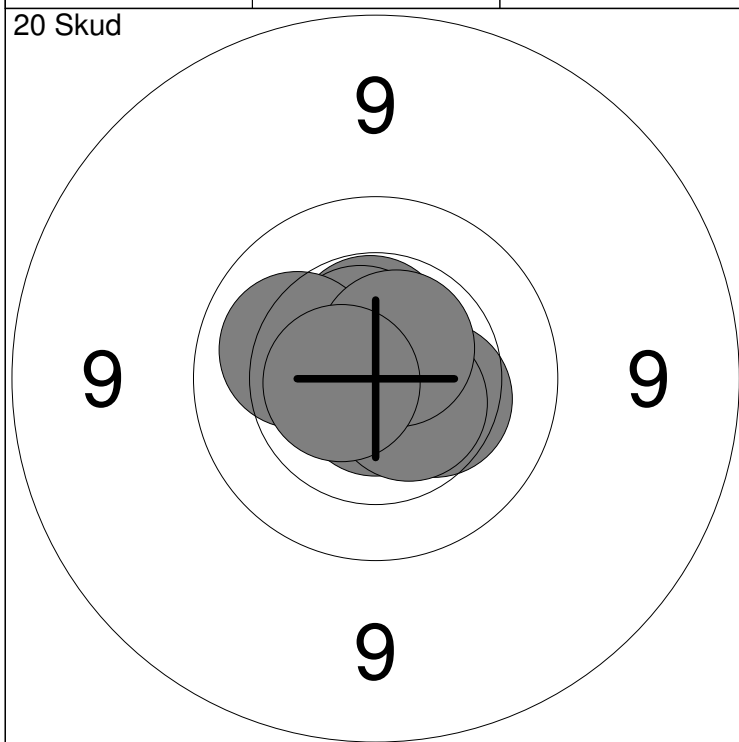

1: 10.8x ↓	6: 10.8x ↗	Serie	100
2: 10.8x ↗	7: 10.4 →		
3: 10.5x ↗	8: 10.6x ↘	Total	100
4: 10.6x ↗	9: 10.6x ↗		
5: 10.2 ↖	10: 10.6x ←		

11: 10.4 ↗	16: 10.1 ↓	Serie	99
12: 9.9 ↘	17: 10.8x ←		
13: 10.5x ↗	18: 10.9x →	Total	199
14: 10.6x ↗	19: 10.7x →		
15: 10.7x ↗	20: 10.3 ↗		

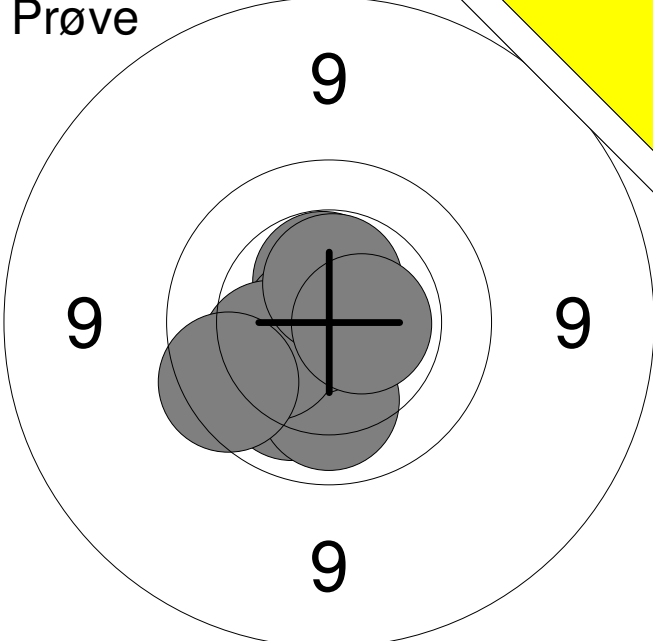
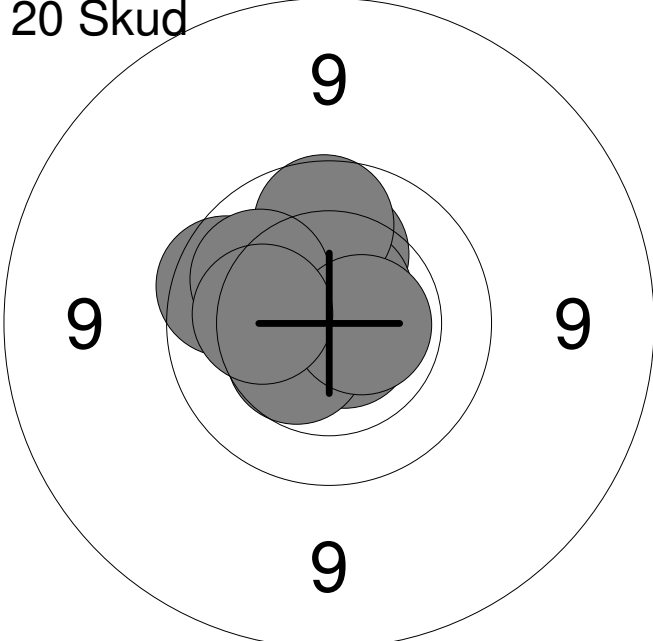
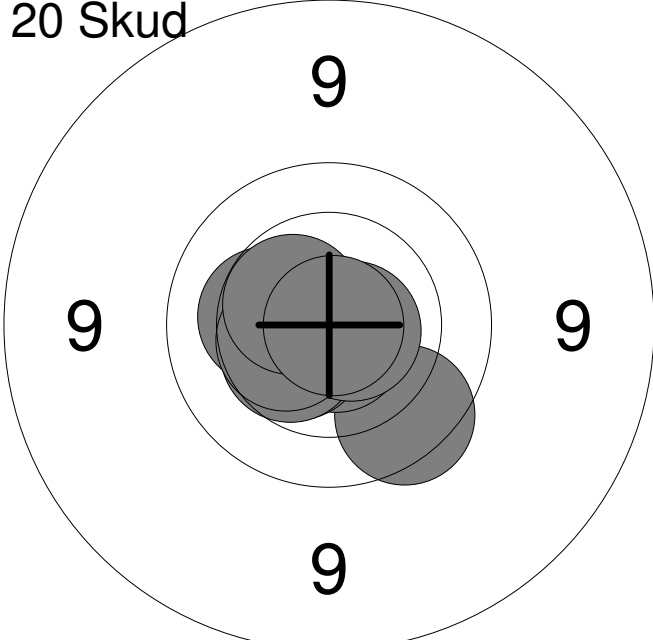
Hold	Skive	Emil Hedemann	
15	3	Vester Hassing Skf.	BK2
30.01.2015	Nordjysk mesterskab 2015	Aalborg Skyttekreds	
Prøve		1: 10.5x	↑
		2: 10.1	↙
		3: 10.1	↓
		4: 10.8x	←
		5: 10.3	↙
		6: 9.8	↙
		7: 10.5x	↑
		8: 10.6x	→
		<b>Serie</b>	<b>79.0</b>
		<b>Total</b>	<b>0.0</b>
20 Skud		1: 10.2	↑
		2: 9.8	↙
		3: 10.9x	↗
		4: 10.7x	↘
		5: 10.6x	↗
		6: 9.9	↑
		7: 10.1	↗
		8: 10.5	↙
		9: 10.6x	→
		10: 10.2	↙
		<b>Serie</b>	<b>98.0</b>
		<b>Total</b>	<b>98.0</b>
20 Skud		11: 10.5	↙
		12: 9.8	↘
		13: 10.7x	↘
		14: 10.5x	↙
		15: 10.4	↙
		16: 10.3	↙
		17: 10.7x	→
		18: 10.5	↙
		19: 10.5x	↗
		20: 10.9x	→
		<b>Serie</b>	<b>99.0</b>
		<b>Total</b>	<b>197.0</b>

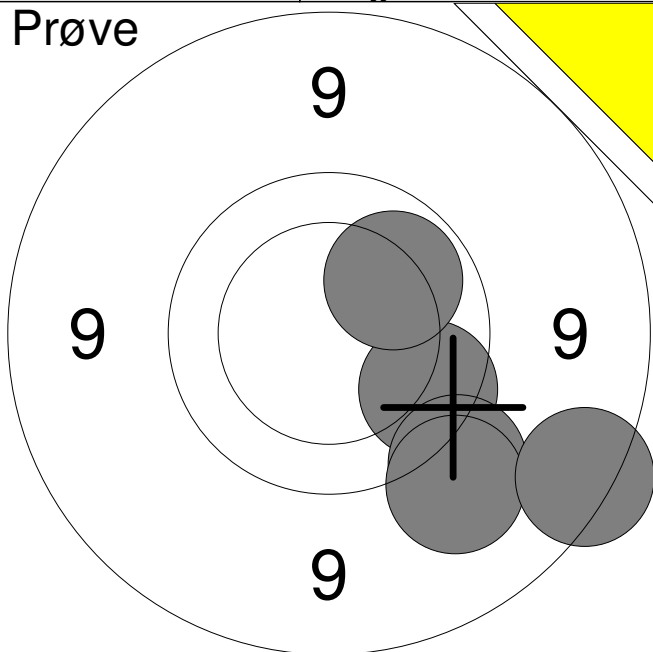
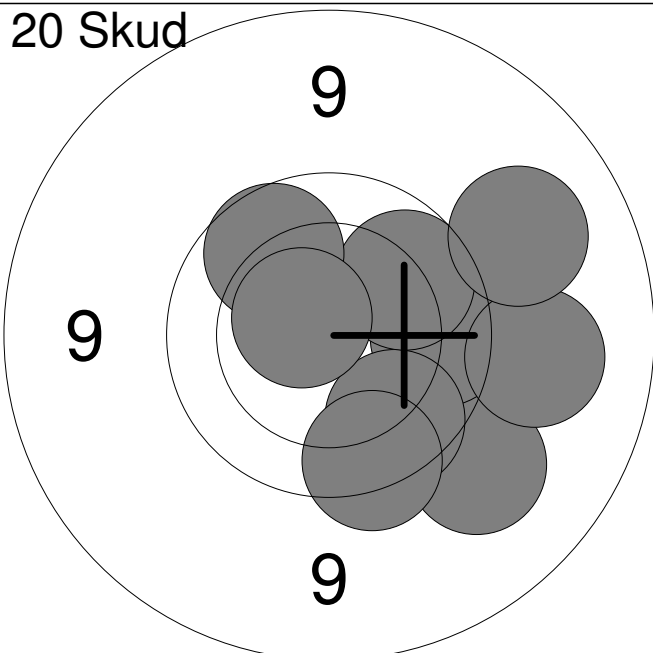
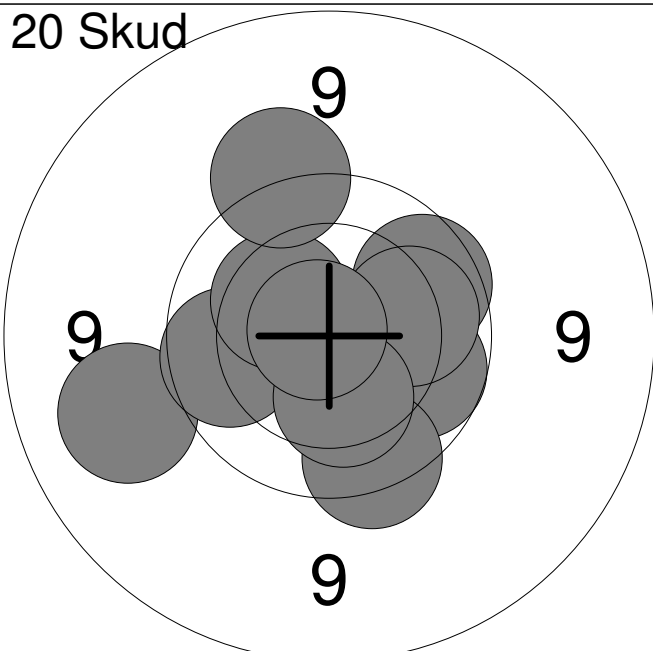
Hold	Skive	Nina Nielsen	
15m	Frederikshavn Skyttekreds	MJ2	
30.01.2015	Nordjysk mesterskab 2015	Aalborg Skyttekreds	
Prøve		1: 9.8 ↘	
		2: 9.4 ↘	
		3: 9.3 ↘	
		4: 8.8 ↘	
		5: 10.0 ↗	
	Serie	45.0	
	Total	0.0	
20 Skud		1: 9.8 ↘	
		2: 9.3 ↘	
		3: 9.8 →	
		4: 9.9 ↘	
		5: 9.2 →	
		6: 9.9 ↗	
		7: 9.9 ↗	
		8: 9.2 →	
		9: 10.6x ↗	
		10: 9.7 ↘	
	Serie	91.0	
	Total	91.0	
20 Skud		11: 9.9 ↗	
		12: 9.2 ←	
		13: 9.9 ←	
		14: 9.9 →	
		15: 9.7 ↘	
		16: 10.1 →	
		17: 10.3 ↘	
		18: 10.3 ↗	
		19: 10.8x ↗	
		20: 9.5 ↗	
	Serie	94.0	
	Total	185.0	

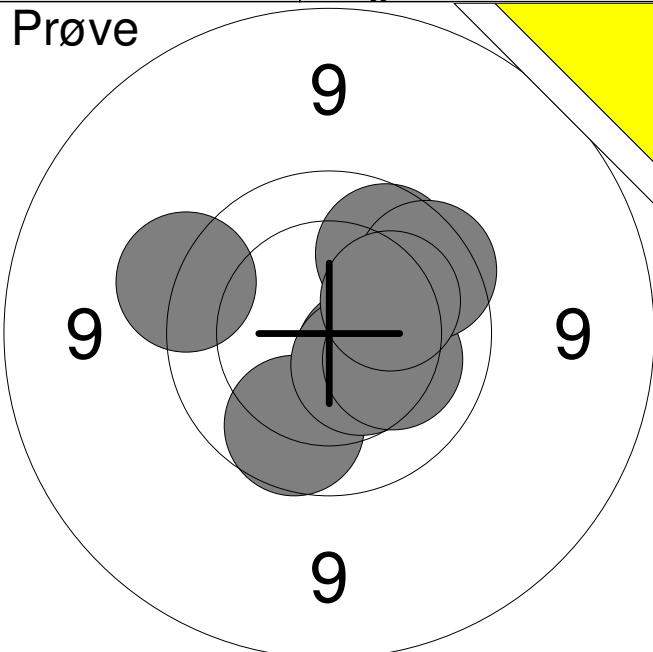
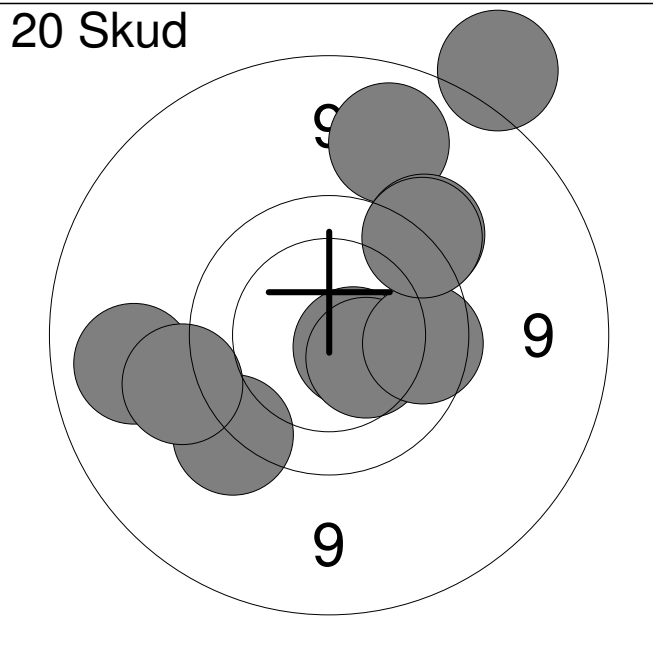
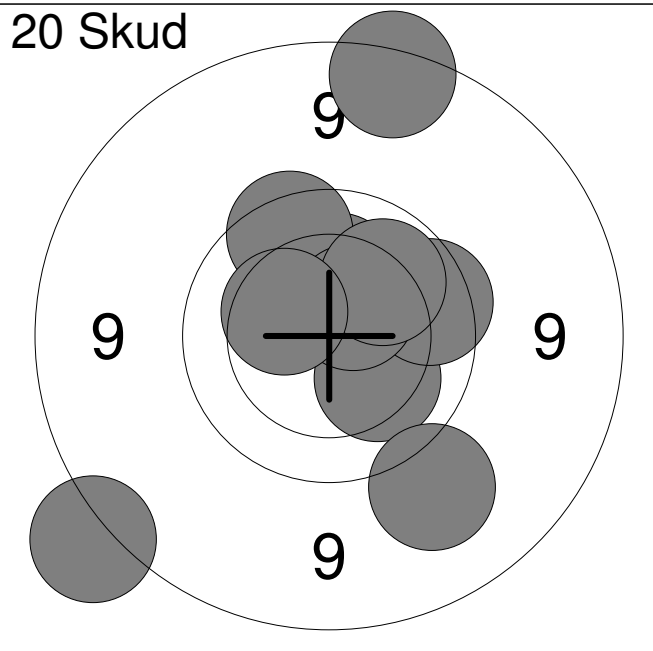

Hold	Skive	Lasse Dohn	
15	5		
15m	Sæby og Omegns Skytteforening	MB3	
30.01.2015	Nordjysk mesterskab 2015	Aalborg Skyttekreds	
Prøve		1: 10.5	↘
		2: 9.9	↙
		3: 10.5	↘
		4: 10.2	↘
		5: 9.9	↗
		6: 9.8	↗
		7: 9.6	↖
		8: 10.2	↗
		<b>Serie</b>	<b>76.0</b>
		<b>Total</b>	<b>0.0</b>
20 Skud		1: 10.6x	↘
		2: 8.5	↗
		3: 9.5	↙
		4: 10.4	↘
		5: 9.1	↗
		6: 9.8	→
		7: 9.5	↗
		8: 9.6	↗
		9: 9.1	↖
		10: 9.4	↖
		<b>Serie</b>	<b>91.0</b>
		<b>Total</b>	<b>91.0</b>
20 Skud		11: 10.2	↘
		12: 10.2	↗
		13: 9.3	↘
		14: 8.8	↗
		15: 9.8	→
		16: 8.6	↙
		17: 9.8	↗
		18: 10.5x	↗
		19: 10.0	↗
		20: 10.3	↖
		<b>Serie</b>	<b>93.0</b>
		<b>Total</b>	<b>184.0</b>

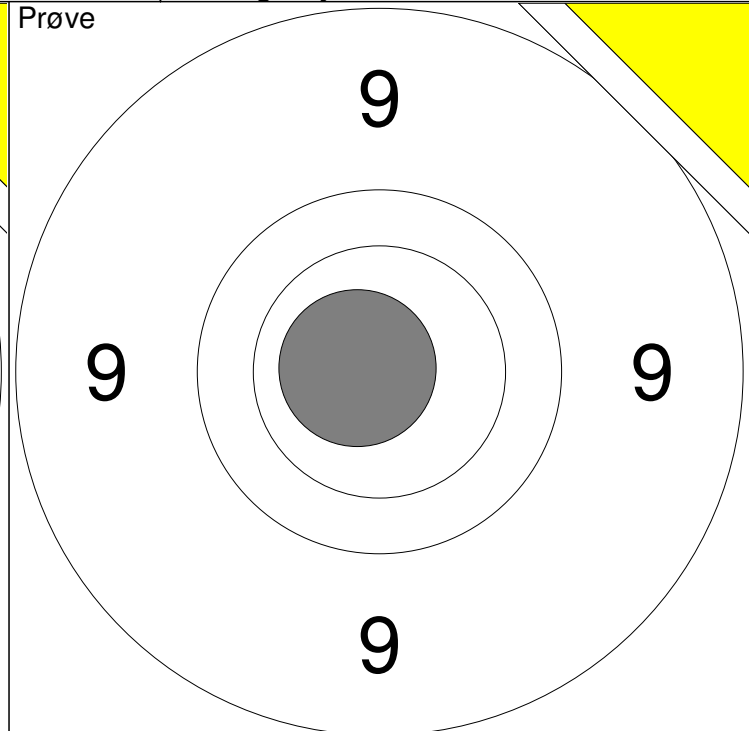
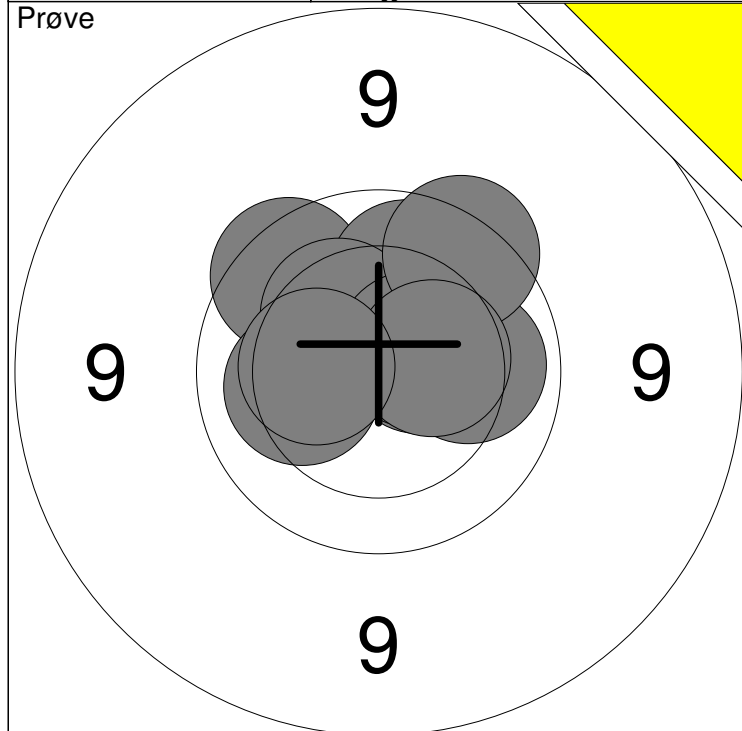

1: 9.8 ↗	6: 10.2 ←	Serie	98
2: 10.0 ↑	7: 10.5x ↗		
3: 10.3 ↗	8: 9.7 ↗	Total	0
4: 10.1 →	9: 10.4 →		
5: 10.5x →	10: 10.4 ←		

11: 10.7x ←		Serie	10
		Total	0

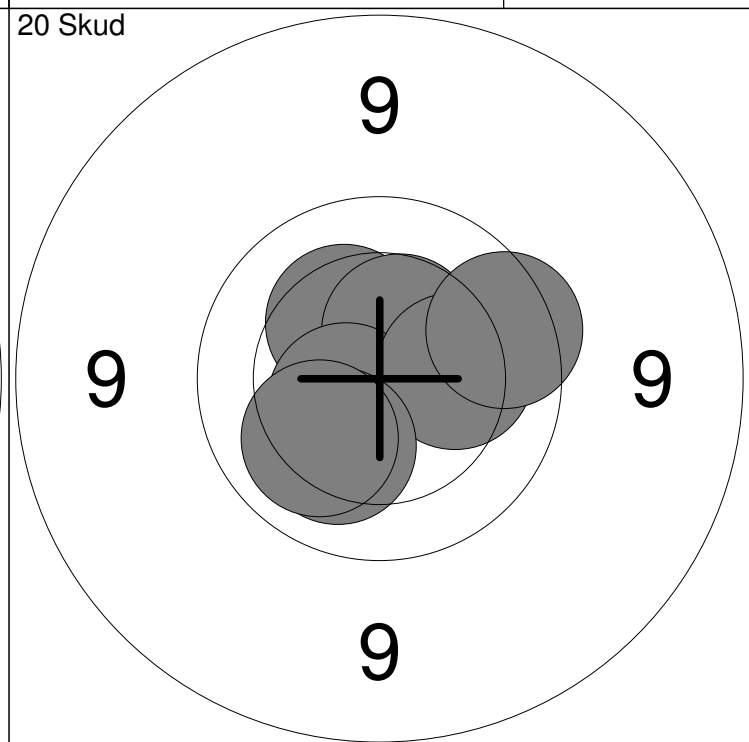
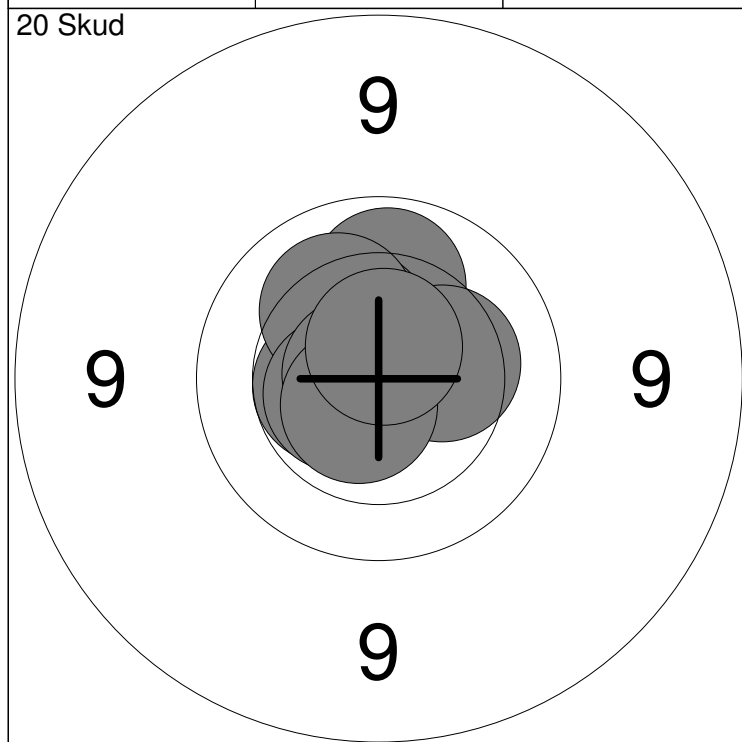

1: 10.1 ↑	6: 10.6x ←	Serie	100
2: 10.7x ↑	7: 10.3 →		
3: 10.5 ←	8: 10.8x ←	Total	100
4: 10.4 ↗	9: 10.6x ↘		
5: 10.2 ↗	10: 10.6x ↑		

11: 10.9x ↑	16: 10.6x ←	Serie	99
12: 10.5x ↑	17: 10.2 →		
13: 10.3 ↗	18: 9.8 →	Total	199
14: 10.2 ↘	19: 10.2 ↘		
15: 10.5 ↑	20: 10.1 ↘		

Hold	Skive	Emil Myrup Langgaard			
15	8	Løgstør Sportsskytteklub	J1		
30.01.2015	Nordjysk mesterskab 2015	Aalborg Skyttekreds			
Prøve		1:	10.7x	↑	
		2:	10.8x	↗	
		3:	10.3	↗	
		4:	10.4	←	
		5:	10.3	↗	
		6:	10.3	←	
		7:	10.6x	↘	
		8:	10.4	↗	
		Serie		80.0	
		Total		0.0	
20 Skud		1:	10.6x	↑	
		2:	10.6x	→	
		3:	10.5	→	
		4:	10.7x	→	
		5:	10.6x	→	
		6:	10.5x	↑	
		7:	10.5	→	
		8:	10.6x	↓	
		9:	10.6x	↓	
		10:	10.6x	↖	
Serie		100.0			
Total		100.0			
20 Skud		11:	10.4	←	
		12:	10.4	↘	
		13:	10.6x	↘	
		14:	10.1	↑	
		15:	10.7x	↗	
		16:	10.4	↗	
		17:	10.7x	↖	
		18:	10.0	↗	
		19:	10.8x	←	
		20:	10.6x	↗	
Serie		100.0			
Total		200.0			

Hold <b>15</b>	Skive <b>10</b>	<b>Klara Damsgaard</b>	
-------------------	--------------------	------------------------	--

15m	Års Skf.	J2
-----	----------	----

30.01.2015	Nordjysk mesterskab 2015	Aalborg Skyttekreds
------------	--------------------------	---------------------

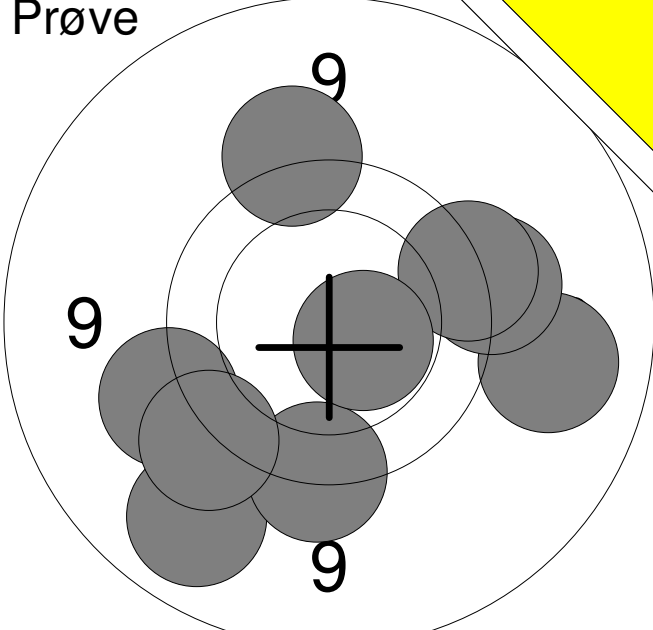
<b>Prøve</b> 	1:	9.5	↑
	2:	9.1	→
	3:	9.1	↙
	4:	9.5	→
	5:	9.6	→
	6:	9.4	↙
	7:	9.6	↓
	8:	10.5x	→
	9:	9.5	↙
	<b>Serie</b>		<b>82.0</b>
<b>Total</b>		<b>0.0</b>	

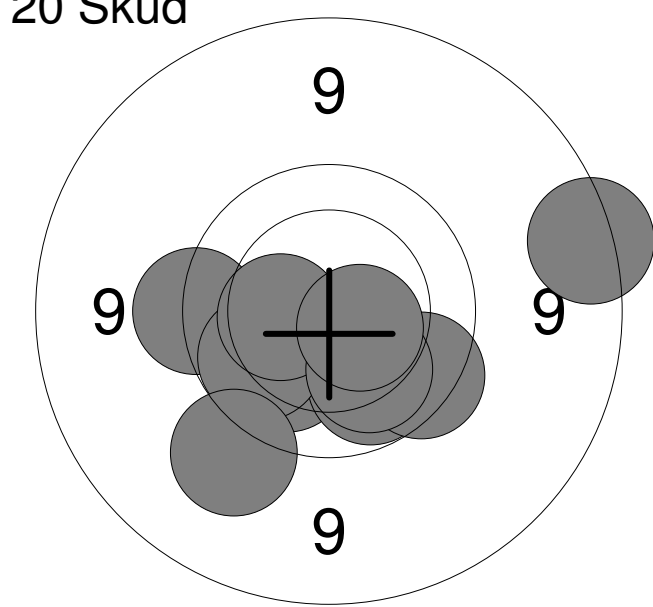
<b>20 Skud</b> 	1:	10.1	↙
	2:	10.0	↙
	3:	9.6	←
	4:	9.8	↘
	5:	10.0	↙
	6:	9.4	↙
	7:	10.4	←
	8:	10.1	↘
	9:	10.5x	↘
	10:	8.8	→
<b>Serie</b>		<b>95.0</b>	
<b>Total</b>		<b>95.0</b>	

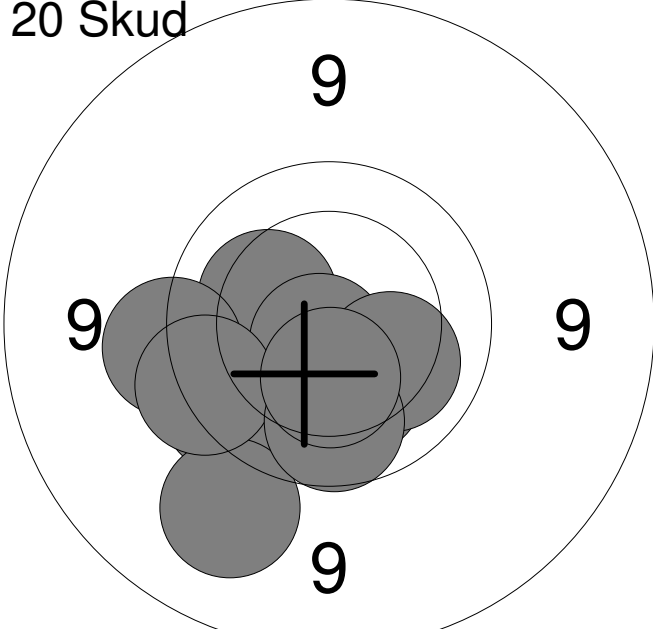
<b>20 Skud</b> 	11:	10.2	↘
	12:	10.2	↗
	13:	9.5	←
	14:	9.7	↙
	15:	9.2	↙
	16:	10.7x	↙
	17:	9.7	↙
	18:	10.2	↘
	19:	9.9	↓
	20:	10.4	↓
<b>Serie</b>		<b>95.0</b>	
<b>Total</b>		<b>190.0</b>	

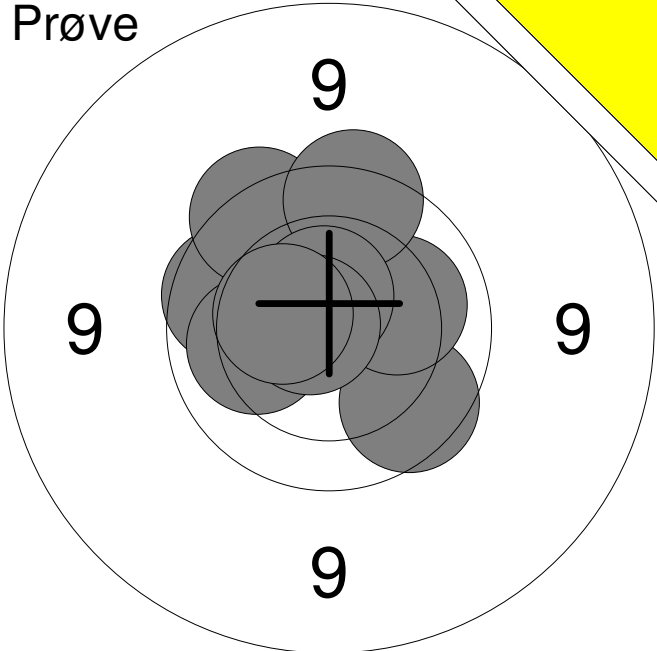
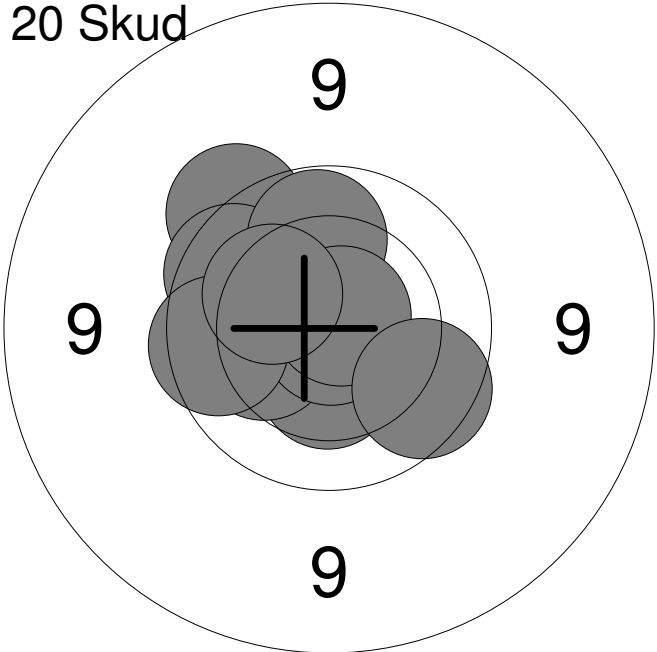
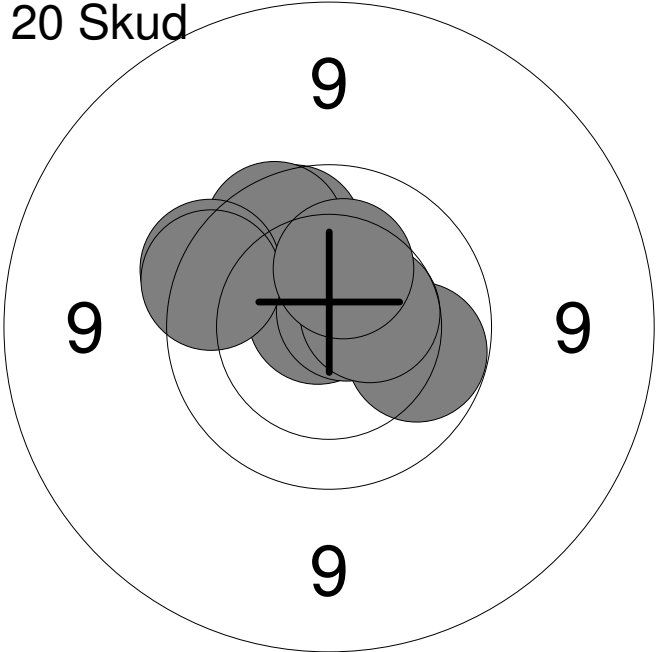
Hold	Skive	Freja Møller Pedersen	
15	11		
15m	Aalborg Skyttekreds	J2	
30.01.2015	Nordjysk mesterskab 2015	Aalborg Skyttekreds	
<b>Prøve</b> 	1:	9.8	↘
	2:	10.2	→
	3:	9.9	↖
	4:	9.7	↗
	5:	9.7	↑
	6:	10.1	↖
	7:	10.6x	↑
	8:	10.7x	↖
	9:	10.4	↖
	<b>Serie</b>		<b>86.0</b>
<b>Total</b>		<b>0.0</b>	
<b>20 Skud</b> 	1:	10.4	↓
	2:	9.6	↗
	3:	10.2	↖
	4:	9.8	↗
	5:	10.0	↑
	6:	10.9x	↓
	7:	10.8x	↗
	8:	9.8	↖
	9:	10.2	↗
	10:	9.8	↓
<b>Serie</b>		<b>96.0</b>	
<b>Total</b>		<b>96.0</b>	
<b>20 Skud</b> 	11:	10.6x	↗
	12:	9.9	↗
	13:	10.8x	↗
	14:	10.7x	↗
	15:	9.8	↗
	16:	9.7	↗
	17:	10.0	↘
	18:	10.5	↗
	19:	9.7	↖
	20:	10.3	↑
<b>Serie</b>		<b>96.0</b>	
<b>Total</b>		<b>192.0</b>	

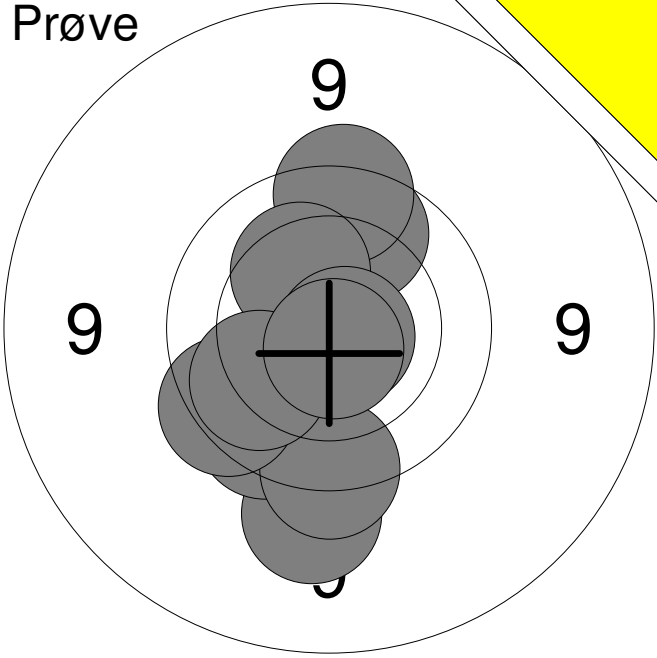
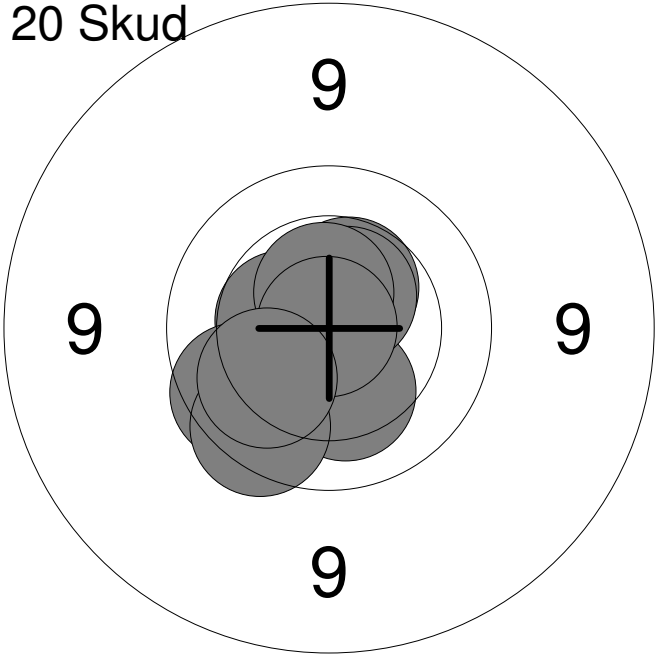
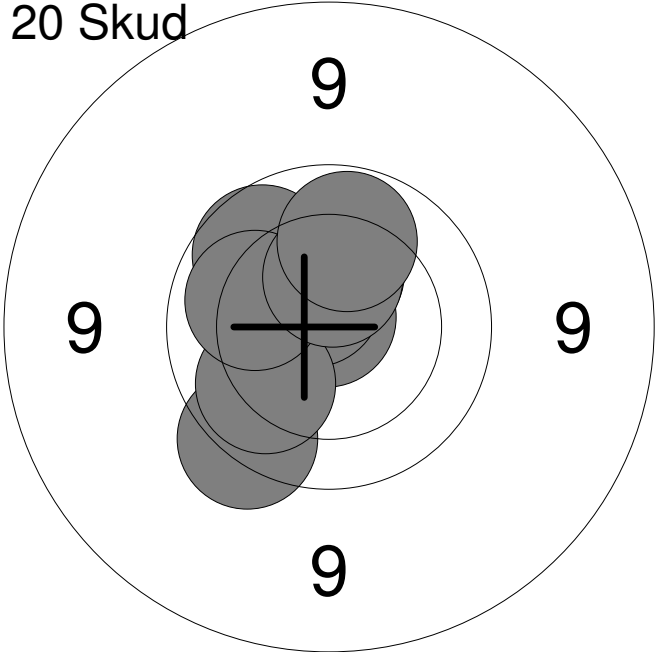
Hold	Skive	Peter A. Sørensen	
15	12		
15m	Aalborg Skyttekreds	MB2	
30.01.2015	Nordjysk mesterskab 2015	Aalborg Skyttekreds	
<b>Prøve</b> 	1:	9.4	↓
	2:	9.8	↙
	3:	9.9	↑
	4:	9.7	↑
	5:	10.3	↗
	6:	9.7	↓
	7:	10.8x	→
	8:	9.7	↙
	9:	10.0	↙
	10:	10.7x	↓
	<b>Serie</b>		<b>94.0</b>
<b>Total</b>		<b>0.0</b>	
<b>20 Skud</b> 	1:	10.5	←
	2:	10.5x	↙
	3:	10.3	↓
	4:	9.8	↙
	5:	9.8	↙
	6:	10.5	↑
	7:	10.6x	↗
	8:	10.6x	↑
	9:	10.9x	↗
	10:	10.1	↙
	<b>Serie</b>		<b>98.0</b>
<b>Total</b>		<b>98.0</b>	
<b>20 Skud</b> 	11:	10.8x	↑
	12:	10.2	↑
	13:	10.4	↑
	14:	9.7	↙
	15:	10.6x	↗
	16:	10.0	↙
	17:	9.9	↗
	18:	10.1	←
	19:	10.4	↑
	20:	10.0	↑
	<b>Serie</b>		<b>98.0</b>
<b>Total</b>		<b>196.0</b>	

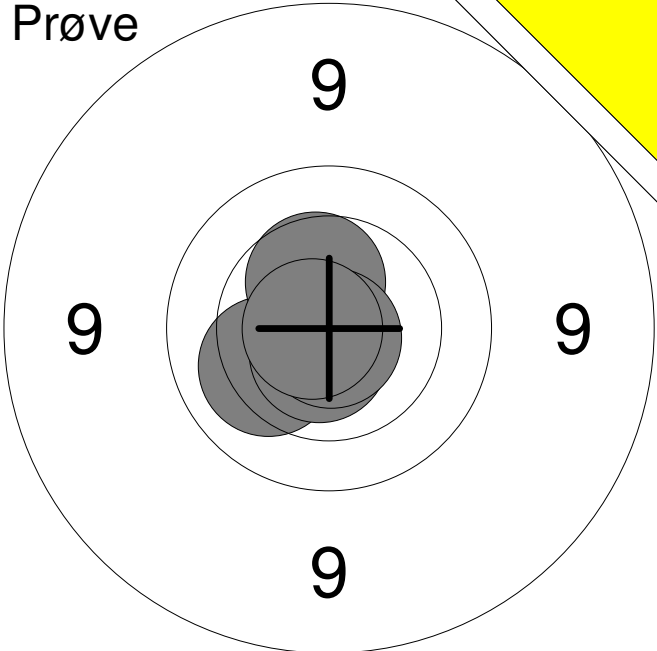
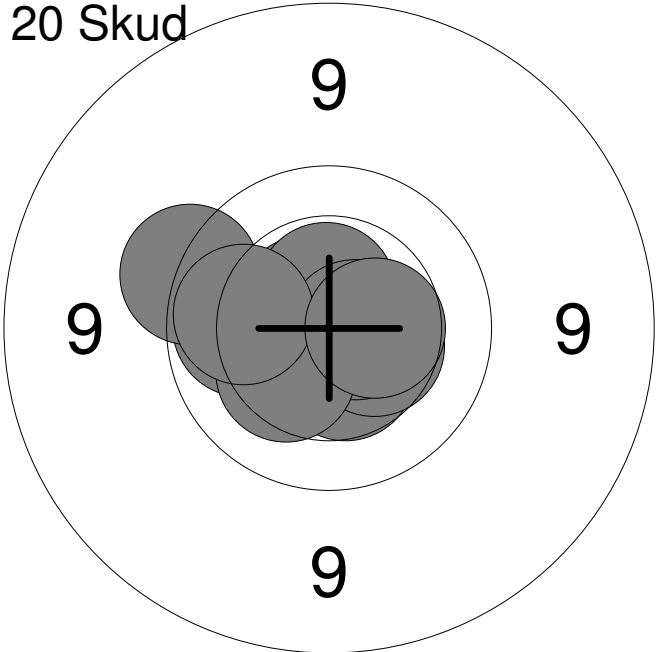
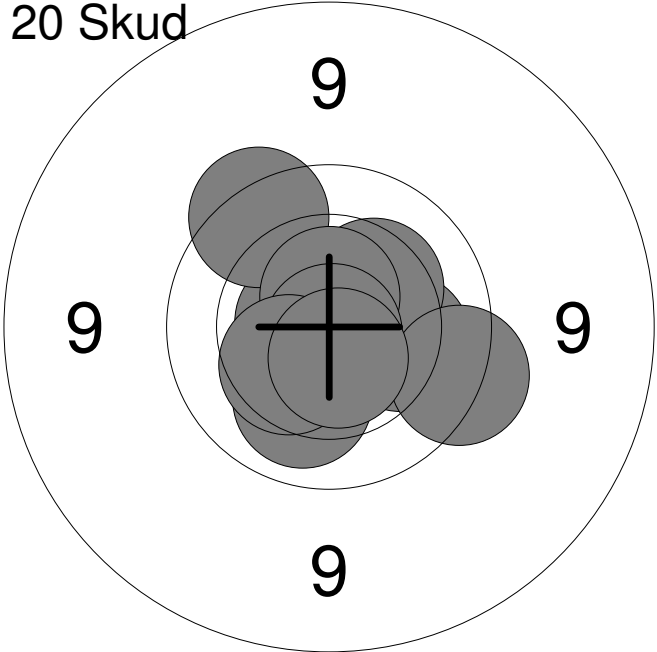
Hold	Skive	Karoline Jakobsen	
16	1		
15m	Vester Hassing Skf.	MB2	
30.01.2015	Nordjysk mesterskab 2015	Aalborg Skyttekreds	
Prøve		1: 10.2	↖
		2: 10.4	↑
		3: 10.7x	↘
		4: 10.8x	↘
		5: 10.8x	←
	Serie	50.0	
	Total	0.0	
20 Skud		1: 10.6x	↗
		2: 10.0	←
		3: 10.5	↘
		4: 9.6	↗
		5: 10.4	→
		6: 10.6x	↑
		7: 10.7x	→
		8: 10.3	↘
		9: 10.0	←
		10: 10.5	→
	Serie	99.0	
	Total	99.0	
20 Skud		11: 10.7x	←
		12: 9.7	↗
		13: 10.2	→
		14: 10.3	↗
		15: 10.1	↘
		16: 10.6x	↑
		17: 10.9x	↘
		18: 10.4	↘
		19: 9.7	→
		20: 10.6x	↘
	Serie	98.0	
	Total	197.0	

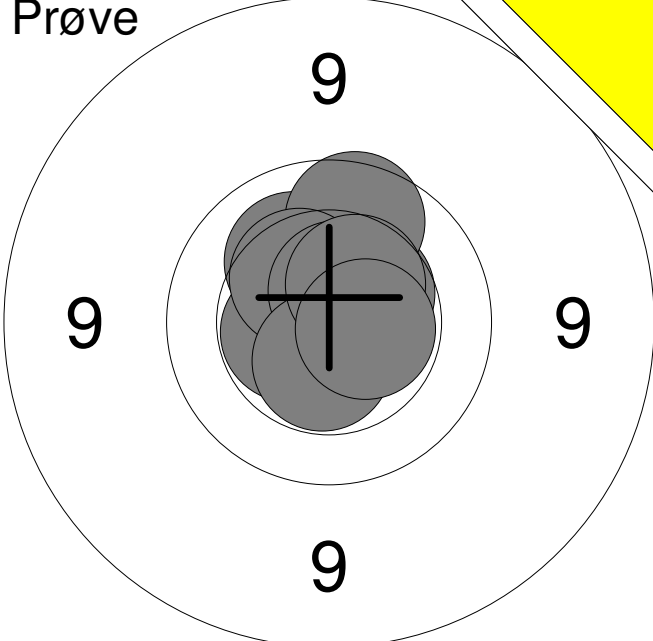
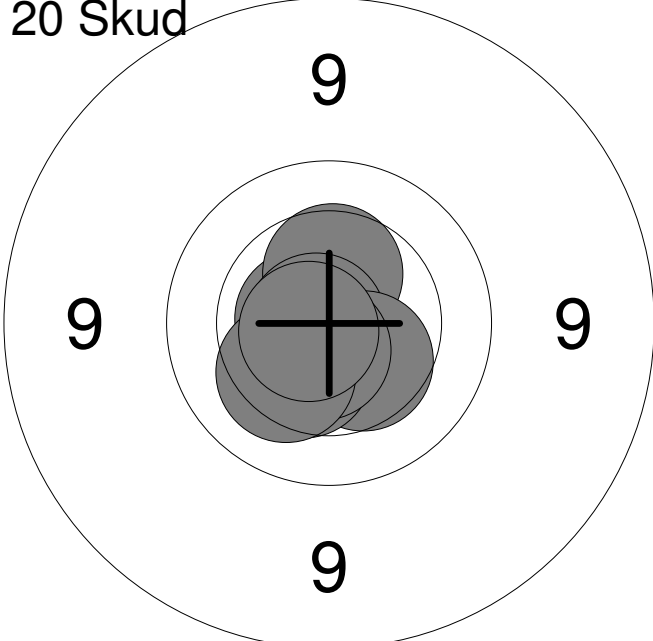
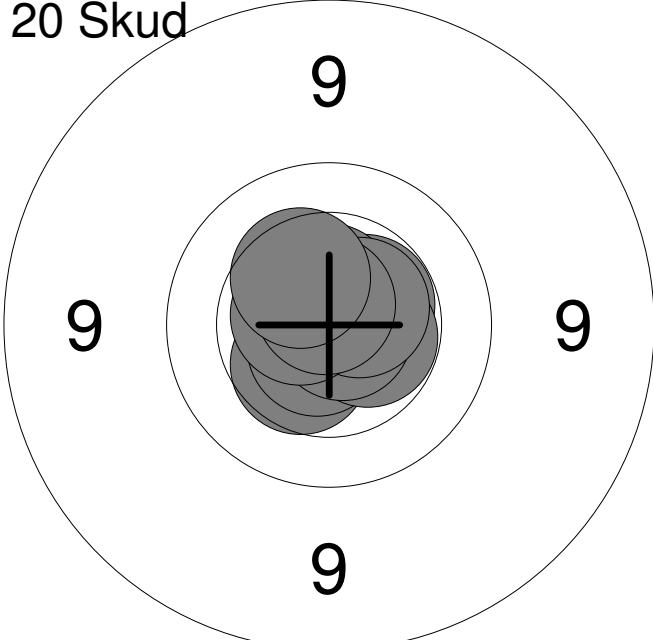
Hold	Skive		
16	2	Mads Lyng	
15m	Vester Hassing Skf.	MB1	
30.01.2015	Nordjysk mesterskab 2015	Aalborg Skyttekreds	
Prøve		1: 10.5	↗
		2: 10.2	↖
		3: 9.9	↑
		4: 10.5x	←
		5: 10.4	↖
		6: 10.6x	↑
		7: 10.5x	↓
		8: 10.4	↗
		9: 10.6x	→
		Serie	
Total		0.0	
20 Skud		1: 10.6x	↖
		2: 10.7x	←
		3: 10.4	↑
		4: 10.8x	←
		5: 10.6x	↖
		6: 10.4	↘
		7: 10.4	↖
		8: 10.6x	↓
		9: 10.2	↖
		10: 10.7x	←
Serie		100.0	
Total		100.0	
20 Skud		11: 10.4	↖
		12: 10.5x	↗
		13: 10.7x	↖
		14: 10.5x	→
		15: 10.6x	↑
		16: 10.8x	→
		17: 10.6x	↗
		18: 10.6x	←
		19: 10.7x	↑
		20: 10.4	↖
Serie		100.0	
Total		200.0	



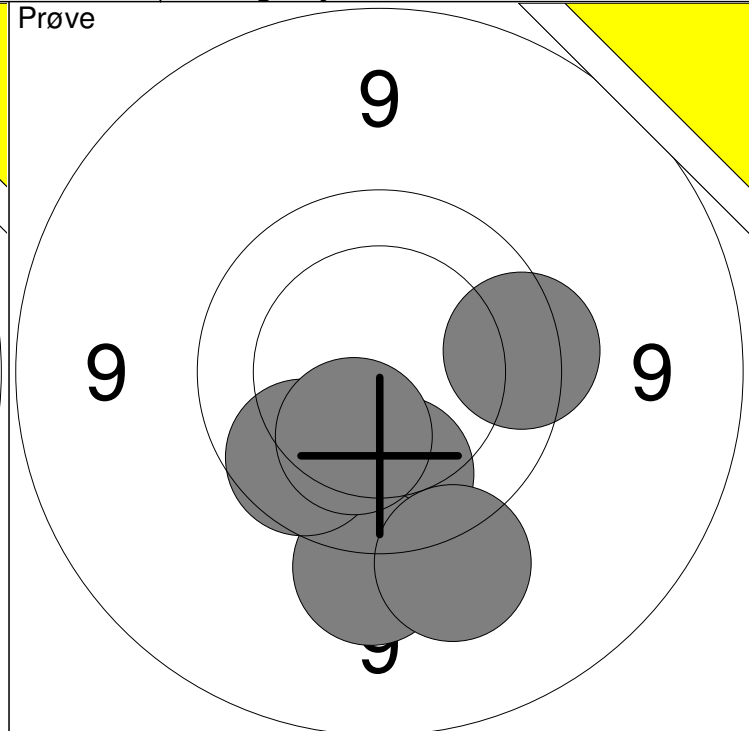
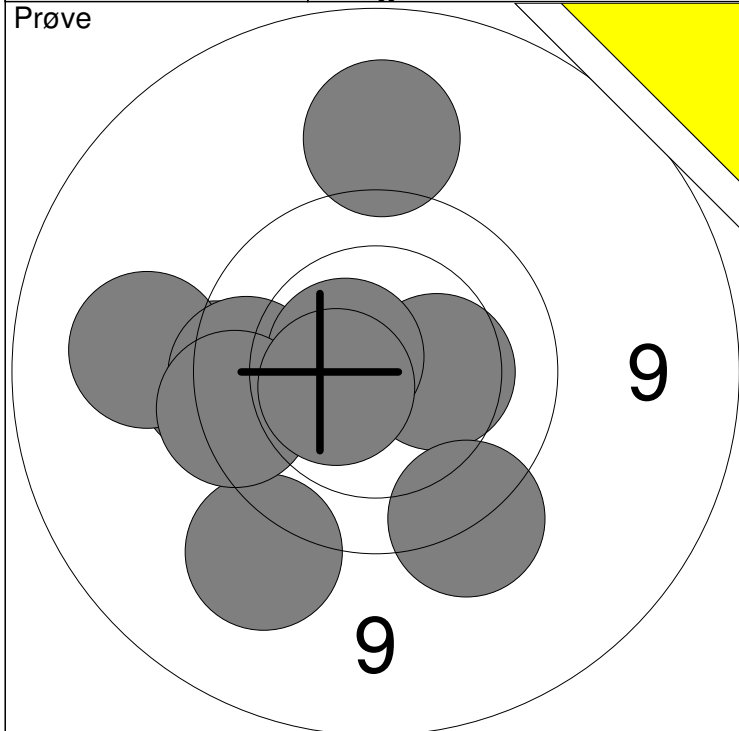

1: 9.6 ←	6: 10.6x ↖	Serie 93
2: 9.3 ←	7: 9.6 ↘	
3: 9.8 ←	8: 9.7 ←	Total 0
4: 9.4 ↙	9: 10.5x ←	
5: 10.4 →	10: 9.2 ↑	

11: 10.0 ↓	16: 9.4 ↓	Serie 56
12: 9.4 ↓		
13: 9.7 →		Total 0
14: 9.9 ↙		
15: 10.3 ↘		

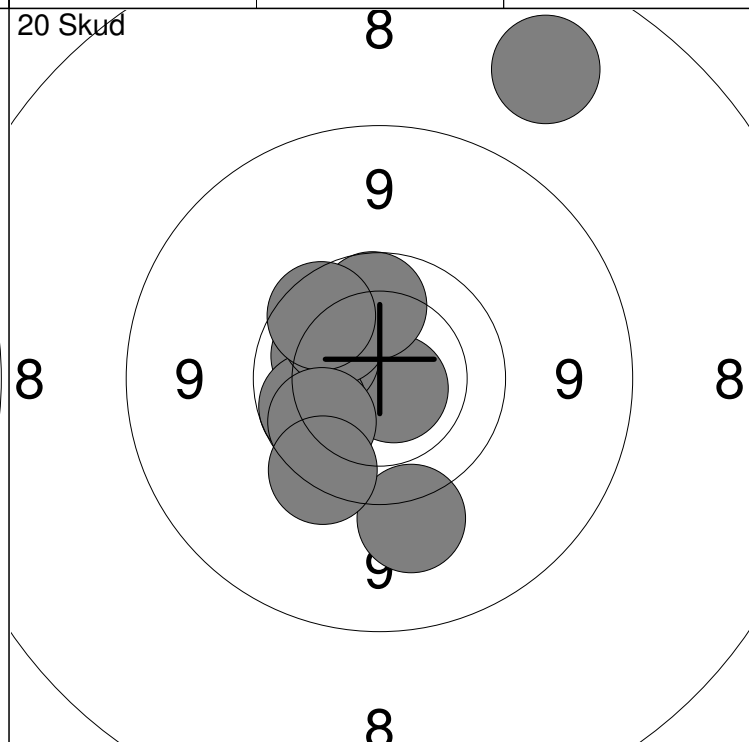
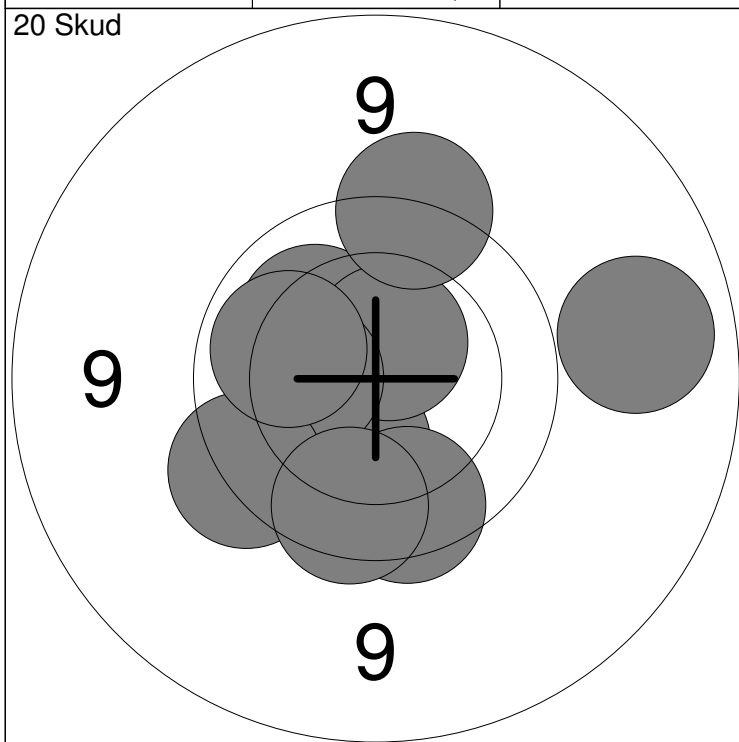

1: 10.2 ↖	6: 9.6 ↑	Serie 95
2: 10.3 ↘	7: 9.1 →	
3: 10.6x ↗	8: 10.1 ←	Total 95
4: 10.3 ←	9: 9.8 ↘	
5: 9.7 ↙	10: 9.8 ↘	

11: 8.2 ↗	16: 9.9 ↑	Serie 93
12: 10.7x ↘	17: 9.8 ↖	
13: 10.1 ←	18: 10.0 ↙	Total 188
14: 9.9 ↙	19: 9.4 ↘	
15: 10.0 ↖	20: 9.7 ↘	

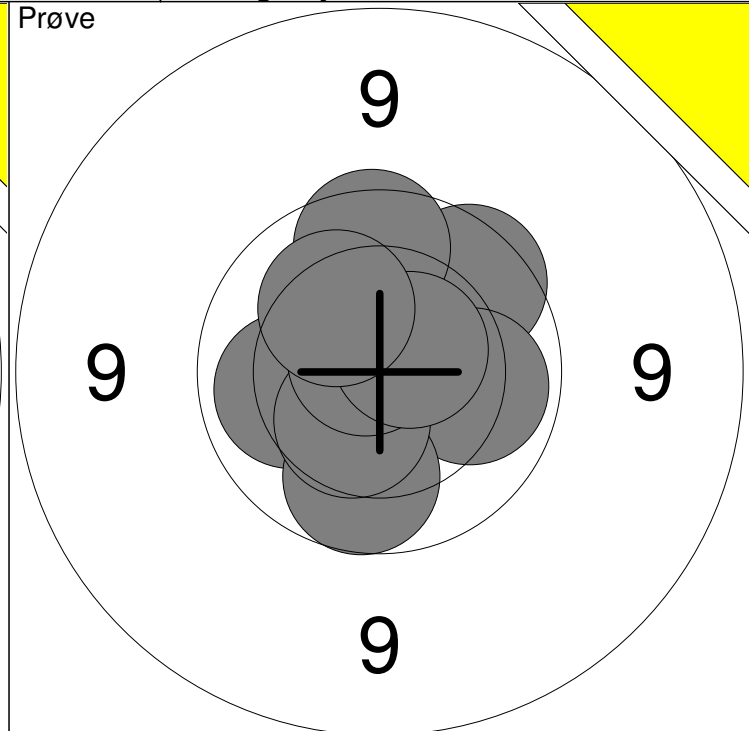
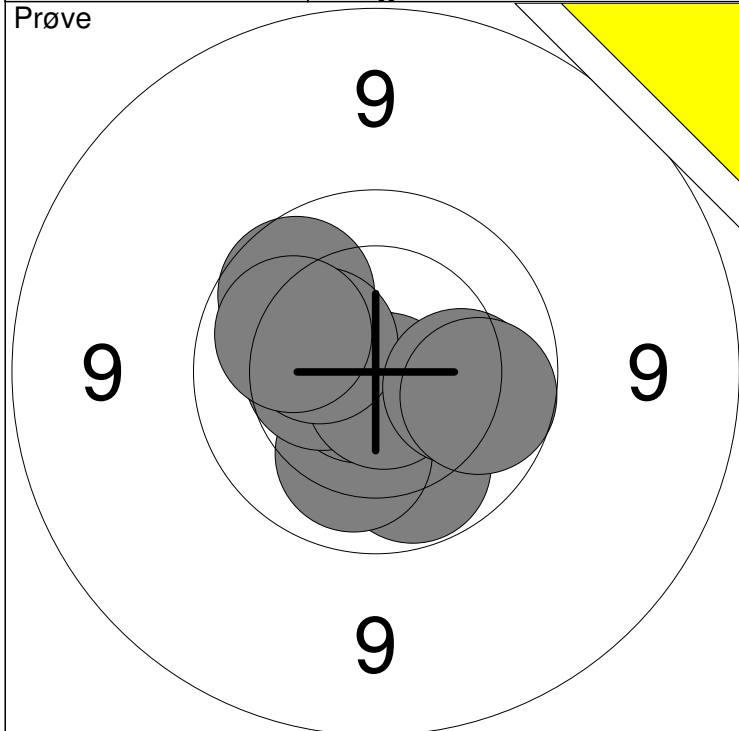

1: 10.0 ↓	6: 10.7x ↓	Serie	98
2: 9.9 ↗	7: 10.4 ↗		
3: 10.1 ↓	8: 10.1 →	Total	0
4: 10.8x ↙	9: 9.9 →		
5: 10.4 ←	10: 10.1 ↗		

11: 9.8 ↗	16: 9.8 ↑	Serie	87
12: 10.1 →	17: 10.8x ↗		
13: 10.1 ←	18: 10.6x ↗	Total	0
14: 9.9 ↓	19: 10.2 ↗		
15: 10.4 ↙			

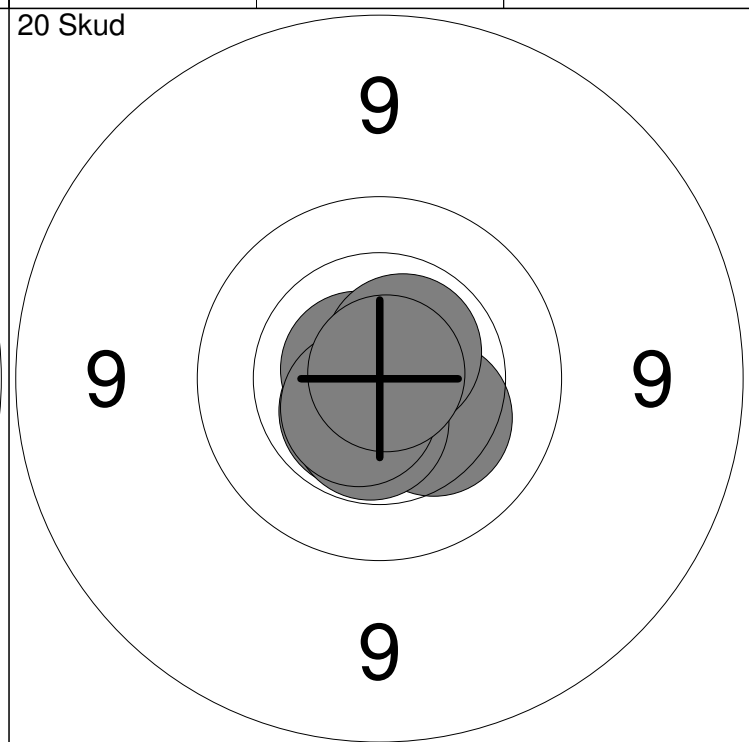
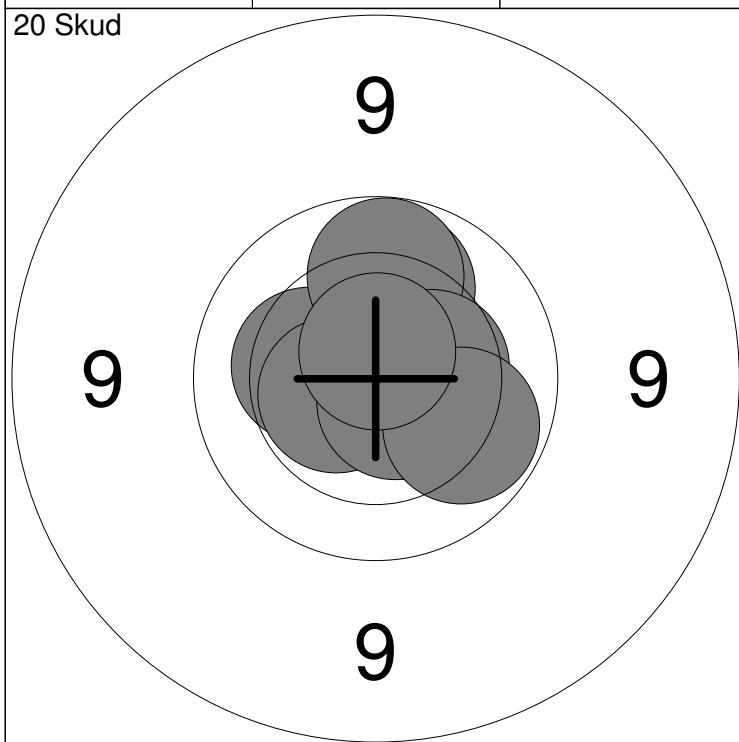

1: 10.1 ↑	6: 10.6x ↓	Serie	100
2: 10.8x ↙	7: 10.4 →		
3: 10.3 ←	8: 10.7x ↓	Total	100
4: 10.0 ↑	9: 10.0 →		
5: 10.5x ↙	10: 10.7x ↑		

11: 10.8x ↗	16: 10.7x ↙	Serie	100
12: 10.9x ↙	17: 10.5x ↓		
13: 10.6x →	18: 10.6x ↗	Total	200
14: 10.6x ↙	19: 10.6x ↙		
15: 10.3 ↙	20: 10.9x ↗		

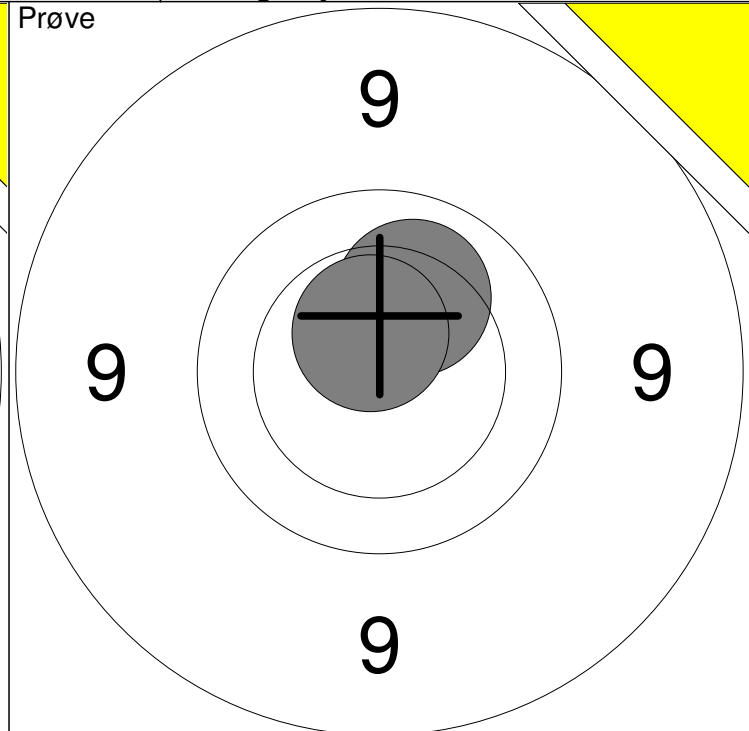
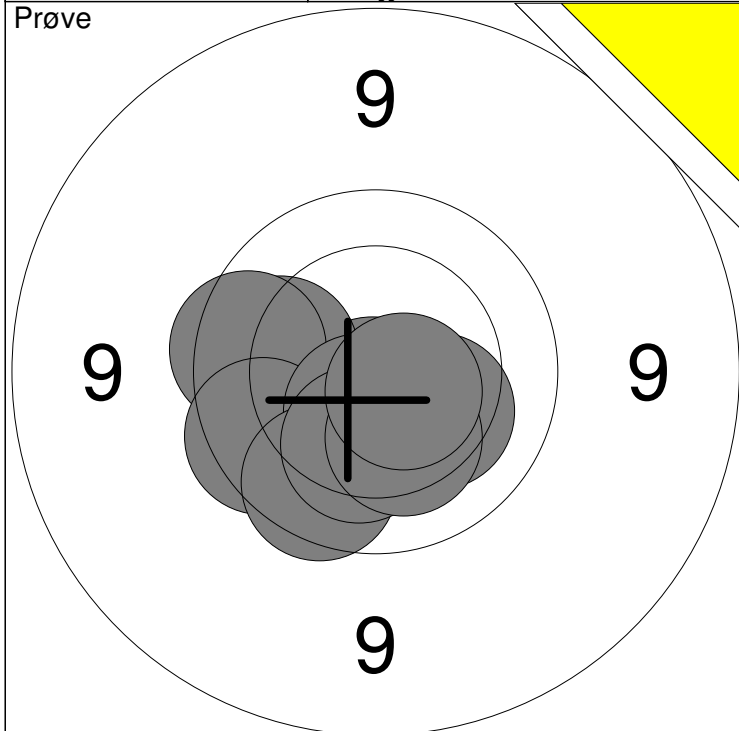

1: 10.7x ↓	6: 10.5x ↓	Serie	97
2: 10.0 ←	7: 9.8 ↓		
3: 9.8 ←	8: 10.2 ↓	Total	0
4: 9.8 ↙	9: 10.3 ↓		
5: 10.3 ↘	10: 10.6x ↘		

11: 10.2 ↗	Serie	20
12: 10.6x ↗		
Total		0

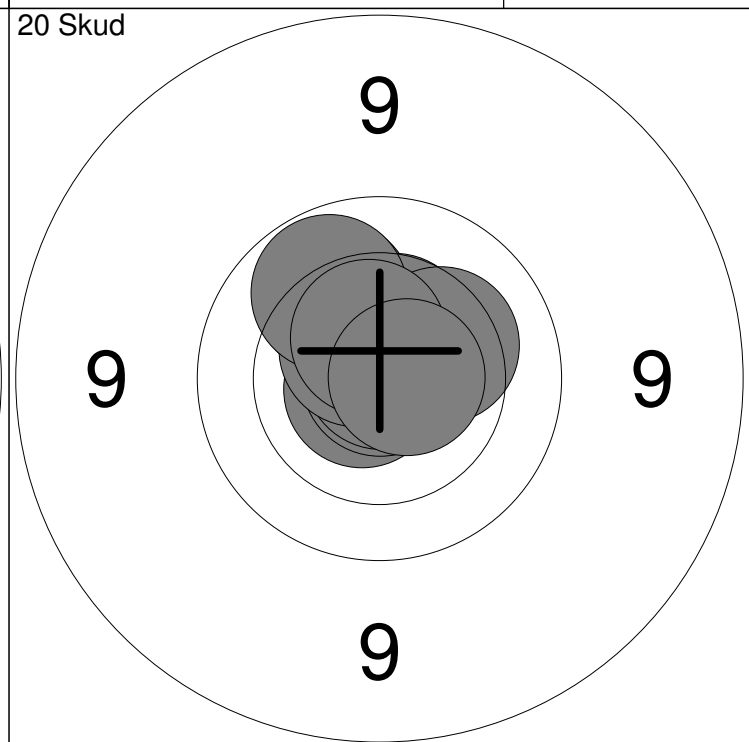
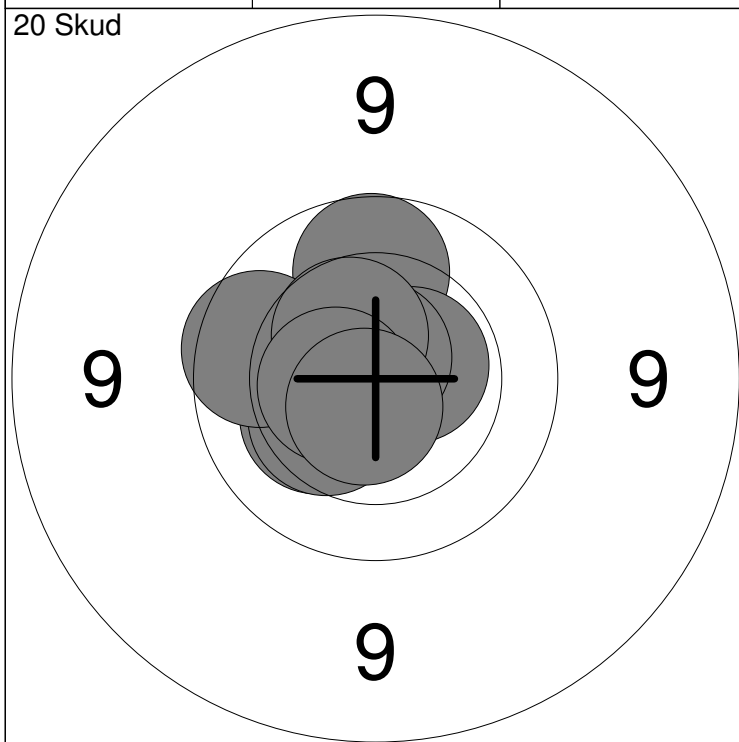

1: 10.3 ↑	6: 9.9 ←	Serie	98
2: 9.9 ↑	7: 10.7x ↑		
3: 10.6x →	8: 10.5 ↗	Total	98
4: 10.3 ↙	9: 10.6x ←		
5: 10.3 ↙	10: 10.7x ↓		

11: 10.8x ↙	16: 10.9x ↗	Serie	100
12: 10.1 ↗	17: 10.6x ↗		
13: 10.5 ↑	18: 10.0 ↗	Total	198
14: 10.9x ↗	19: 10.5x ↑		
15: 10.3 ↗	20: 10.7x →		

Hold <b>16</b>	Skive <b>6</b>	<b>Simon Pedersen</b>	
-------------------	-------------------	-----------------------	--

15m	Løgstør Sportsskytteklub	J2
-----	--------------------------	----

30.01.2015	Nordjysk mesterskab 2015	Aalborg Skyttekreds
------------	--------------------------	---------------------

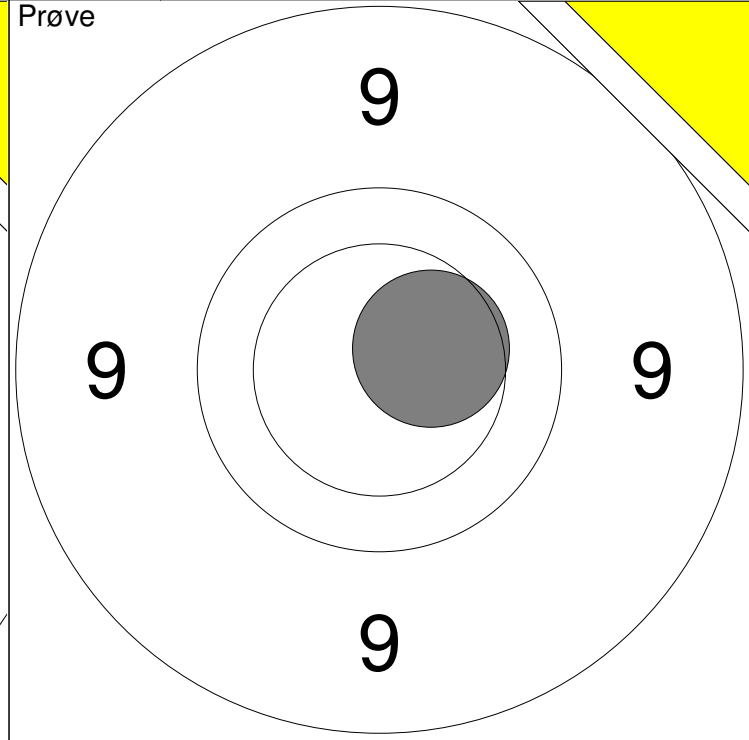
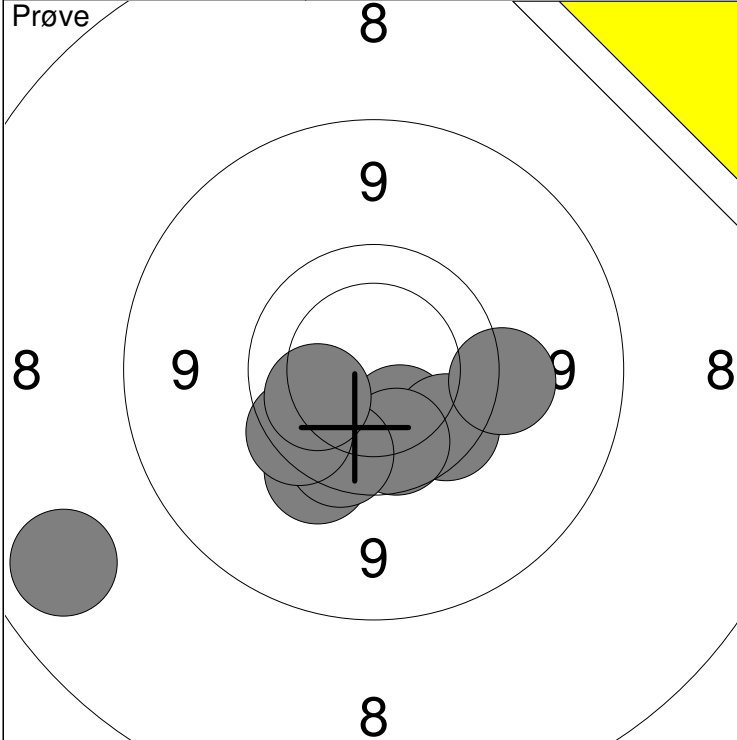

1: 8.1 ↙	6: 9.6 ↓	Serie	92
2: 10.1 ↓	7: 9.8 ↓		
3: 10.2 ↓	8: 9.7 ↙	Total	0
4: 9.8 ↓	9: 9.5 →		
5: 9.9 ↓	10: 10.1 ↙		

11: 10.4 →	Serie	10
	Total	0

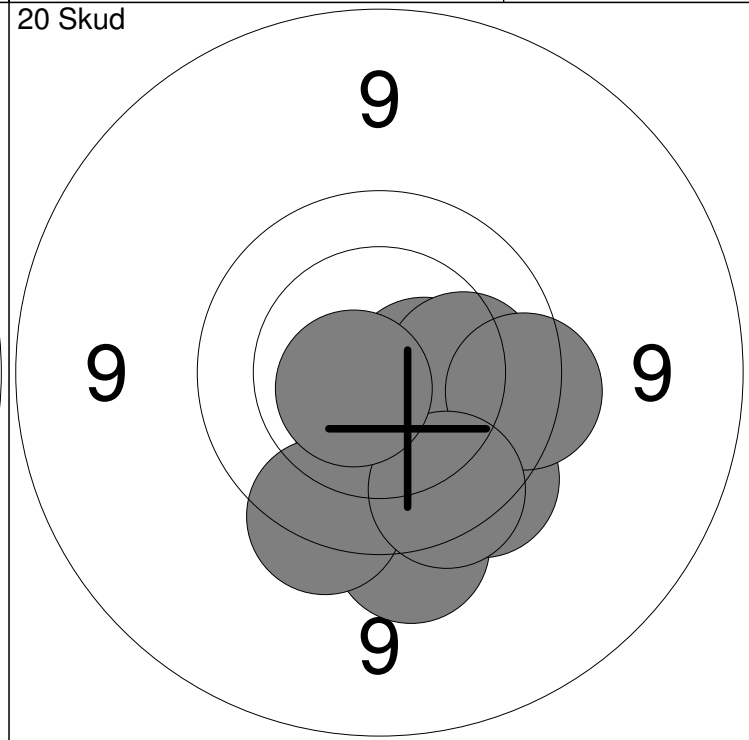
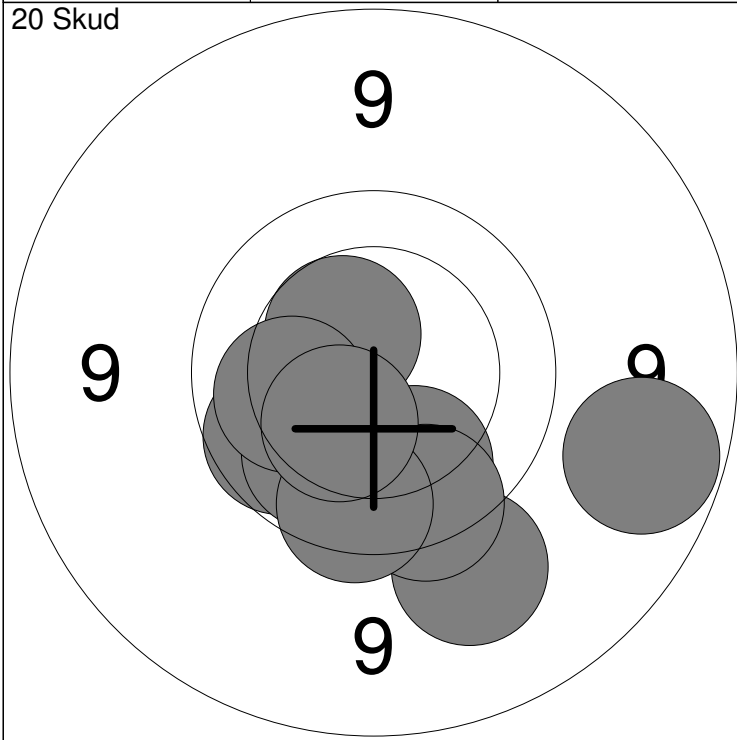

1: 9.3 ↓	6: 10.0 ↓	Serie	95
2: 9.9 ↙	7: 9.8 ↓		
3: 10.5 ↗	8: 9.8 ↓	Total	95
4: 10.0 ↓	9: 9.0 →		
5: 10.1 ↙	10: 10.4 ↓		

11: 9.6 ↓	16: 9.7 ↓	Serie	95
12: 10.4 ↓	17: 10.1 →		
13: 10.4 ↓	18: 9.7 →	Total	190
14: 10.5x →	19: 9.8 ↓		
15: 9.7 ↓	20: 10.7x ↙		

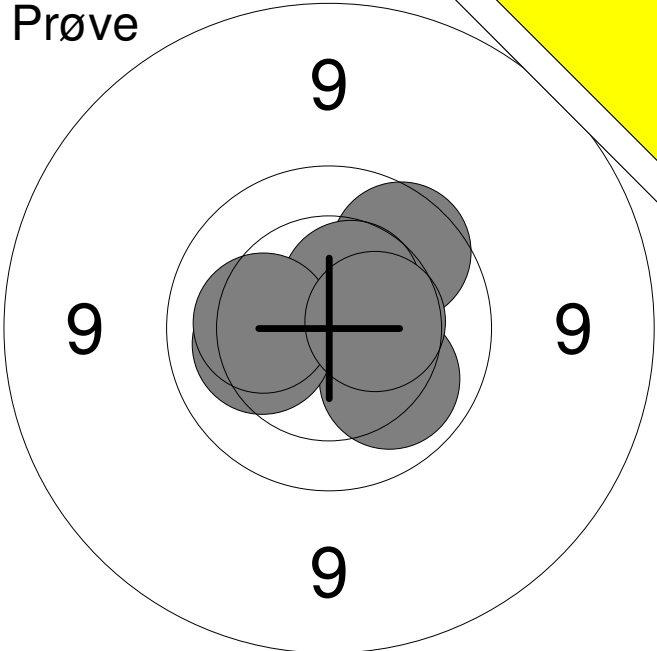
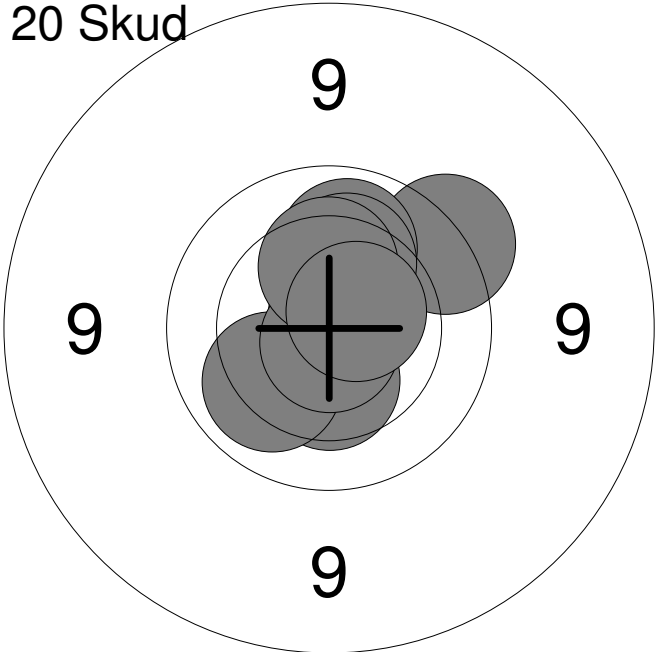
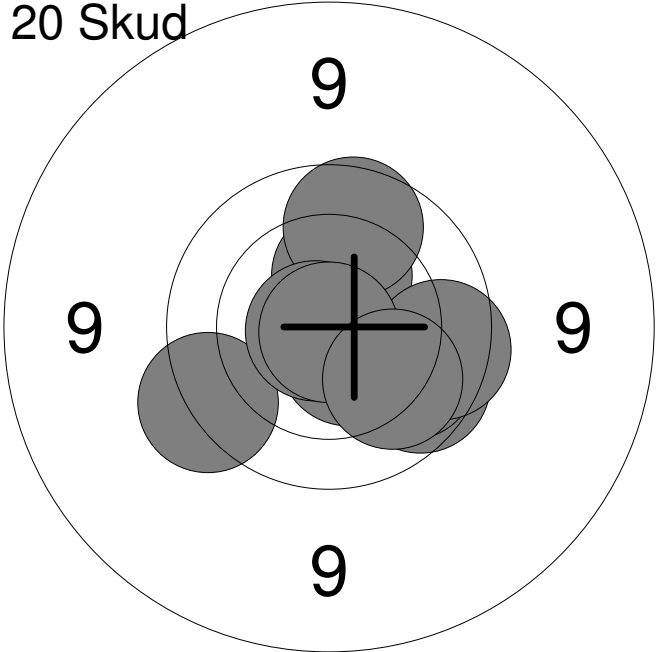
Hold	Skive	Frederik B. Sørensen	
16	7	Løgstør Sportsskytteklub	J1
15m			
30.01.2015	Nordjysk mesterskab 2015	Aalborg Skyttekreds	
Prøve		1: 10.1 ↘	
		2: 9.9 ↗	
		3: 10.2 ←	
		4: 10.5 ↗	
		5: 10.2 ←	
		6: 10.5 →	
		<b>Serie</b> 59.0	
		<b>Total</b> 0.0	
20 Skud		1: 10.4 ↓	
		2: 10.1 ↙	
		3: 10.8x ↗	
		4: 10.7x ↗	
		5: 9.6 ↗	
		6: 10.8x ↓	
		7: 10.1 ↑	
		8: 10.2 ↑	
		9: 10.3 ↑	
		10: 10.6x ↗	
		<b>Serie</b> 99.0	
		<b>Total</b> 99.0	
20 Skud		11: 9.9 ↘	
		12: 10.0 ↘	
		13: 10.4 ↑	
		14: 9.9 ↑	
		15: 10.6x ↓	
		16: 9.8 →	
		17: 9.6 ↙	
		18: 10.8x ←	
		19: 10.9x ↓	
		20: 10.1 ↘	
		<b>Serie</b> 96.0	
		<b>Total</b> 195.0	

Hold <b>16</b>	Skive <b>8</b>	<b>Marcus Stidsborg</b>	
15m	Sæby og Omegns Skytteforening	MB2	
30.01.2015	Nordjysk mesterskab 2015	Aalborg Skyttekreds	
Prøve		1: 9.9	←
		2: 10.1	←
		3: 9.9	↗
		<b>Serie</b>	<b>28.0</b>
		<b>Total</b>	<b>0.0</b>
20 Skud		1: 9.9	↓
		2: 9.4	↗
		3: 9.8	↗
		4: 10.1	↗
		5: 9.8	↖
		6: 10.0	→
		7: 10.1	↗
		8: 9.8	↖
		9: 10.4	↗
		10: 9.9	←
		<b>Serie</b>	<b>94.0</b>
		<b>Total</b>	<b>94.0</b>
20 Skud		11: 10.3	↗
		12: 10.5x	←
		13: 9.9	←
		14: 10.2	←
		15: 8.8	←
		16: 10.1	↗
		17: 9.8	←
		18: 10.4	↗
		19: 8.9	↗
		20: 9.7	←
		<b>Serie</b>	<b>93.0</b>
		<b>Total</b>	<b>187.0</b>

Hold <b>16</b>	Skive <b>9</b>	<b>Emma Hansen</b>	
15m	Vilsted Skf.	MB2	
30.01.2015	Nordjysk mesterskab 2015	Aalborg Skyttekreds	
Prøve		1: 10.2	↓
		2: 10.3	↓
		3: 10.3	↗
		4: 10.4	↓
		5: 10.3	↓
		6: 10.3	↙
		7: 10.8x	↓
		8: 10.8x	↑
		<b>Serie</b>	<b>80.0</b>
		<b>Total</b>	<b>0.0</b>
20 Skud		1: 10.8x	↙
		2: 10.5	↑
		3: 10.6x	↓
		4: 10.1	→
		5: 10.6x	↖
		6: 10.4	→
		7: 10.5x	↘
		8: 10.4	←
		9: 10.5	↑
		10: 10.1	↗
		<b>Serie</b>	<b>100.0</b>
		<b>Total</b>	<b>100.0</b>
20 Skud		11: 10.0	↖
		12: 9.8	↗
		13: 10.4	→
		14: 10.5x	↙
		15: 9.9	↑
		16: 10.4	→
		17: 10.7x	↓
		18: 10.1	↑
		19: 10.6x	↗
		20: 10.8x	↓
		<b>Serie</b>	<b>98.0</b>
		<b>Total</b>	<b>198.0</b>

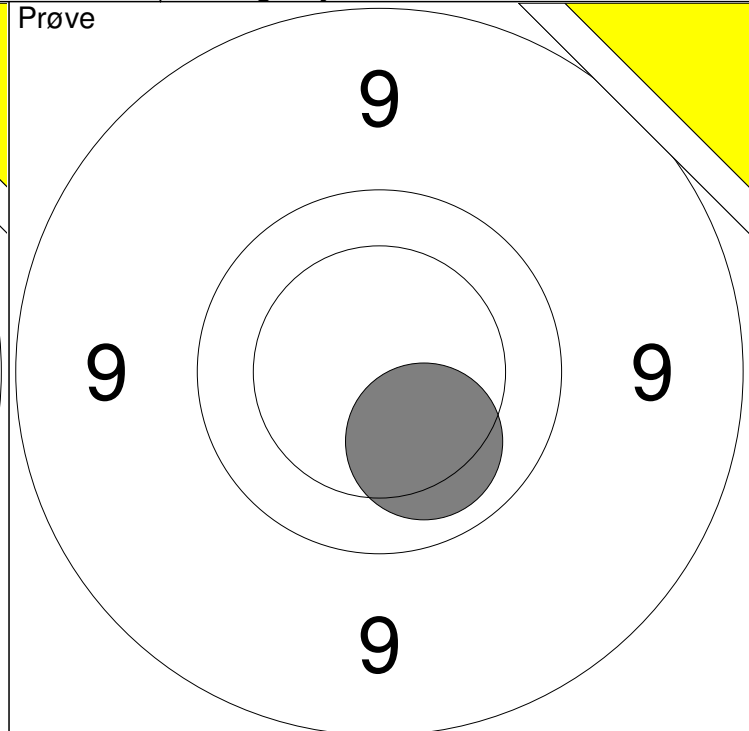
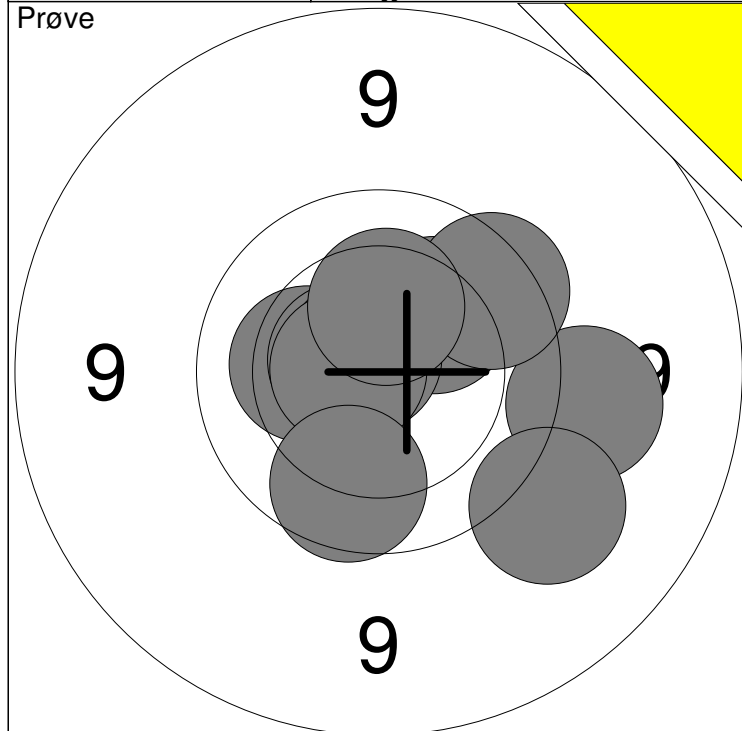

1: 10.3 ←	6: 9.3 ↘	Serie	96
2: 10.6x ↖	7: 9.8 ↗		
3: 9.4 →	8: 10.7x ←	Total	0
4: 10.2 ↗	9: 10.3 ↑		
5: 10.7x ↖	10: 9.9 ↘		

11: 10.2 ↘	Serie	10
	Total	0

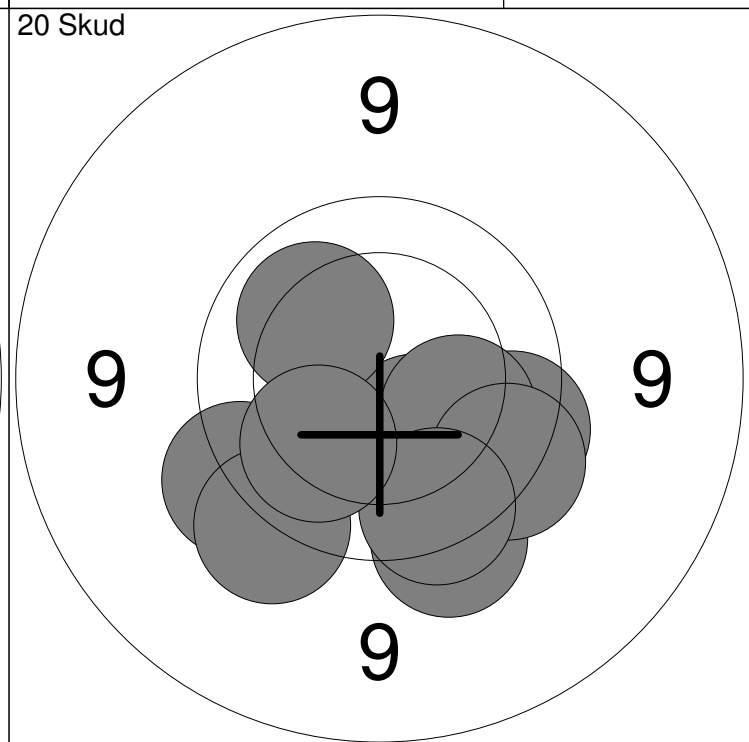
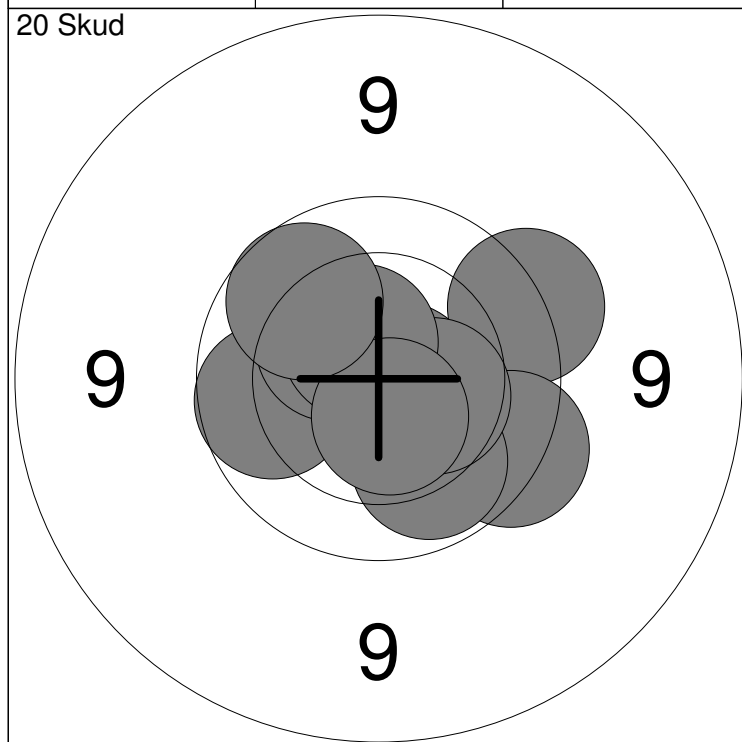

1: 9.9 ←	6: 10.0 ↘	Serie	96
2: 9.6 ↗	7: 10.4 ↘		
3: 10.8x →	8: 10.6x ↗	Total	96
4: 10.4 ↗	9: 10.6x ↘		
5: 9.7 ↘	10: 9.9 ↗		

11: 10.3 ↘	16: 10.1 ↘	Serie	94
12: 9.6 ↘	17: 10.1 ↗		
13: 9.7 →	18: 9.7 ↘	Total	190
14: 9.6 ←	19: 9.7 ↘		
15: 9.5 ↘	20: 10.1 ↘		

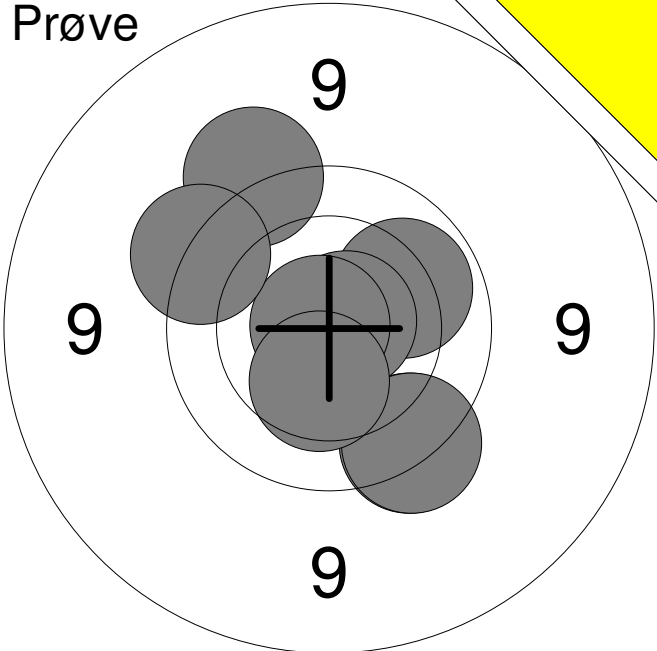
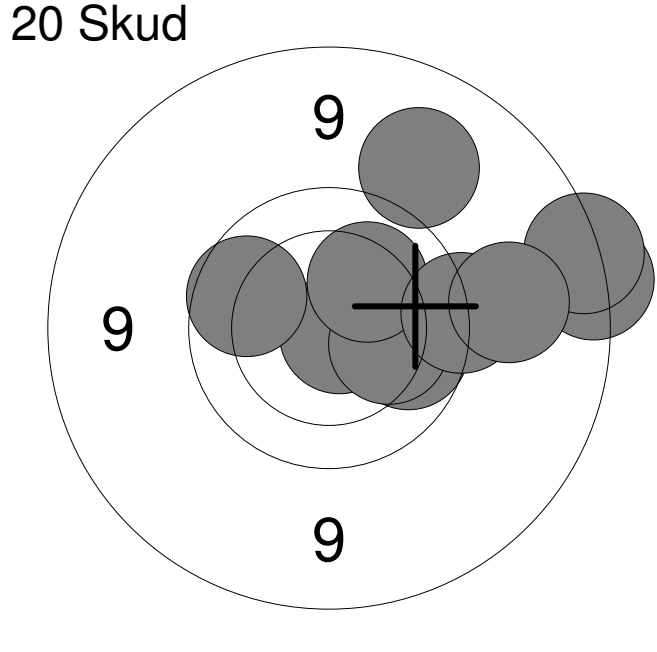
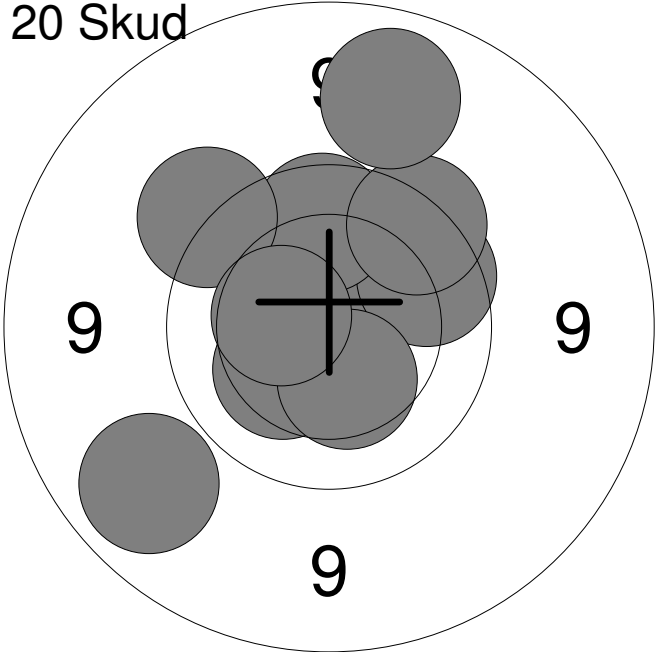

Hold	Skive	Elias Erbs	
16	12	Frederikshavn Skyttekreds	BK4
15m			
30.01.2015	Nordjysk mesterskab 2015	Aalborg Skyttekreds	
Prøve		1: 9.5	↗
		2: 9.7	↘
		3: 10.0	→
		4: 10.8x	→
		5: 9.7	↘
		6: 10.8x	↗
		7: 9.6	↗
		8: 10.4	↘
		<b>Serie</b>	<b>76.0</b>
		<b>Total</b>	<b>0.0</b>
20 Skud		1: 10.8x	↘
		2: 9.9	→
		3: 9.9	↗
		4: 10.2	→
		5: 8.7	→
		6: 10.2	↗
		7: 9.6	→
		8: 9.2	↗
		9: 8.7	→
		10: 9.2	→
		<b>Serie</b>	<b>91.0</b>
		<b>Total</b>	<b>91.0</b>
20 Skud		11: 10.5x	↗
		12: 9.8	→
		13: 9.1	↖
		14: 10.3	↖
		15: 10.4	↘
		16: 9.9	↗
		17: 9.7	↗
		18: 9.5	↗
		19: 9.1	↗
		20: 10.4	↖
		<b>Serie</b>	<b>94.0</b>
		<b>Total</b>	<b>185.0</b>

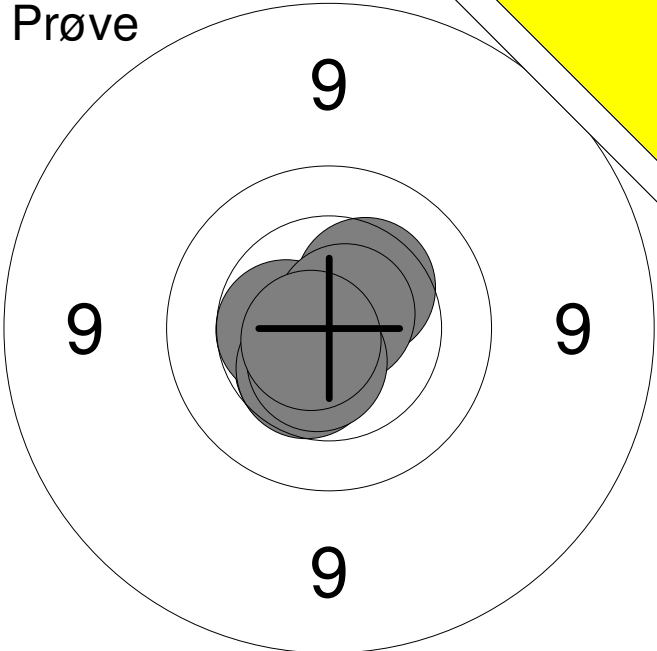
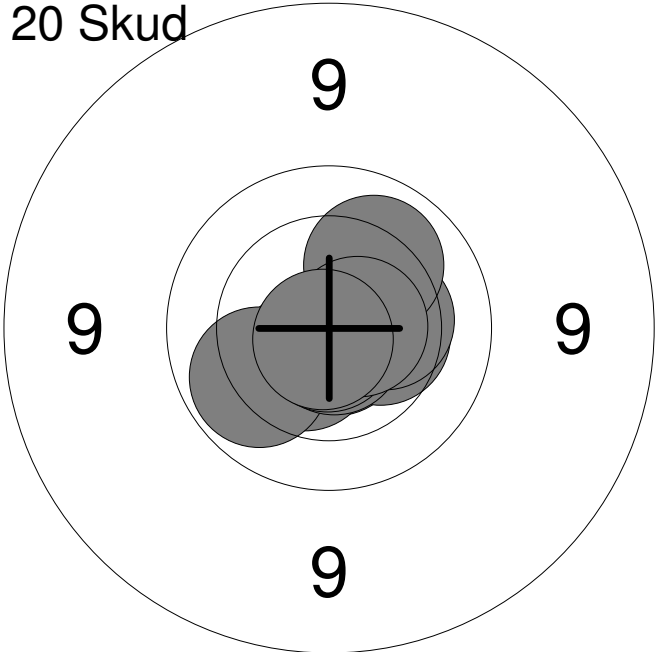
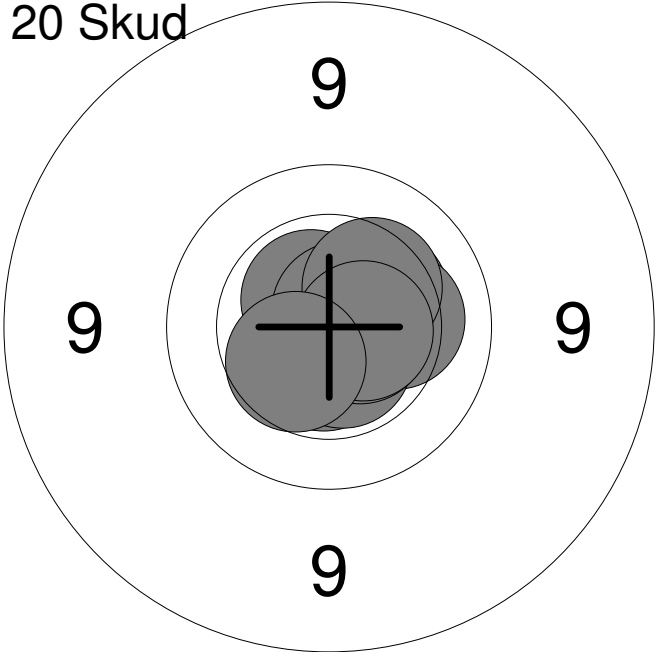
Hold	Skive	Kathrine Jakobsen	
17	1	15m	Vester Hassing Skf. MB1
30.01.2015	Nordjysk mesterskab 2015	Aalborg Skyttekreds	
Prøve		1: 10.5 ↙	
		2: 10.5 ←	
		3: 10.5 ↘	
		4: 10.4 ↗	
		5: 10.7x ↗	
		6: 10.6x ↓	
		7: 10.7x ↙	
		<b>Serie</b>	<b>70.0</b>
		<b>Total</b>	<b>0.0</b>
20 Skud		1: 10.8x ↓	
		2: 10.5x ↘	
		3: 10.0 ↙	
		4: 10.4 →	
		5: 10.3 →	
		6: 10.1 ↗	
		7: 10.8x ↓	
		8: 10.8x ↓	
		9: 10.6x →	
		10: 10.8x ↙	
		<b>Serie</b>	<b>100.0</b>
		<b>Total</b>	<b>100.0</b>
20 Skud		11: 10.3 ↗	
		12: 10.6x ↓	
		13: 10.6x ↗	
		14: 10.2 →	
		15: 10.6x ↓	
		16: 10.7x ↗	
		17: 10.6x →	
		18: 10.3 ↗	
		19: 10.6x →	
		20: 10.4 ↙	
		<b>Serie</b>	<b>100.0</b>
		<b>Total</b>	<b>200.0</b>

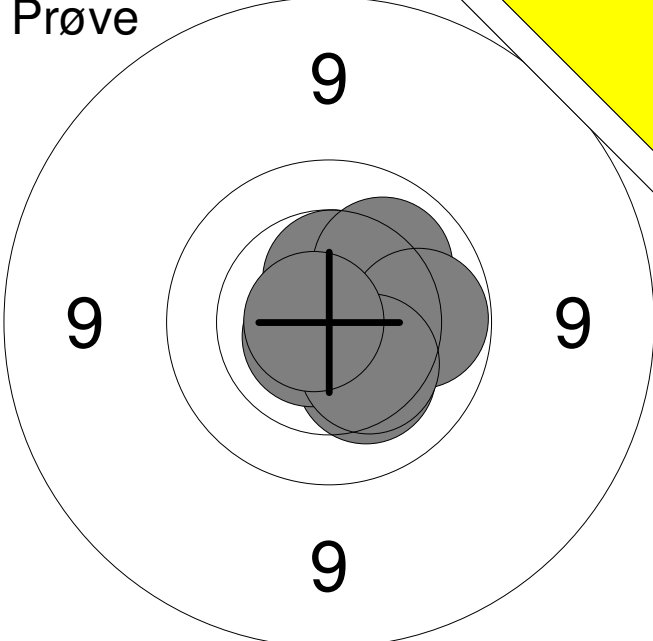
<b>Prøve</b> 	1:	10.8x	←
	2:	10.8x	↗
	3:	10.5x	↑
	4:	10.1	↗
	5:	10.3	↘
	6:	10.7x	↙
	7:	10.0	→
	8:	10.3	↘
	9:	10.8x	←
	<b>Serie</b>		<b>90.0</b>
<b>Total</b>		<b>0.0</b>	

<b>20 Skud</b> 	1:	10.2	↘
	2:	10.4	↙
	3:	10.1	←
	4:	10.4	↙
	5:	10.2	↘
	6:	10.1	→
	7:	10.6x	→
	8:	10.5x	↙
	9:	10.4	↑
	10:	10.6x	↗
<b>Serie</b>		<b>100.0</b>	
<b>Total</b>		<b>100.0</b>	

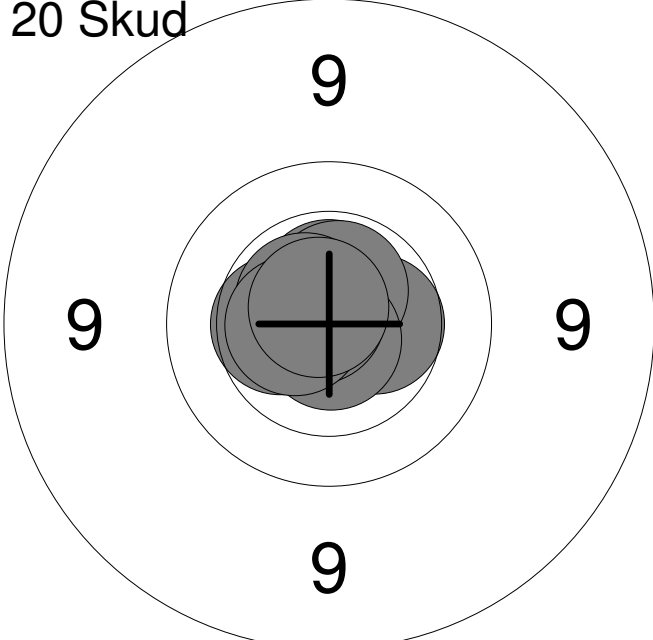
<b>20 Skud</b> 	11:	10.4	←
	12:	10.6x	↑
	13:	10.5	→
	14:	10.7x	↗
	15:	10.6x	↗
	16:	10.6x	↗
	17:	10.8x	↘
	18:	10.8x	↗
	19:	10.6x	←
	20:	10.7x	↗
<b>Serie</b>		<b>100.0</b>	
<b>Total</b>		<b>200.0</b>	

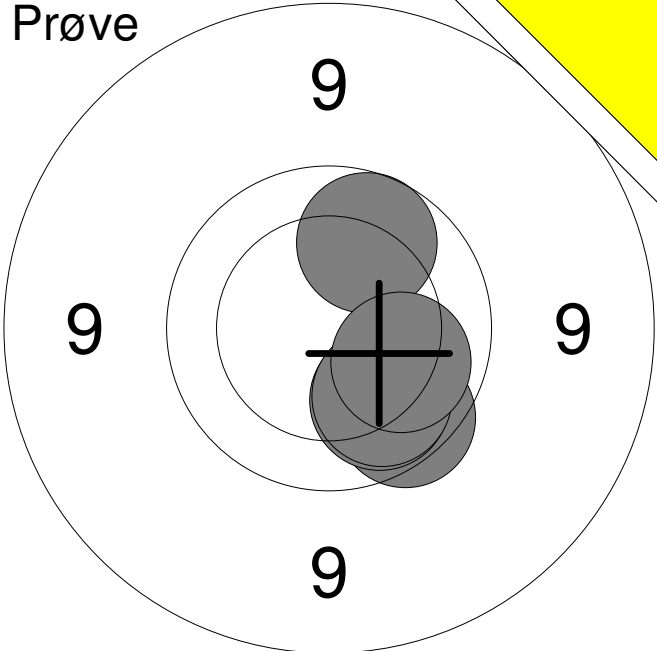
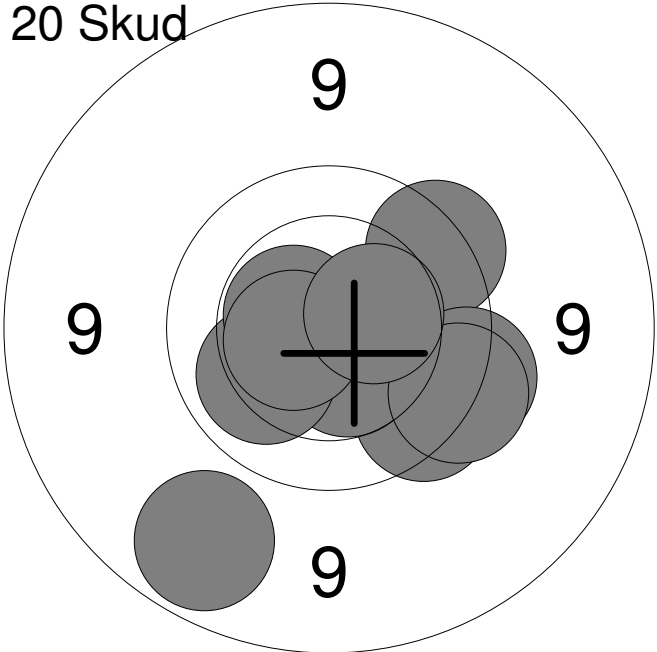
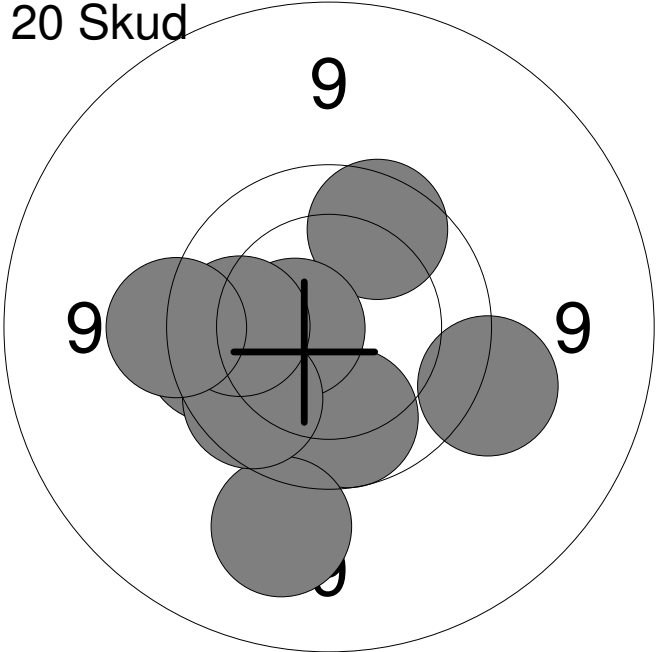
Hold	Skive	Daniel Larsen		
17	3	15m	Vester Hassing Skf.	MB3
30.01.2015	Nordjysk mesterskab 2015	Aalborg Skyttekreds		
Prøve		1: 9.8	↘	
		2: 9.9	↗	
		3: 10.0	↘	
		4: 10.0	↘	
		5: 10.1	↘	
		<b>Serie</b>	<b>48.0</b>	
		<b>Total</b>	<b>0.0</b>	
20 Skud		1: 9.0	↘	
		2: 9.7	↗	
		3: 9.7	↘	
		4: 9.6	↗	
		5: 10.5	↘	
		6: 9.6	↘	
		7: 10.1	↖	
		8: 10.5x	↖	
		9: 10.5x	↖	
		10: 10.4	↗	
		<b>Serie</b>	<b>95.0</b>	
		<b>Total</b>	<b>95.0</b>	
20 Skud		11: 9.9	↘	
		12: 9.9	↗	
		13: 9.9	↘	
		14: 10.6x	↖	
		15: 9.3	↘	
		16: 9.8	↖	
		17: 9.9	↖	
		18: 10.0	↖	
		19: 9.6	↖	
		20: 9.5	↗	
		<b>Serie</b>	<b>92.0</b>	
		<b>Total</b>	<b>187.0</b>	

Hold <b>17</b>	Skive <b>4</b>	<b>Morten Bols Pedersen</b>	
-------------------	-------------------	-----------------------------	--

15m	Vester Hassing Skf.	MB4	
-----	---------------------	-----	--

30.01.2015	Nordjysk mesterskab 2015	Aalborg Skyttekreds	
------------	--------------------------	---------------------	--

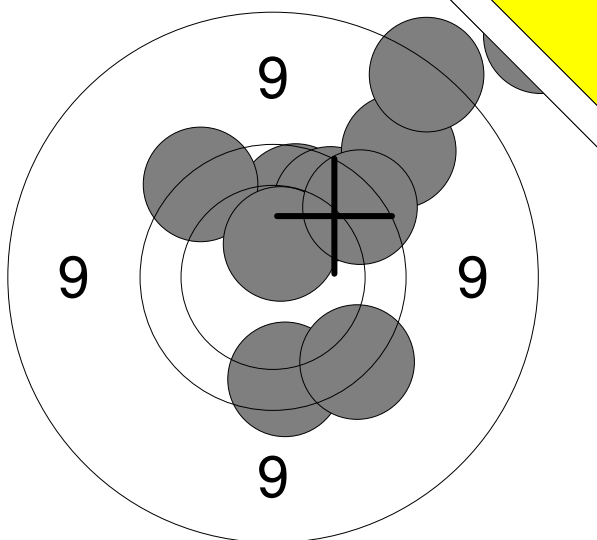
<b>Prøve</b> 	1:	9.9	↑
	2:	9.8	↗
	3:	9.2	↗
	4:	9.6	↖
	5:	9.7	↓
	6:	10.5x	↑
	7:	9.7	↗
	8:	8.7	↗
	9:	8.2	↗
	10:	9.6	↓
	<b>Serie</b>		<b>89.0</b>
<b>Total</b>		<b>0.0</b>	

<b>20 Skud</b> 	1:	9.9	⇒
	2:	9.1	←
	3:	9.8	↑
	4:	9.4	→
	5:	8.7	↗
	6:	9.8	↗
	7:	9.9	↖
	8:	10.8x	←
	9:	9.5	→
	10:	9.8	↗
	<b>Serie</b>		<b>90.0</b>
<b>Total</b>		<b>90.0</b>	

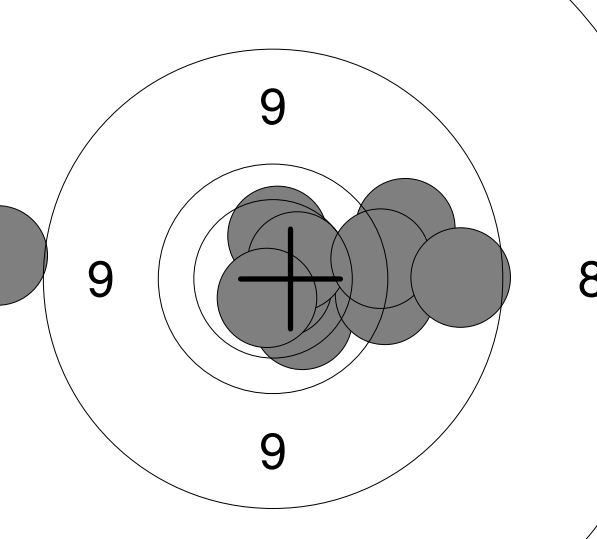
<b>20 Skud</b> 	11:	10.2	↓
	12:	9.5	→
	13:	10.8x	↓
	14:	10.3	↑
	15:	9.3	→
	16:	8.4	←
	17:	10.5	↗
	18:	10.7x	↓
	19:	9.6	→
	20:	8.9	→
	<b>Serie</b>		<b>93.0</b>
<b>Total</b>		<b>183.0</b>	

<p><b>Prøve</b></p>	<table style="width:100%; border-collapse: collapse;"> <tr><td style="width:10%;">1:</td><td style="width:70%;">10.3</td><td style="width:20%; text-align: right;">↘</td></tr> <tr><td>2:</td><td>10.5x</td><td style="text-align: right;">↘</td></tr> <tr><td>3:</td><td>10.4</td><td style="text-align: right;">↘</td></tr> <tr><td>4:</td><td>10.5x</td><td style="text-align: right;">↘</td></tr> <tr><td>5:</td><td>9.5</td><td style="text-align: right;">↘</td></tr> <tr><td>6:</td><td>10.5x</td><td style="text-align: right;">→</td></tr> </table>	1:	10.3	↘	2:	10.5x	↘	3:	10.4	↘	4:	10.5x	↘	5:	9.5	↘	6:	10.5x	→
1:	10.3	↘																	
2:	10.5x	↘																	
3:	10.4	↘																	
4:	10.5x	↘																	
5:	9.5	↘																	
6:	10.5x	→																	
<table style="width:100%; border-collapse: collapse;"> <tr> <td style="width:10%;"><b>Serie</b></td> <td style="width:70%;"></td> <td style="width:20%; text-align: right;"><b>59.0</b></td> </tr> <tr> <td><b>Total</b></td> <td></td> <td style="text-align: right;"><b>0.0</b></td> </tr> </table>		<b>Serie</b>		<b>59.0</b>	<b>Total</b>		<b>0.0</b>												
<b>Serie</b>		<b>59.0</b>																	
<b>Total</b>		<b>0.0</b>																	

<p><b>20 Skud</b></p>	<table style="width:100%; border-collapse: collapse;"> <tr><td style="width:10%;">1:</td><td style="width:70%;">9.8</td><td style="width:20%; text-align: right;">→</td></tr> <tr><td>2:</td><td>10.2</td><td style="text-align: right;">→</td></tr> <tr><td>3:</td><td>9.9</td><td style="text-align: right;">↘</td></tr> <tr><td>4:</td><td>9.8</td><td style="text-align: right;">→</td></tr> <tr><td>5:</td><td>10.4</td><td style="text-align: right;">↘</td></tr> <tr><td>6:</td><td>10.4</td><td style="text-align: right;">↘</td></tr> <tr><td>7:</td><td>10.2</td><td style="text-align: right;">↘</td></tr> <tr><td>8:</td><td>10.5x</td><td style="text-align: right;">↘</td></tr> <tr><td>9:</td><td>10.6x</td><td style="text-align: right;">↘</td></tr> <tr><td>10:</td><td>10.3</td><td style="text-align: right;">↗</td></tr> </table>	1:	9.8	→	2:	10.2	→	3:	9.9	↘	4:	9.8	→	5:	10.4	↘	6:	10.4	↘	7:	10.2	↘	8:	10.5x	↘	9:	10.6x	↘	10:	10.3	↗
1:	9.8	→																													
2:	10.2	→																													
3:	9.9	↘																													
4:	9.8	→																													
5:	10.4	↘																													
6:	10.4	↘																													
7:	10.2	↘																													
8:	10.5x	↘																													
9:	10.6x	↘																													
10:	10.3	↗																													
<table style="width:100%; border-collapse: collapse;"> <tr> <td style="width:10%;"><b>Serie</b></td> <td style="width:70%;"></td> <td style="width:20%; text-align: right;"><b>97.0</b></td> </tr> <tr> <td><b>Total</b></td> <td></td> <td style="text-align: right;"><b>97.0</b></td> </tr> </table>		<b>Serie</b>		<b>97.0</b>	<b>Total</b>		<b>97.0</b>																								
<b>Serie</b>		<b>97.0</b>																													
<b>Total</b>		<b>97.0</b>																													

<p><b>20 Skud</b></p>	<table style="width:100%; border-collapse: collapse;"> <tr><td style="width:10%;">11:</td><td style="width:70%;">10.0</td><td style="width:20%; text-align: right;">→</td></tr> <tr><td>12:</td><td>9.6</td><td style="text-align: right;">↘</td></tr> <tr><td>13:</td><td>9.5</td><td style="text-align: right;">↘</td></tr> <tr><td>14:</td><td>9.9</td><td style="text-align: right;">↘</td></tr> <tr><td>15:</td><td>10.2</td><td style="text-align: right;">→</td></tr> <tr><td>16:</td><td>9.5</td><td style="text-align: right;">↘</td></tr> <tr><td>17:</td><td>10.6x</td><td style="text-align: right;">↗</td></tr> <tr><td>18:</td><td>10.3</td><td style="text-align: right;">↘</td></tr> <tr><td>19:</td><td>9.8</td><td style="text-align: right;">↗</td></tr> <tr><td>20:</td><td>10.0</td><td style="text-align: right;">↘</td></tr> </table>	11:	10.0	→	12:	9.6	↘	13:	9.5	↘	14:	9.9	↘	15:	10.2	→	16:	9.5	↘	17:	10.6x	↗	18:	10.3	↘	19:	9.8	↗	20:	10.0	↘
11:	10.0	→																													
12:	9.6	↘																													
13:	9.5	↘																													
14:	9.9	↘																													
15:	10.2	→																													
16:	9.5	↘																													
17:	10.6x	↗																													
18:	10.3	↘																													
19:	9.8	↗																													
20:	10.0	↘																													
<table style="width:100%; border-collapse: collapse;"> <tr> <td style="width:10%;"><b>Serie</b></td> <td style="width:70%;"></td> <td style="width:20%; text-align: right;"><b>95.0</b></td> </tr> <tr> <td><b>Total</b></td> <td></td> <td style="text-align: right;"><b>192.0</b></td> </tr> </table>		<b>Serie</b>		<b>95.0</b>	<b>Total</b>		<b>192.0</b>																								
<b>Serie</b>		<b>95.0</b>																													
<b>Total</b>		<b>192.0</b>																													

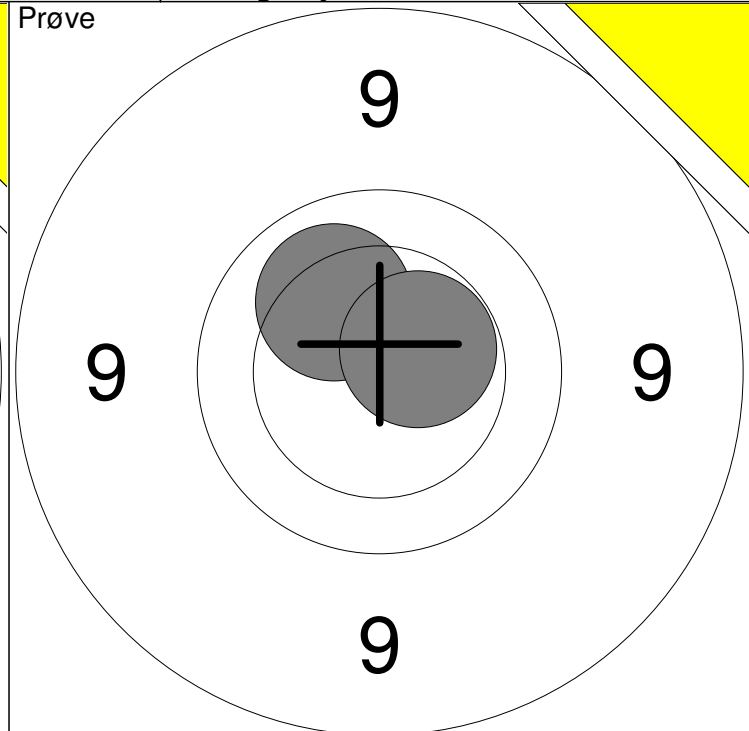
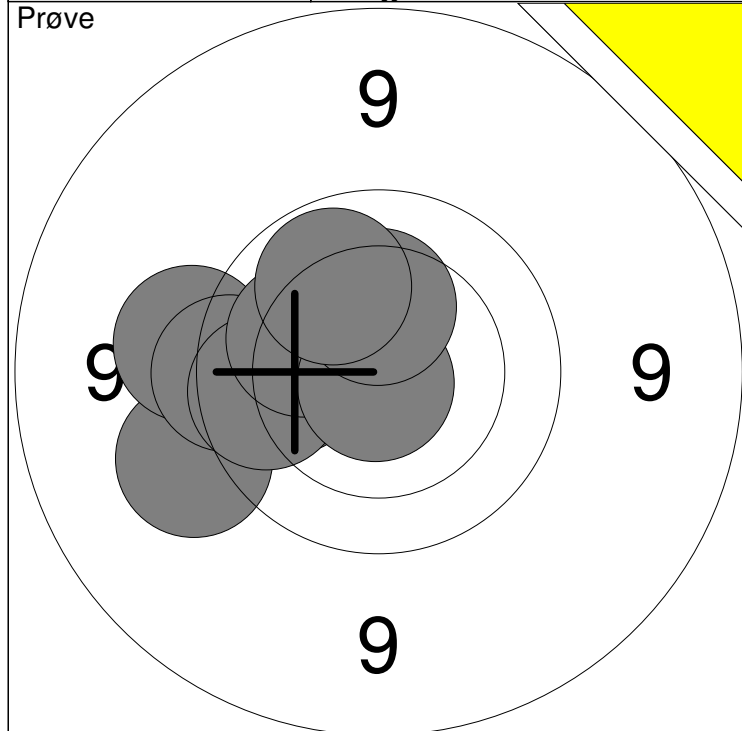

1: 9.4 ←	6: 10.8x ↖	Serie	96
2: 9.5 ←	7: 10.2 ↖		
3: 9.7 ←	8: 10.8x ↓	Total	0
4: 10.1 ←	9: 10.3 ↑		
5: 9.9 ←	10: 10.0 ↗		

11: 10.1 ↖	Serie	20
12: 10.5x ↗		
Total		0

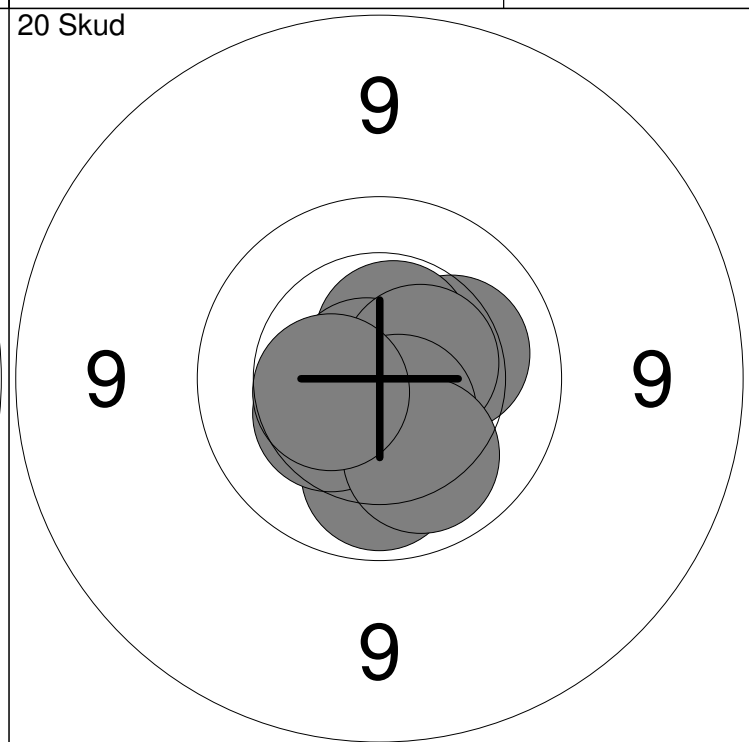
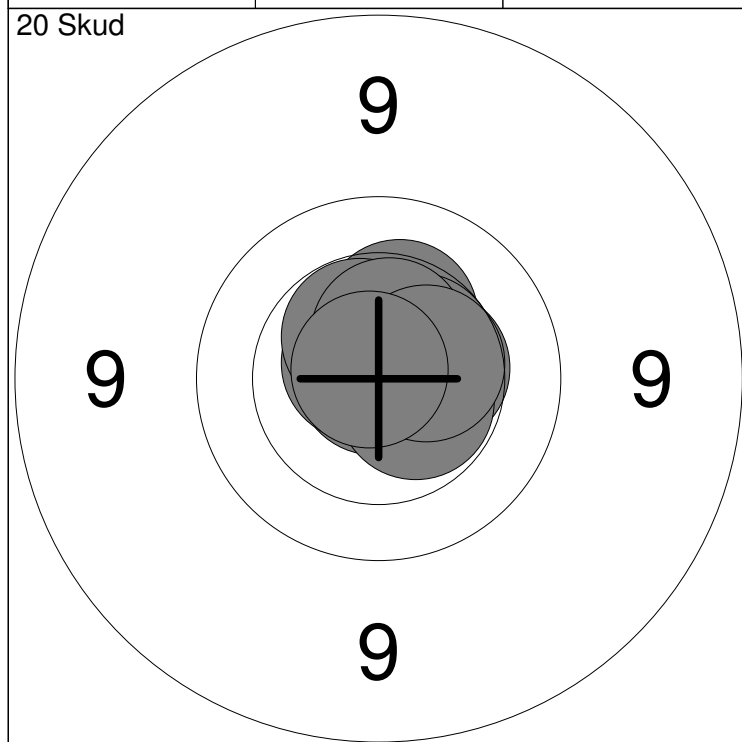

1: 10.9x ↖	6: 10.5x ↖	Serie	100
2: 10.3 ↑	7: 10.5x ↗		
3: 10.7x ↖	8: 10.5x ↑	Total	100
4: 10.4 →	9: 10.5 →		
5: 10.5x ↘	10: 10.8x ↖		

11: 10.2 →	16: 10.8x ←	Serie	100
12: 10.5x ↑	17: 10.5x ↗		
13: 10.4 ↓	18: 10.6x ↓	Total	200
14: 10.0 ↓	19: 10.1 ↓		
15: 10.4 ↖	20: 10.5 ←		

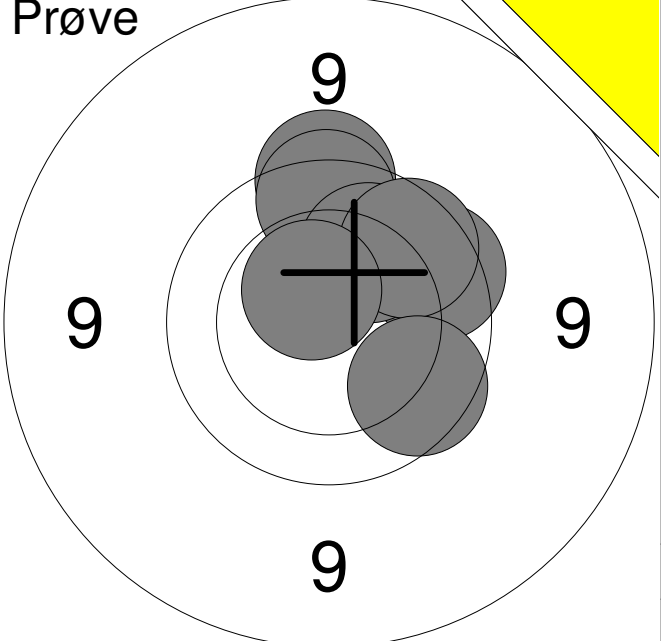
<p><b>Prøve</b></p> 	<table style="width:100%; border-collapse: collapse;"> <tr><td style="width:10%;">1:</td><td style="width:40%;">9.6</td><td style="width:50%; text-align: right;">↑</td></tr> <tr><td>2:</td><td>9.8</td><td style="text-align: right;">→</td></tr> <tr><td>3:</td><td>9.8</td><td style="text-align: right;">↑</td></tr> <tr><td>4:</td><td>10.1</td><td style="text-align: right;">↗</td></tr> <tr><td>5:</td><td>9.9</td><td style="text-align: right;">↗</td></tr> <tr><td>6:</td><td>10.6x</td><td style="text-align: right;">↖</td></tr> <tr><td>7:</td><td>9.8</td><td style="text-align: right;">↘</td></tr> </table>	1:	9.6	↑	2:	9.8	→	3:	9.8	↑	4:	10.1	↗	5:	9.9	↗	6:	10.6x	↖	7:	9.8	↘
1:	9.6	↑																				
2:	9.8	→																				
3:	9.8	↑																				
4:	10.1	↗																				
5:	9.9	↗																				
6:	10.6x	↖																				
7:	9.8	↘																				
<table style="width:100%; border-collapse: collapse;"> <tr> <td style="width:45%;"><b>Serie</b></td> <td style="width:55%; text-align: right;"><b>65.0</b></td> </tr> <tr> <td><b>Total</b></td> <td style="text-align: right;"><b>0.0</b></td> </tr> </table>		<b>Serie</b>	<b>65.0</b>	<b>Total</b>	<b>0.0</b>																	
<b>Serie</b>	<b>65.0</b>																					
<b>Total</b>	<b>0.0</b>																					

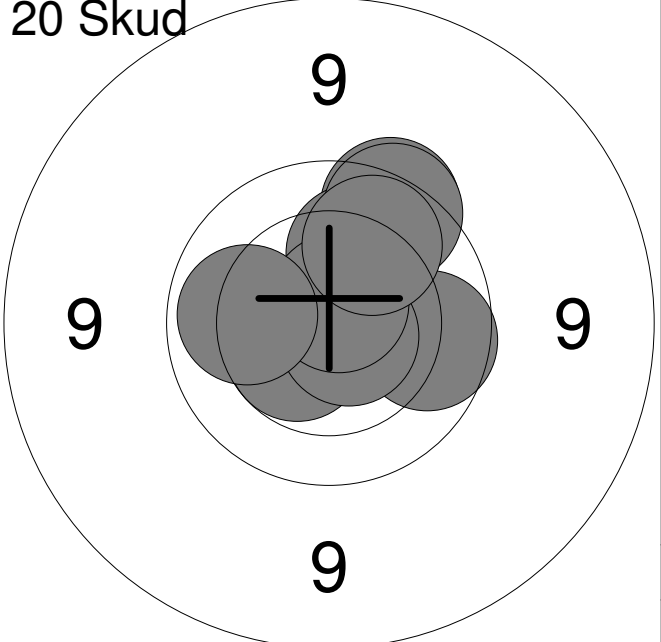
<p><b>20 Skud</b></p> 	<table style="width:100%; border-collapse: collapse;"> <tr><td style="width:10%;">1:</td><td style="width:40%;">10.7x</td><td style="width:50%; text-align: right;">↗</td></tr> <tr><td>2:</td><td>10.5x</td><td style="text-align: right;">↙</td></tr> <tr><td>3:</td><td>9.9</td><td style="text-align: right;">→</td></tr> <tr><td>4:</td><td>10.7x</td><td style="text-align: right;">↘</td></tr> <tr><td>5:</td><td>9.7</td><td style="text-align: right;">↗</td></tr> <tr><td>6:</td><td>10.1</td><td style="text-align: right;">↗</td></tr> <tr><td>7:</td><td>10.7x</td><td style="text-align: right;">↗</td></tr> <tr><td>8:</td><td>9.7</td><td style="text-align: right;">↗</td></tr> <tr><td>9:</td><td>10.1</td><td style="text-align: right;">←</td></tr> <tr><td>10:</td><td>10.0</td><td style="text-align: right;">↗</td></tr> </table>	1:	10.7x	↗	2:	10.5x	↙	3:	9.9	→	4:	10.7x	↘	5:	9.7	↗	6:	10.1	↗	7:	10.7x	↗	8:	9.7	↗	9:	10.1	←	10:	10.0	↗
1:	10.7x	↗																													
2:	10.5x	↙																													
3:	9.9	→																													
4:	10.7x	↘																													
5:	9.7	↗																													
6:	10.1	↗																													
7:	10.7x	↗																													
8:	9.7	↗																													
9:	10.1	←																													
10:	10.0	↗																													
<table style="width:100%; border-collapse: collapse;"> <tr> <td style="width:45%;"><b>Serie</b></td> <td style="width:55%; text-align: right;"><b>97.0</b></td> </tr> <tr> <td><b>Total</b></td> <td style="text-align: right;"><b>97.0</b></td> </tr> </table>		<b>Serie</b>	<b>97.0</b>	<b>Total</b>	<b>97.0</b>																										
<b>Serie</b>	<b>97.0</b>																														
<b>Total</b>	<b>97.0</b>																														

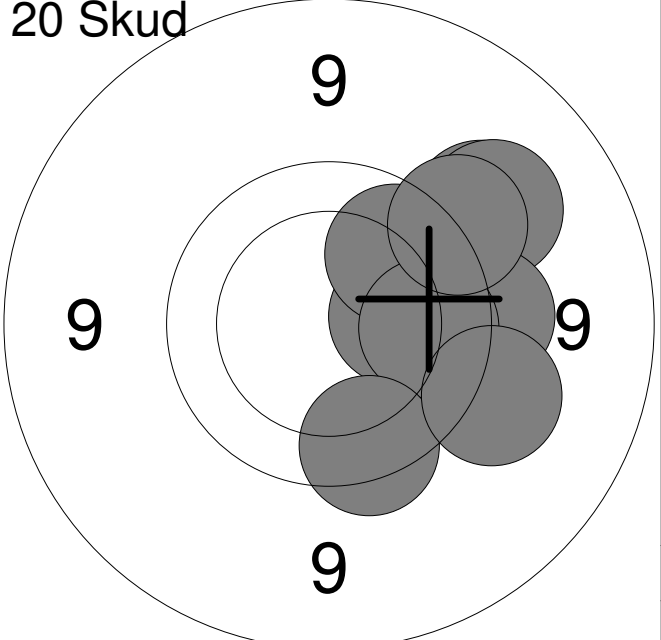
<p><b>20 Skud</b></p> 	<table style="width:100%; border-collapse: collapse;"> <tr><td style="width:10%;">11:</td><td style="width:40%;">9.4</td><td style="width:50%; text-align: right;">↗</td></tr> <tr><td>12:</td><td>9.5</td><td style="text-align: right;">↗</td></tr> <tr><td>13:</td><td>10.2</td><td style="text-align: right;">→</td></tr> <tr><td>14:</td><td>9.3</td><td style="text-align: right;">↗</td></tr> <tr><td>15:</td><td>9.9</td><td style="text-align: right;">↗</td></tr> <tr><td>16:</td><td>9.6</td><td style="text-align: right;">→</td></tr> <tr><td>17:</td><td>9.9</td><td style="text-align: right;">→</td></tr> <tr><td>18:</td><td>9.7</td><td style="text-align: right;">↓</td></tr> <tr><td>19:</td><td>9.5</td><td style="text-align: right;">↗</td></tr> <tr><td>20:</td><td>9.4</td><td style="text-align: right;">↘</td></tr> </table>	11:	9.4	↗	12:	9.5	↗	13:	10.2	→	14:	9.3	↗	15:	9.9	↗	16:	9.6	→	17:	9.9	→	18:	9.7	↓	19:	9.5	↗	20:	9.4	↘
11:	9.4	↗																													
12:	9.5	↗																													
13:	10.2	→																													
14:	9.3	↗																													
15:	9.9	↗																													
16:	9.6	→																													
17:	9.9	→																													
18:	9.7	↓																													
19:	9.5	↗																													
20:	9.4	↘																													
<table style="width:100%; border-collapse: collapse;"> <tr> <td style="width:45%;"><b>Serie</b></td> <td style="width:55%; text-align: right;"><b>91.0</b></td> </tr> <tr> <td><b>Total</b></td> <td style="text-align: right;"><b>188.0</b></td> </tr> </table>		<b>Serie</b>	<b>91.0</b>	<b>Total</b>	<b>188.0</b>																										
<b>Serie</b>	<b>91.0</b>																														
<b>Total</b>	<b>188.0</b>																														



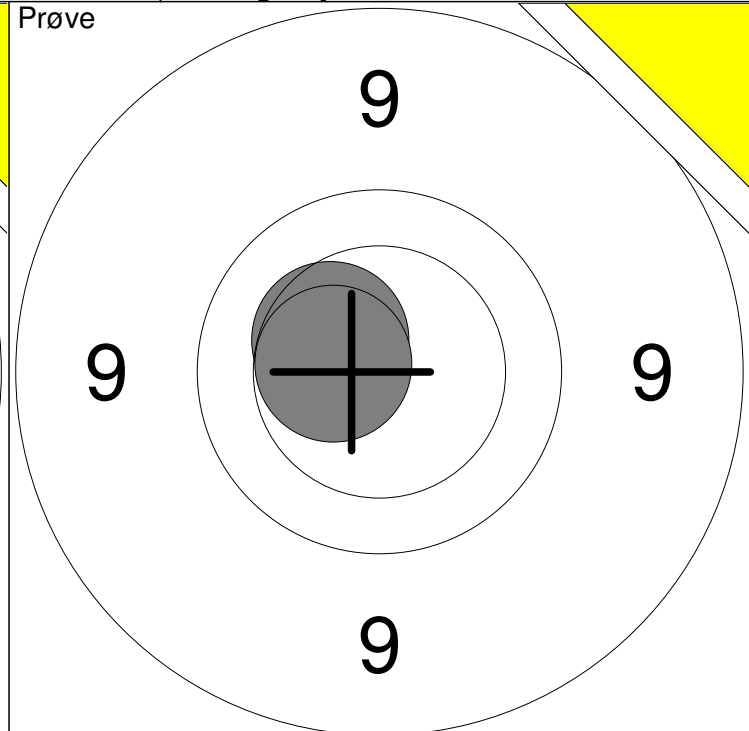
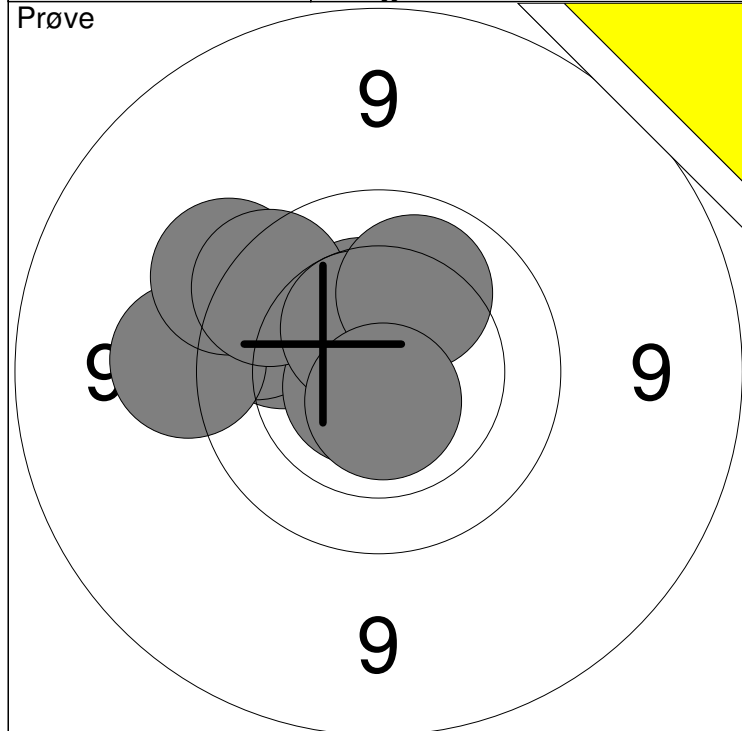

1: 10.4 ↗	6: 10.7x ↘	Serie	95
2: 9.9 ↖	7: 9.8 ↗		
3: 9.8 ↖	8: 10.5x ↗	Total	0
4: 9.5 ←	9: 10.1 ↗		
5: 9.5 ↖	10: 10.7x ↓		

11: 10.4 ↗	Serie	20
12: 10.5x ↖		
Total		0

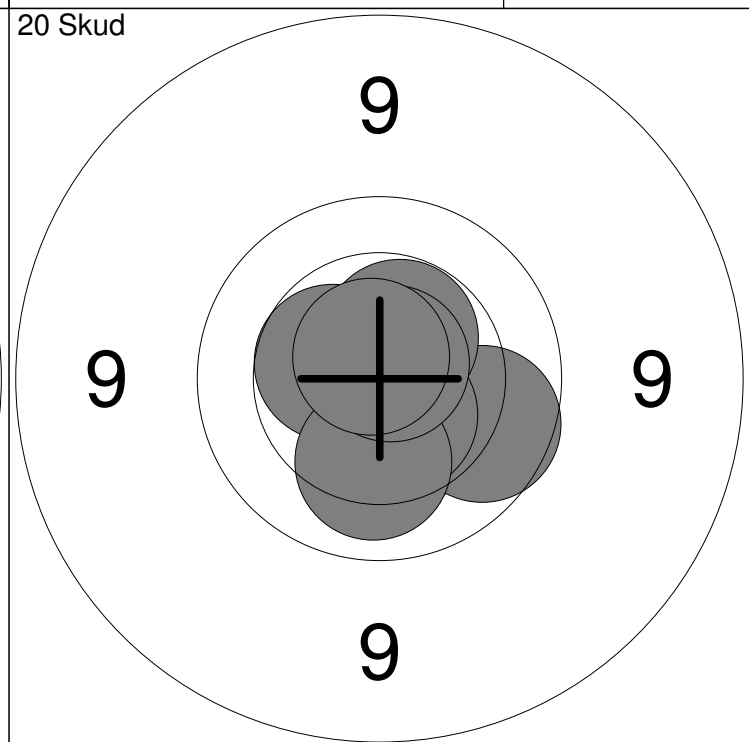
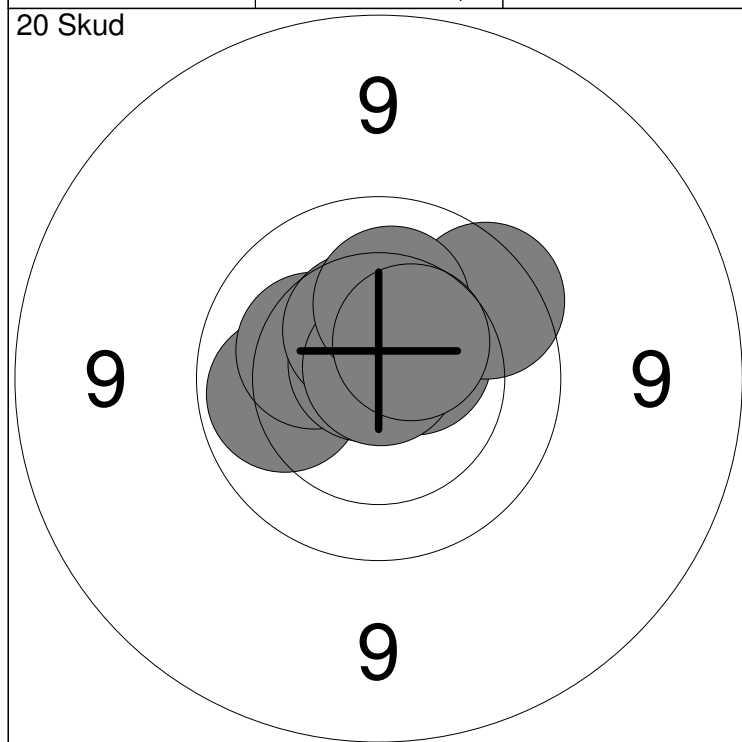

1: 10.0 ←	6: 10.8x ↗	Serie	99
2: 10.3 ↖	7: 10.5 ↗		
3: 10.3 ↗	8: 10.8x ↗	Total	99
4: 10.6x ↗	9: 10.2 ↗		
5: 9.8 ↗	10: 10.5 ↗		

11: 10.8x ↓	16: 10.6x ↓	Serie	99
12: 10.3 ↓	17: 10.5x ↗		
13: 10.7x →	18: 10.1 ↓	Total	198
14: 9.9 ↘	19: 10.8x ↗		
15: 10.5 ←	20: 10.7x ↗		

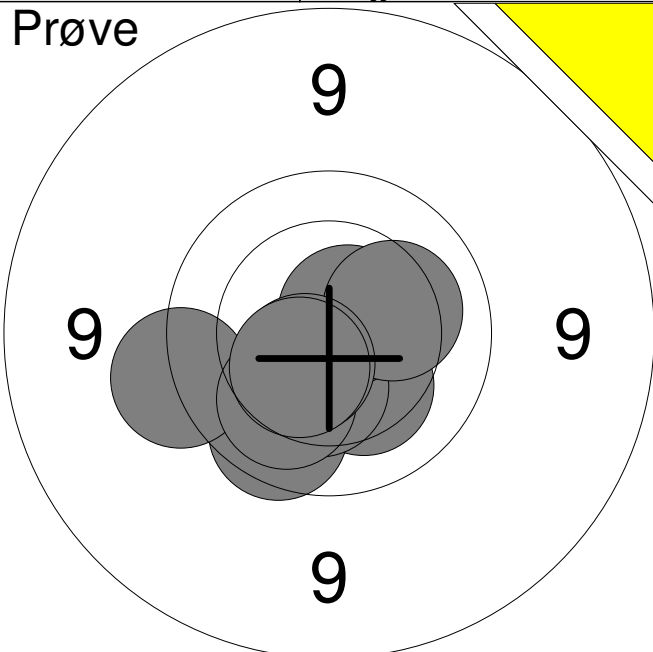
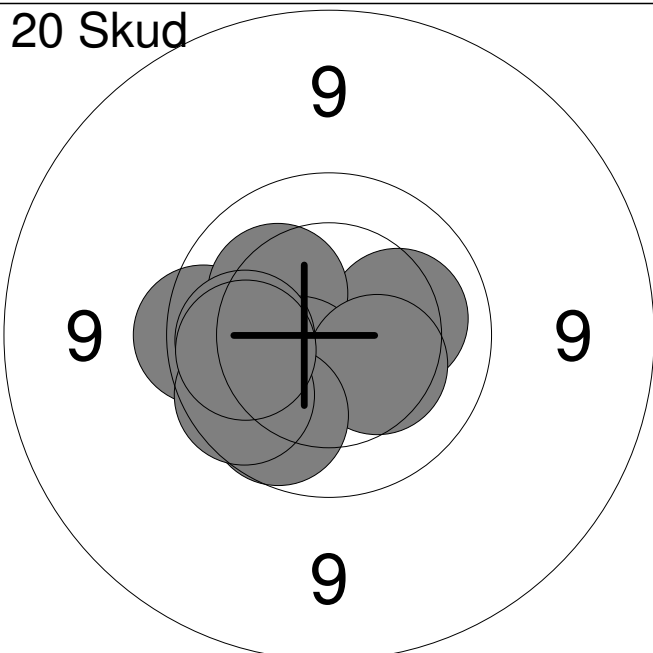
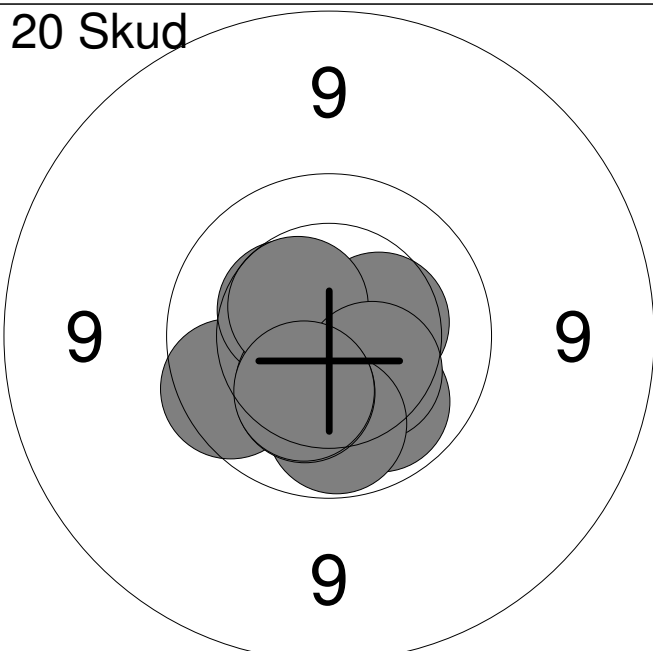
Hold	Skive	Sebastian Johansen	
17	9		
15m	Løgstør Sportsskytteklub	BK4	
30.01.2015	Nordjysk mesterskab 2015	Aalborg Skyttekreds	
Prøve		1: 10.3	↘
		2: 9.8	↘
		3: 10.4	↘
		4: 10.7x	↗
		5: 9.6	↙
		6: 10.2	→
		7: 10.1	↘
		8: 10.5x	↘
		9: 10.5	↘
		Serie	88.0
Total	0.0		
20 Skud		1: 9.7	←
		2: 10.4	↙
		3: 10.2	→
		4: 10.2	↗
		5: 10.5	↘
		6: 10.3	↘
		7: 10.0	←
		8: 9.9	↘
		9: 9.9	↙
		10: 10.0	←
Serie	97.0		
Total	97.0		
20 Skud		11: 9.8	↙
		12: 10.4	↗
		13: 10.4	→
		14: 10.4	↘
		15: 10.5x	↗
		16: 10.1	↘
		17: 10.3	↘
		18: 10.0	↘
		19: 10.3	↘
		20: 10.3	↘
Serie	99.0		
Total	196.0		

Hold <b>17</b>	Skive <b>10</b>	<b>Klara Damsgaard</b>	
-------------------	--------------------	------------------------	--

15m	Års Skf.	MJ2	
-----	----------	-----	--

30.01.2015	Nordjysk mesterskab 2015	Aalborg Skyttekreds
------------	--------------------------	---------------------

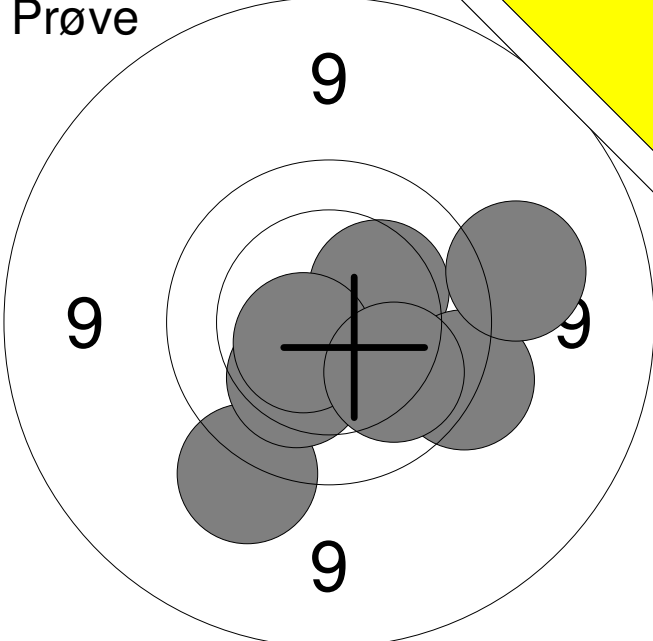
<b>Prøve</b> 	1: 10.3 →
	2: 9.6 →
	3: 9.5 ↘
	4: 10.3 ↘
	5: 9.3 →
	6: 10.6x ↙
	7: 10.1 ↘
<b>Serie</b>	<b>67.0</b>
<b>Total</b>	<b>0.0</b>

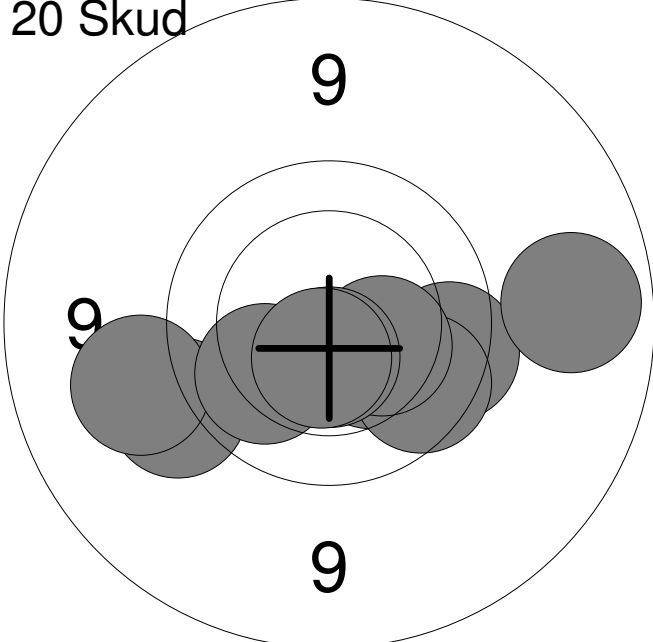
<b>20 Skud</b> 	1: 9.5 ↙
	2: 9.8 →
	3: 10.4 ↘
	4: 9.8 ↘
	5: 10.3 →
	6: 9.3 ↙
	7: 9.0 →
	8: 10.1 ↙
	9: 10.6x ↓
	10: 10.6x ↓
<b>Serie</b>	<b>95.0</b>
<b>Total</b>	<b>95.0</b>

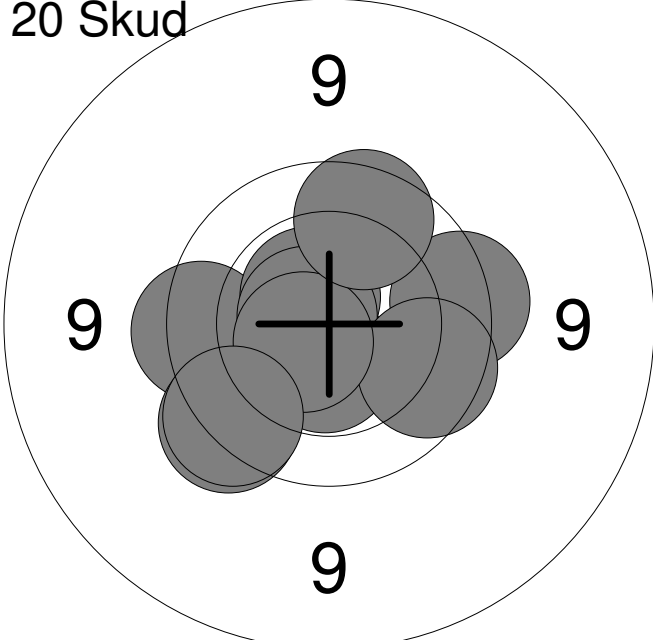
<b>20 Skud</b> 	11: 10.5x ↓
	12: 9.7 ↙
	13: 9.7 →
	14: 10.6x ↗
	15: 10.7x ↙
	16: 9.9 →
	17: 10.6x ↙
	18: 9.8 ↗
	19: 9.6 ↙
	20: 9.7 ↙
<b>Serie</b>	<b>94.0</b>
<b>Total</b>	<b>189.0</b>

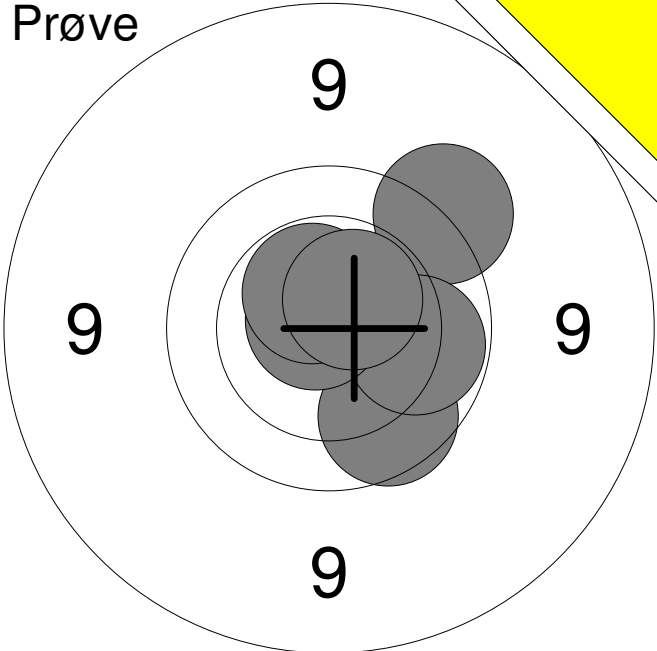
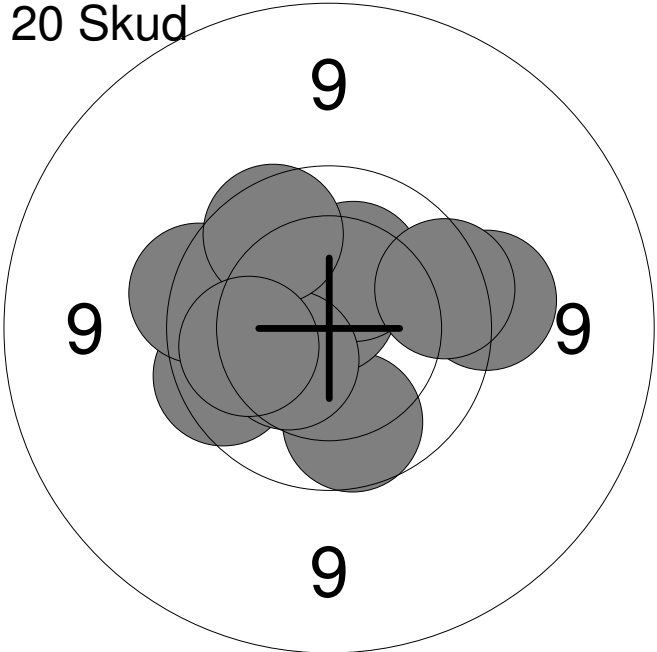
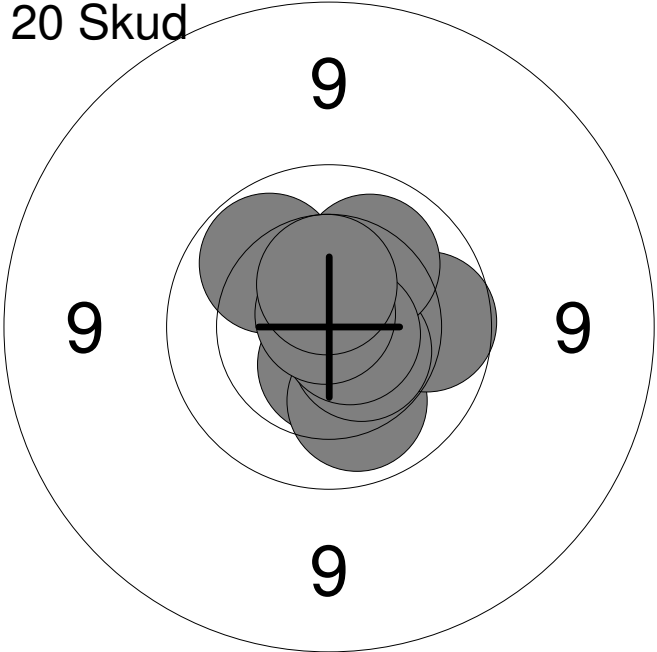
Hold	Skive	Freja Møller Pedersen	
17	11		
15m	Aalborg Skyttekreds	MJ2	
30.01.2015	Nordjysk mesterskab 2015	Aalborg Skyttekreds	
Prøve		1: 9.9	↘
		2: 9.5	↗
		3: 10.0	→
		4: 10.8x	↗
		5: 10.5x	↗
		6: 10.6x	↗
	Serie	58.0	
	Total	0.0	
20 Skud		1: 9.5	→
		2: 9.9	↘
		3: 10.7x	↑
		4: 9.8	←
		5: 10.3	↗
		6: 9.7	←
		7: 10.4	←
		8: 9.8	→
		9: 9.8	↗
		10: 10.1	←
	Serie	94.0	
	Total	94.0	
20 Skud		11: 10.5x	↓
		12: 10.1	↘
		13: 10.5	→
		14: 9.9	→
		15: 10.5x	↘
		16: 10.1	↗
		17: 10.7x	→
		18: 10.0	↗
		19: 10.8x	↗
		20: 10.5x	↑
	Serie	99.0	
	Total	193.0	

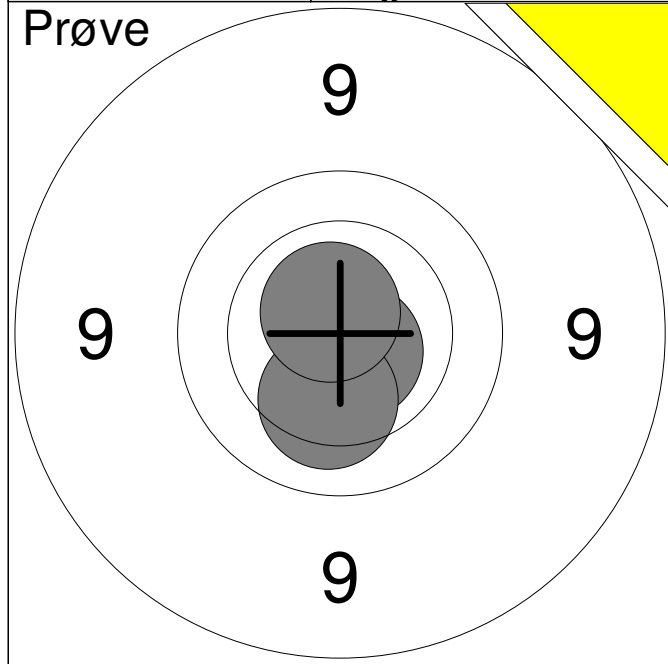

1:	10.7x	↘
2:	10.2	↘
3:	10.7x	↗
<b>Serie</b>		<b>30.0</b>
<b>Total</b>		<b>0.0</b>

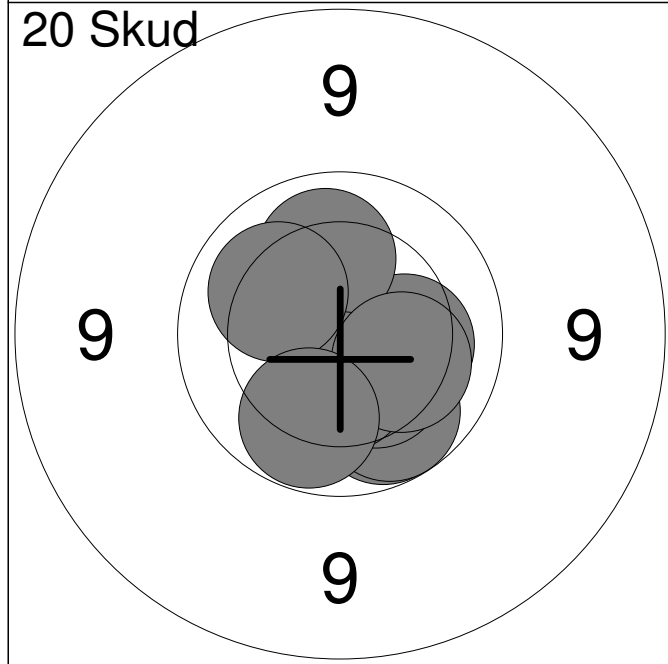

1:	10.0	↘
2:	10.2	→
3:	10.0	↘
4:	10.0	↘
5:	10.3	↘
6:	10.1	↗
7:	10.4	↘
8:	10.2	↘
9:	10.1	↗
10:	10.0	↘
<b>Serie</b>		<b>100.0</b>
<b>Total</b>		<b>100.0</b>

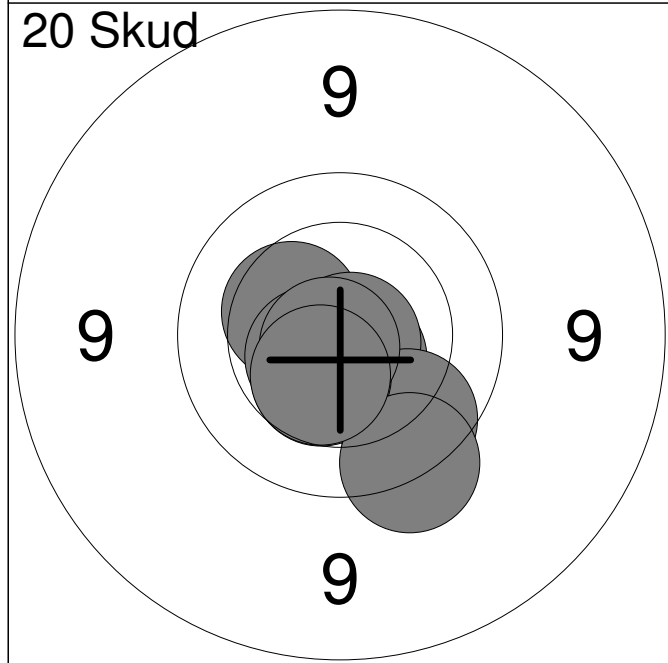

11:	10.7x	↘
12:	10.4	↗
13:	10.6x	↘
14:	10.8x	↘
15:	9.9	↘
16:	10.5	↘
17:	10.6x	↘
18:	10.8x	↘
19:	9.6	↘
20:	10.5	↘
<b>Serie</b>		<b>98.0</b>
<b>Total</b>		<b>198.0</b>

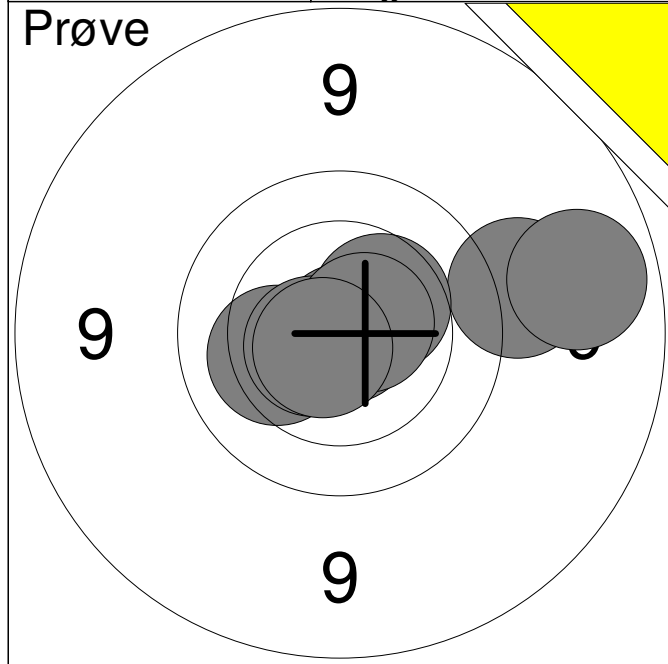

1:	10.2	←
2:	9.4	→
3:	9.0	→
4:	10.4	↗
5:	10.9x	→
6:	10.6x	←
7:	10.7x	↗
8:	10.7x	↙
<b>Serie</b>		<b>78.0</b>
<b>Total</b>		<b>0.0</b>

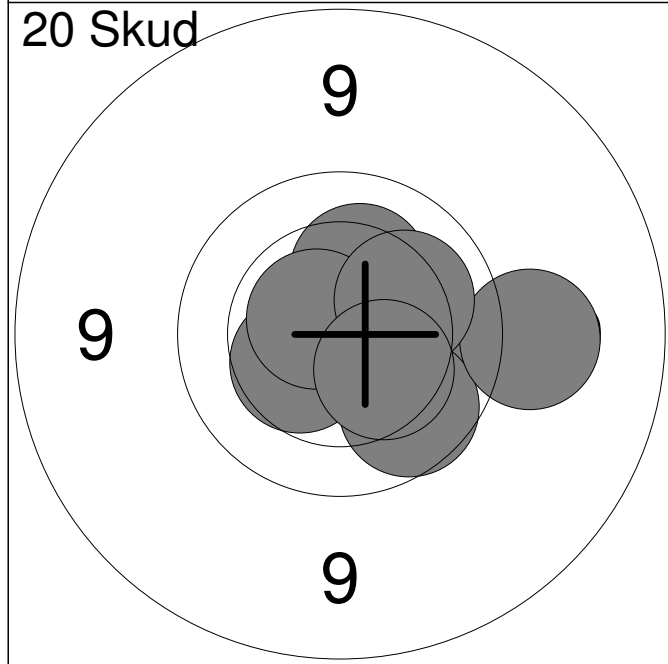

1:	10.1	→
2:	10.8x	←
3:	9.9	↘
4:	9.3	→
5:	10.9x	↙
6:	10.4	←
7:	10.3	↑
8:	10.6x	↗
9:	10.2	→
10:	10.3	↘
<b>Serie</b>		<b>98.0</b>
<b>Total</b>		<b>98.0</b>

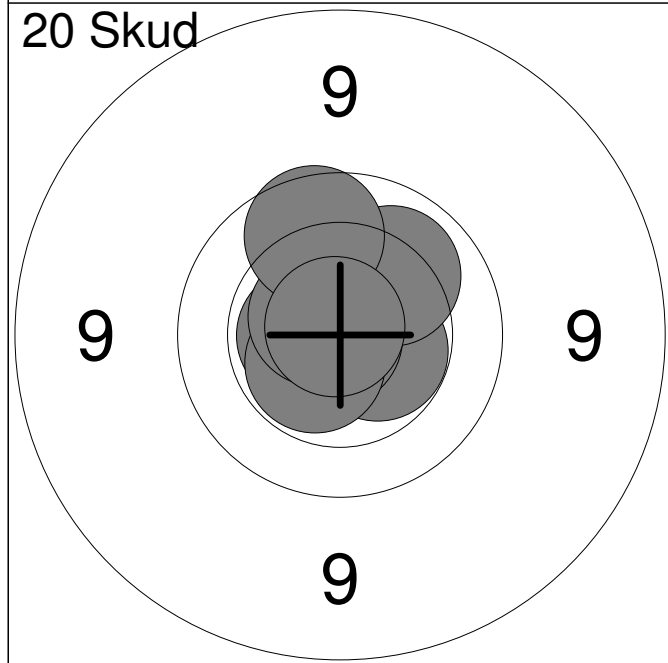

11:	10.5x	↘
12:	10.5x	↑
13:	10.9x	←
14:	10.6x	←
15:	10.5x	↙
16:	10.6x	↑
17:	10.6x	↗
18:	10.1	↗
19:	9.9	↑
20:	10.8x	↗
<b>Serie</b>		<b>99.0</b>
<b>Total</b>		<b>197.0</b>

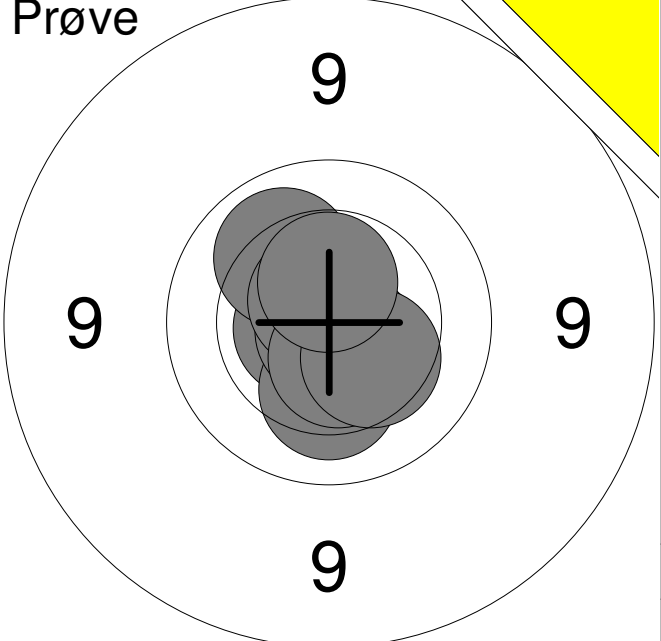
<p><b>Prøve</b></p> 	<table style="width:100%; border-collapse: collapse;"> <tr><td style="width:5%;">1:</td><td style="width:85%;">10.7x</td><td style="width:10%; text-align: right;">←</td></tr> <tr><td>2:</td><td>10.2</td><td style="text-align: right;">↓</td></tr> <tr><td>3:</td><td>10.8x</td><td style="text-align: right;">↙</td></tr> <tr><td>4:</td><td>10.7x</td><td style="text-align: right;">↘</td></tr> <tr><td>5:</td><td>10.1</td><td style="text-align: right;">↗</td></tr> <tr><td>6:</td><td>10.7x</td><td style="text-align: right;">↗</td></tr> <tr><td>7:</td><td>10.6x</td><td style="text-align: right;">↓</td></tr> <tr><td>8:</td><td>10.4</td><td style="text-align: right;">↘</td></tr> <tr><td>9:</td><td>10.5x</td><td style="text-align: right;">↑</td></tr> </table>	1:	10.7x	←	2:	10.2	↓	3:	10.8x	↙	4:	10.7x	↘	5:	10.1	↗	6:	10.7x	↗	7:	10.6x	↓	8:	10.4	↘	9:	10.5x	↑
1:	10.7x	←																										
2:	10.2	↓																										
3:	10.8x	↙																										
4:	10.7x	↘																										
5:	10.1	↗																										
6:	10.7x	↗																										
7:	10.6x	↓																										
8:	10.4	↘																										
9:	10.5x	↑																										
		<table style="width:100%; border-collapse: collapse;"> <tr> <td style="width:5%;"><b>Serie</b></td> <td style="width:85%;"></td> <td style="width:10%; text-align: right;"><b>90.0</b></td> </tr> <tr> <td><b>Total</b></td> <td></td> <td style="text-align: right;"><b>0.0</b></td> </tr> </table>	<b>Serie</b>		<b>90.0</b>	<b>Total</b>		<b>0.0</b>																				
<b>Serie</b>		<b>90.0</b>																										
<b>Total</b>		<b>0.0</b>																										

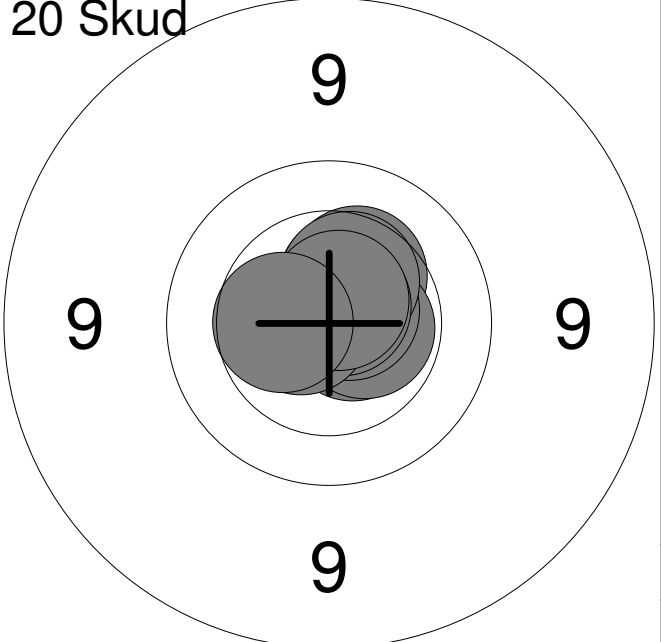
<p><b>20 Skud</b></p> 	<table style="width:100%; border-collapse: collapse;"> <tr><td style="width:5%;">1:</td><td style="width:85%;">10.7x</td><td style="width:10%; text-align: right;">→</td></tr> <tr><td>2:</td><td>10.4</td><td style="text-align: right;">↗</td></tr> <tr><td>3:</td><td>10.6x</td><td style="text-align: right;">→</td></tr> <tr><td>4:</td><td>10.5</td><td style="text-align: right;">↗</td></tr> <tr><td>5:</td><td>10.7x</td><td style="text-align: right;">↗</td></tr> <tr><td>6:</td><td>10.4</td><td style="text-align: right;">↗</td></tr> <tr><td>7:</td><td>10.7x</td><td style="text-align: right;">↗</td></tr> <tr><td>8:</td><td>10.6x</td><td style="text-align: right;">←</td></tr> <tr><td>9:</td><td>10.7x</td><td style="text-align: right;">↗</td></tr> <tr><td>10:</td><td>10.5</td><td style="text-align: right;">←</td></tr> </table>	1:	10.7x	→	2:	10.4	↗	3:	10.6x	→	4:	10.5	↗	5:	10.7x	↗	6:	10.4	↗	7:	10.7x	↗	8:	10.6x	←	9:	10.7x	↗	10:	10.5	←
1:	10.7x	→																													
2:	10.4	↗																													
3:	10.6x	→																													
4:	10.5	↗																													
5:	10.7x	↗																													
6:	10.4	↗																													
7:	10.7x	↗																													
8:	10.6x	←																													
9:	10.7x	↗																													
10:	10.5	←																													
		<table style="width:100%; border-collapse: collapse;"> <tr> <td style="width:5%;"><b>Serie</b></td> <td style="width:85%;"></td> <td style="width:10%; text-align: right;"><b>100.0</b></td> </tr> <tr> <td><b>Total</b></td> <td></td> <td style="text-align: right;"><b>100.0</b></td> </tr> </table>	<b>Serie</b>		<b>100.0</b>	<b>Total</b>		<b>100.0</b>																							
<b>Serie</b>		<b>100.0</b>																													
<b>Total</b>		<b>100.0</b>																													

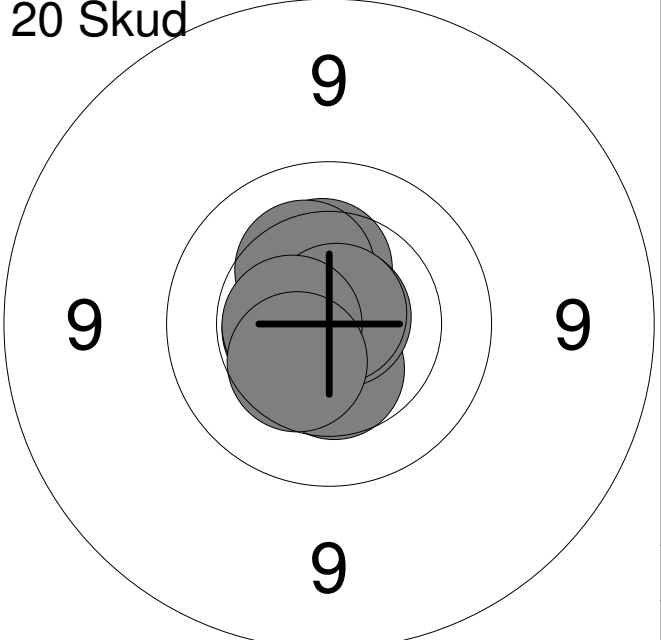
<p><b>20 Skud</b></p> 	<table style="width:100%; border-collapse: collapse;"> <tr><td style="width:5%;">11:</td><td style="width:85%;">10.5x</td><td style="width:10%; text-align: right;">↙</td></tr> <tr><td>12:</td><td>10.5x</td><td style="text-align: right;">←</td></tr> <tr><td>13:</td><td>10.3</td><td style="text-align: right;">↑</td></tr> <tr><td>14:</td><td>10.9x</td><td style="text-align: right;">→</td></tr> <tr><td>15:</td><td>10.5</td><td style="text-align: right;">↓</td></tr> <tr><td>16:</td><td>10.8x</td><td style="text-align: right;">↗</td></tr> <tr><td>17:</td><td>10.3</td><td style="text-align: right;">↗</td></tr> <tr><td>18:</td><td>10.8x</td><td style="text-align: right;">↗</td></tr> <tr><td>19:</td><td>10.5x</td><td style="text-align: right;">←</td></tr> <tr><td>20:</td><td>10.4</td><td style="text-align: right;">↙</td></tr> </table>	11:	10.5x	↙	12:	10.5x	←	13:	10.3	↑	14:	10.9x	→	15:	10.5	↓	16:	10.8x	↗	17:	10.3	↗	18:	10.8x	↗	19:	10.5x	←	20:	10.4	↙
11:	10.5x	↙																													
12:	10.5x	←																													
13:	10.3	↑																													
14:	10.9x	→																													
15:	10.5	↓																													
16:	10.8x	↗																													
17:	10.3	↗																													
18:	10.8x	↗																													
19:	10.5x	←																													
20:	10.4	↙																													
		<table style="width:100%; border-collapse: collapse;"> <tr> <td style="width:5%;"><b>Serie</b></td> <td style="width:85%;"></td> <td style="width:10%; text-align: right;"><b>100.0</b></td> </tr> <tr> <td><b>Total</b></td> <td></td> <td style="text-align: right;"><b>200.0</b></td> </tr> </table>	<b>Serie</b>		<b>100.0</b>	<b>Total</b>		<b>200.0</b>																							
<b>Serie</b>		<b>100.0</b>																													
<b>Total</b>		<b>200.0</b>																													

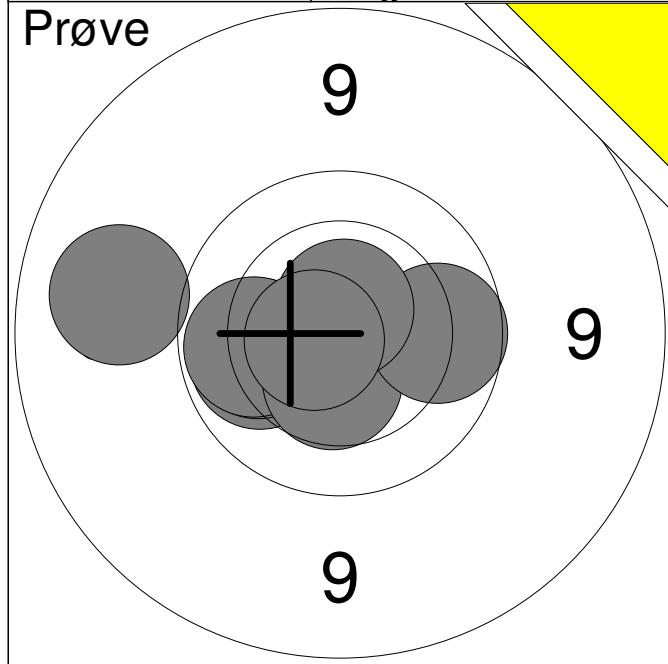

1:	9.1	←
2:	10.0	←
3:	10.1	←
4:	10.0	←
5:	10.4	↓
6:	9.9	→
7:	10.7x	↑
8:	10.7x	←
<b>Serie</b>		<b>78.0</b>
<b>Total</b>		<b>0.0</b>

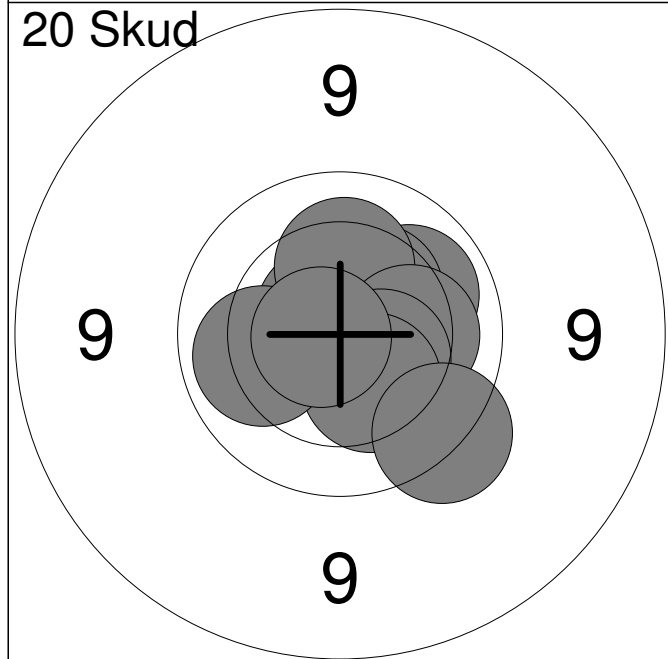

1:	10.7x	↖
2:	10.1	↗
3:	10.4	↗
4:	10.2	↑
5:	10.2	→
6:	10.4	↘
7:	10.3	↘
8:	10.1	←
9:	10.7x	←
10:	9.6	↘
<b>Serie</b>		<b>99.0</b>
<b>Total</b>		<b>99.0</b>

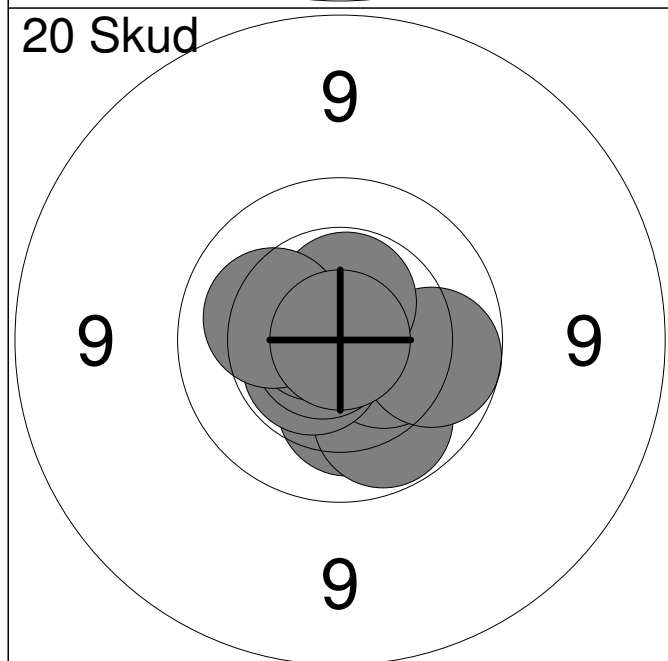

11:	10.2	↓
12:	10.0	↓
13:	10.4	↘
14:	10.6x	↘
15:	10.7x	←
16:	9.9	→
17:	10.7x	↖
18:	10.5x	↑
19:	10.2	←
20:	10.9x	↘
<b>Serie</b>		<b>99.0</b>
<b>Total</b>		<b>198.0</b>



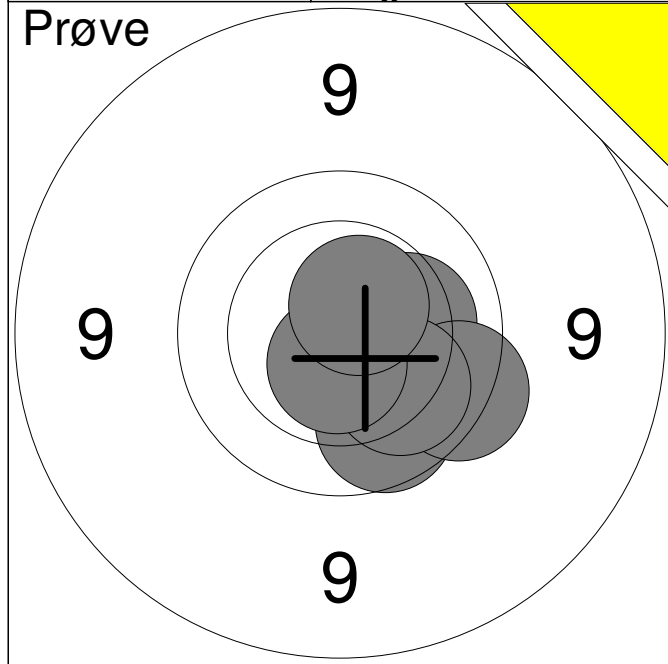

1:	10.3	↘
2:	10.7x	↘
3:	9.9	↘
4:	10.2	→
5:	9.7	↘
6:	10.1	↘
7:	10.6x	↘
8:	10.6x	↗

<b>Serie</b>	<b>78.0</b>
<b>Total</b>	<b>0.0</b>

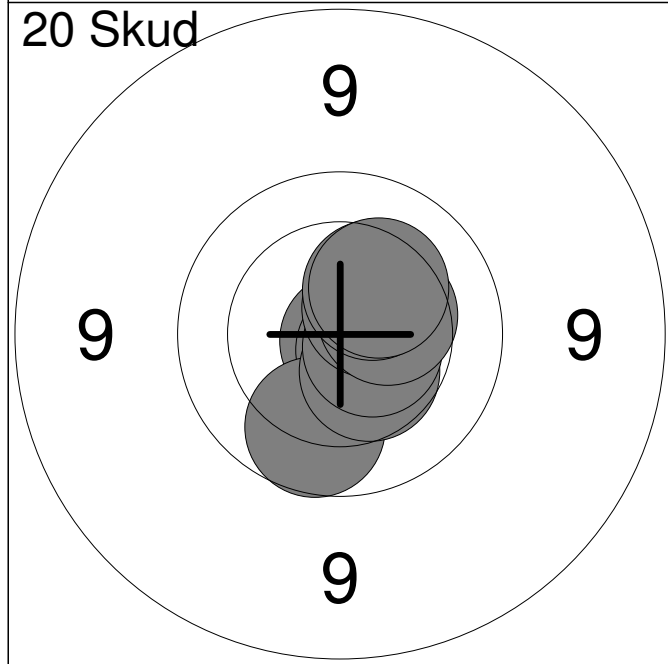

1:	10.7x	↘
2:	10.8x	↘
3:	10.6x	↘
4:	9.9	↘
5:	10.4	↘
6:	10.6x	↘
7:	10.5x	↗
8:	10.4	→
9:	10.4	↗
10:	10.3	↗

<b>Serie</b>	<b>99.0</b>
<b>Total</b>	<b>99.0</b>

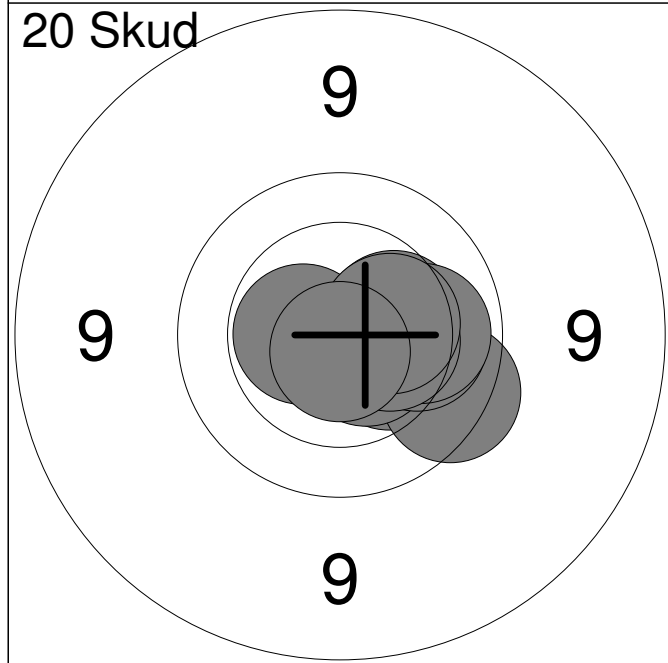

11:	10.4	↘
12:	9.8	↘
13:	10.4	→
14:	10.6x	↘
15:	10.6x	←
16:	10.1	→
17:	10.1	→
18:	10.4	→
19:	10.4	→
20:	10.8x	↓

<b>Serie</b>	<b>99.0</b>
<b>Total</b>	<b>198.0</b>

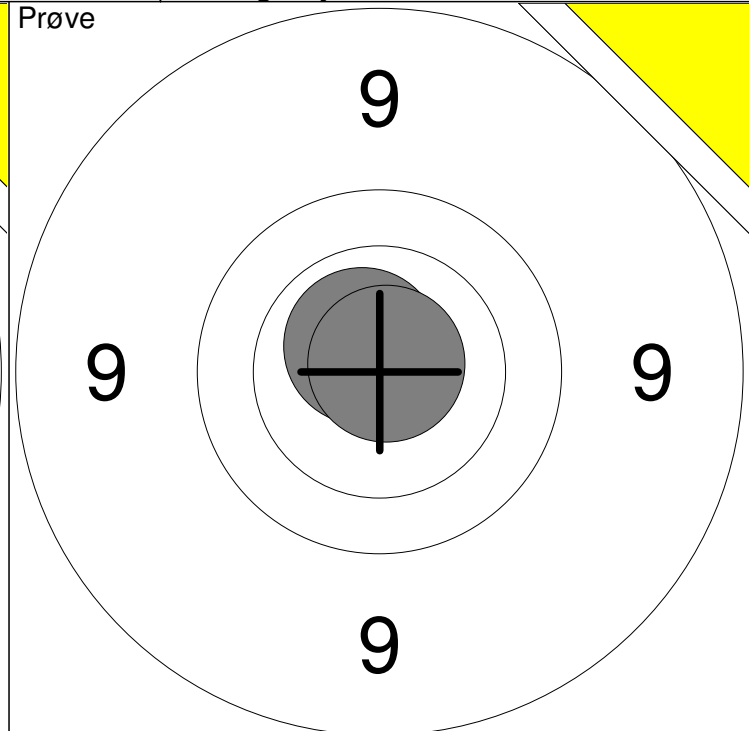
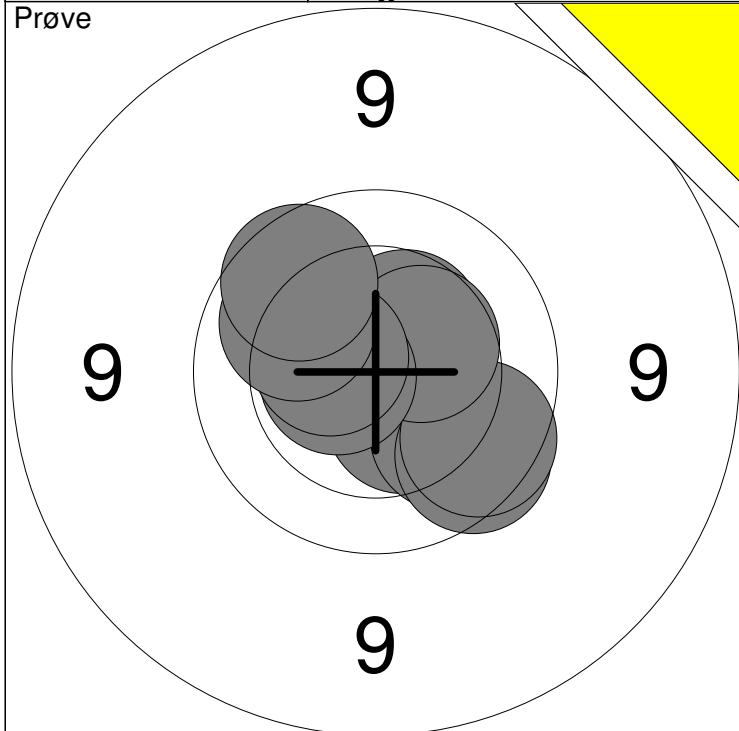

1: 10.5 ↘	6: 10.4 ↗	Serie	97
2: 10.0 ↘	7: 10.6x ←		
3: 9.8 ↘	8: 10.5 ←	Total	0
4: 9.8 ↘	9: 10.1 ↗		
5: 10.4 ↗	10: 9.9 ↗		

11: 10.6x ↖	Serie	20
12: 10.8x ↗		
Total		0

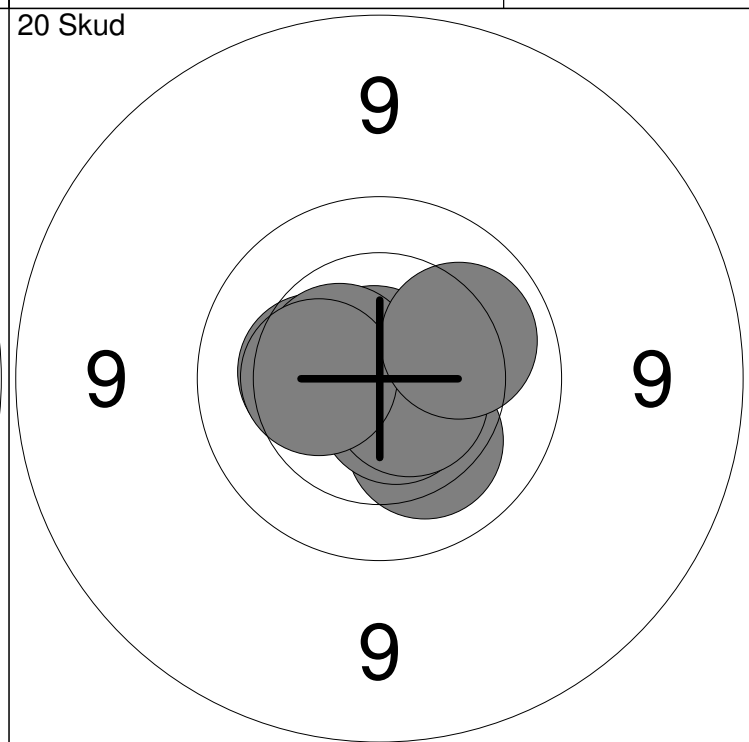
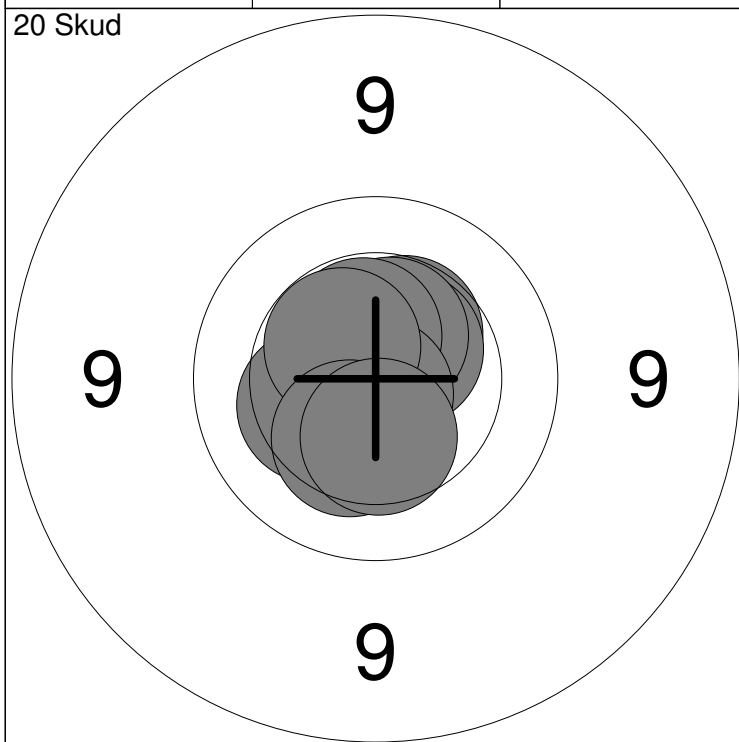

1: 10.4 ↗	6: 10.5x ↗	Serie	100
2: 10.3 ←	7: 10.8x ↓		
3: 10.5x ↗	8: 10.5x ↖	Total	100
4: 10.7x ↑	9: 10.3 ↓		
5: 10.5x ↗	10: 10.4 ↓		

11: 10.6x →	16: 10.8x ↗	Serie	100
12: 10.7x ↓	17: 10.5x ←		
13: 10.3 ←	18: 10.6x ↓	Total	200
14: 10.2 ↓	19: 10.4 ←		
15: 10.6x ↓	20: 10.1 ↗		

Hold <b>18</b>	Skive <b>6</b>	<b>Josephine M. Holm</b>	
-------------------	-------------------	--------------------------	--

15m	Skf. Kimbrene	BK2
-----	---------------	-----

30.01.2015	Nordjysk mesterskab 2015	Aalborg Skyttekreds
------------	--------------------------	---------------------

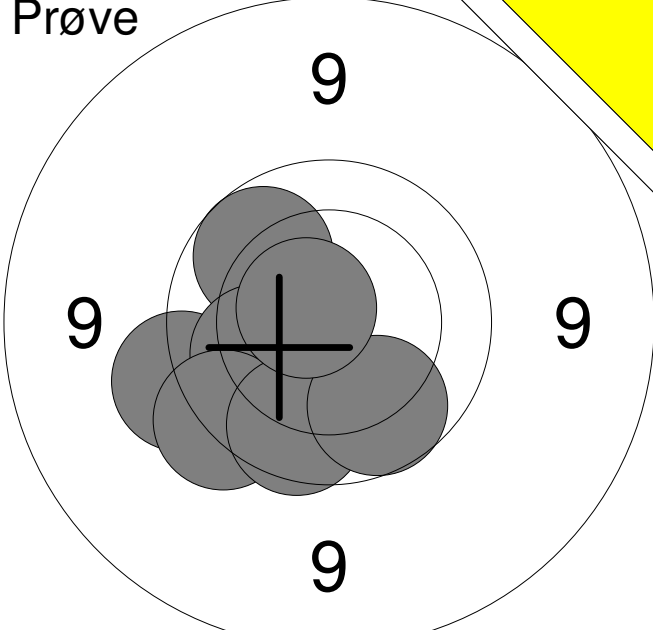
<b>Prøve</b> 	1: 9.9 ↗ 2: 9.5 ↖ 3: 10.1 ↖ 4: 9.6 ↖ 5: 9.9 ↓ 6: 9.9 ↓ 7: 10.7x ↗
	<b>Serie</b> 65.0 <b>Total</b> 0.0

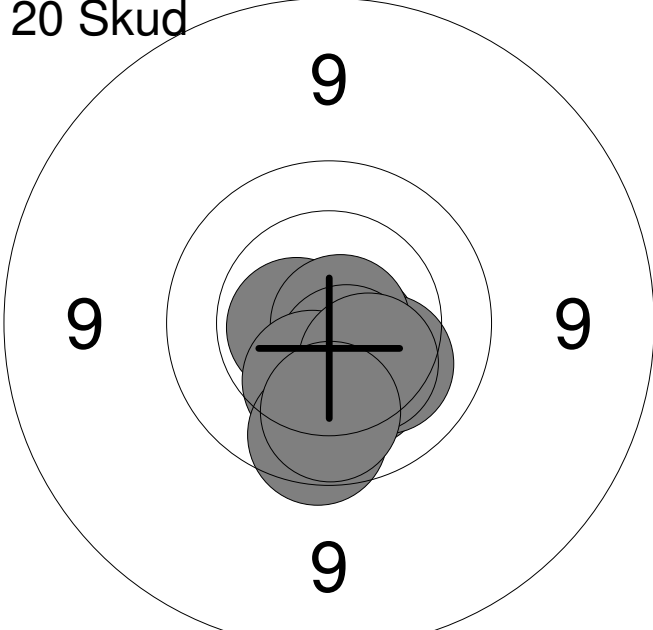
<b>20 Skud</b> 	1: 10.7x ↘ 2: 10.3 ↘ 3: 10.2 ↘ 4: 10.6x ← 5: 10.8x → 6: 10.6x ↘ 7: 10.3 ↘ 8: 9.8 ↘ 9: 10.3 ↘ 10: 10.0 ↓
	<b>Serie</b> 99.0 <b>Total</b> 99.0

<b>20 Skud</b> 	11: 10.1 ↖ 12: 10.4 ↓ 13: 10.4 ↖ 14: 9.8 ↓ 15: 10.7x ↗ 16: 10.1 ↓ 17: 10.1 ↓ 18: 10.5 ↖ 19: 10.3 ↓ 20: 10.7x ↑
	<b>Serie</b> 99.0 <b>Total</b> 198.0

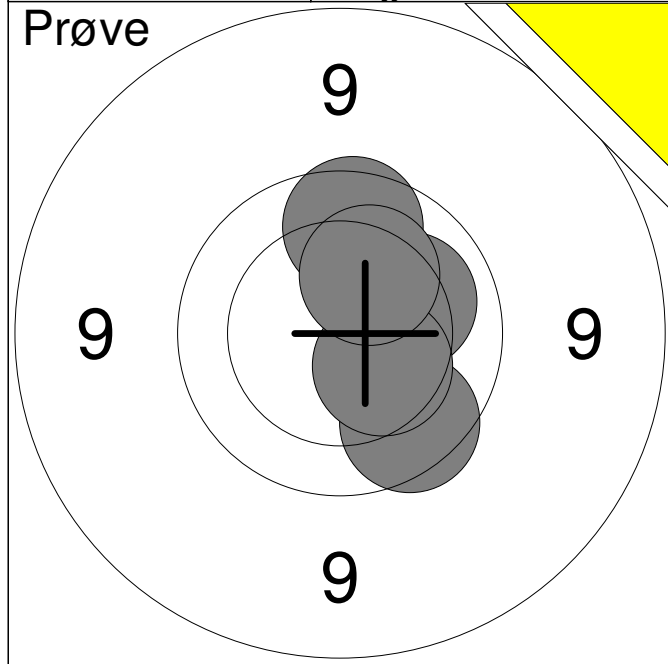

1:	9.8	↘
2:	9.9	↑
3:	10.2	→
4:	10.4	↘
5:	10.2	↑
<b>Serie</b>	<b>48.0</b>	
<b>Total</b>	<b>0.0</b>	

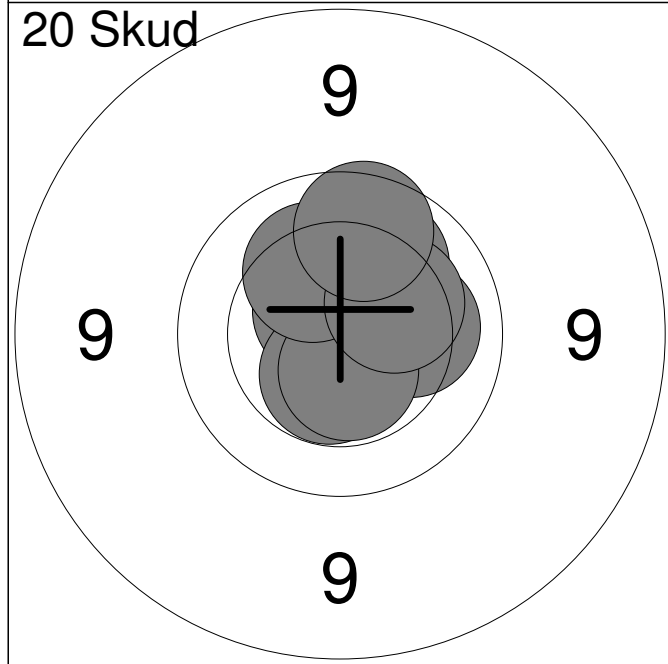

1:	10.6x	↗
2:	10.2	↗
3:	10.7x	→
4:	10.5x	↘
5:	10.2	→
6:	10.5x	↘
7:	10.1	↗
8:	10.2	↗
9:	10.3	→
10:	9.9	↑
<b>Serie</b>	<b>99.0</b>	
<b>Total</b>	<b>99.0</b>	

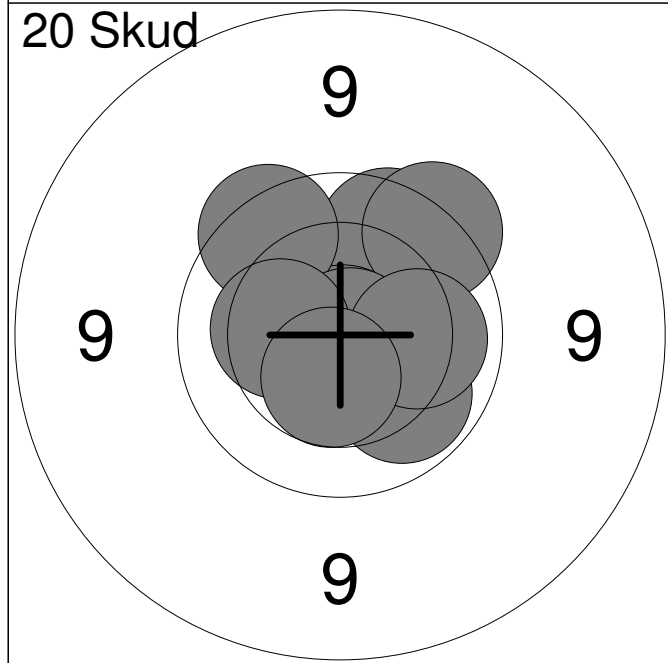

11:	10.6x	↑
12:	9.9	↑
13:	10.0	↘
14:	10.9x	→
15:	9.7	↗
16:	9.8	↗
17:	10.8x	→
18:	10.3	←
19:	10.1	→
20:	10.5	↘
<b>Serie</b>	<b>97.0</b>	
<b>Total</b>	<b>196.0</b>	

Hold <b>18</b>	Skive <b>8</b>	<b>Kasper M. Nielsen</b>	
-------------------	-------------------	--------------------------	--

15m	Vilsted Skf.	BK3
-----	--------------	-----

30.01.2015	Nordjysk mesterskab 2015	Aalborg Skyttekreds
------------	--------------------------	---------------------

<b>Prøve</b> 	1: 10.4	←
	2: 9.9	↑
	3: 8.9	↑
	4: 10.0	↑
	5: 9.3	↑
	6: 9.6	↗
	7: 10.5x	↑
	8: 10.8x	↘
	9: 10.7x	←
	<b>Serie</b>	<b>85.0</b>
<b>Total</b>	<b>0.0</b>	

<b>20 Skud</b> 	1: 10.6x	←
	2: 9.7	↗
	3: 8.0	↑
	4: 10.8x	↘
	5: 9.1	↗
	6: 10.8x	↗
	7: 10.1	→
	8: 9.2	↑
	9: 9.3	↗
	10: 10.4	→
<b>Serie</b>	<b>94.0</b>	
<b>Total</b>	<b>94.0</b>	

<b>20 Skud</b> 	11: 10.3	↘
	12: 9.9	↑
	13: 10.3	↘
	14: 10.0	→
	15: 10.7x	←
	16: 10.4	↗
	17: 9.9	↑
	18: 9.0	↗
	19: 10.5x	↗
	20: 9.0	↑
<b>Serie</b>	<b>96.0</b>	
<b>Total</b>	<b>190.0</b>	

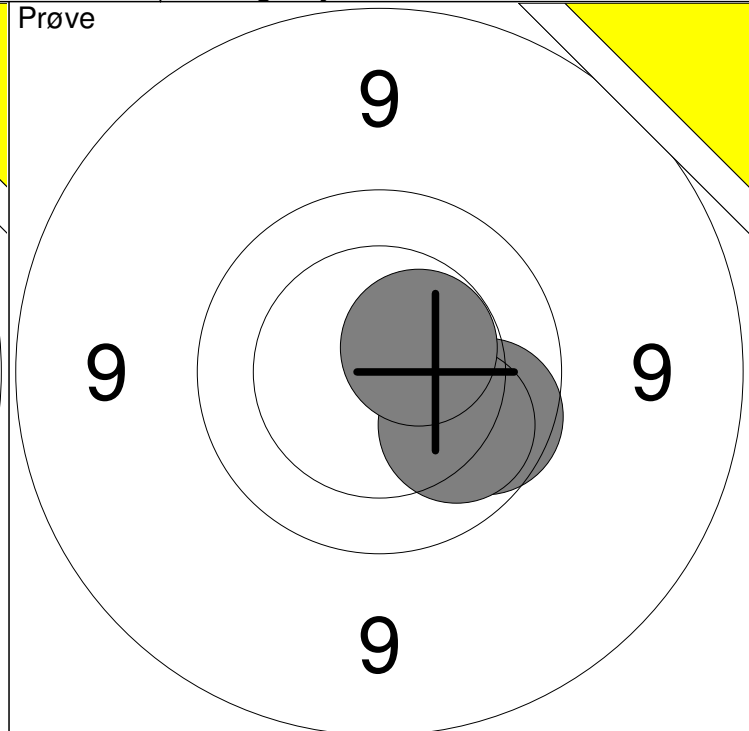
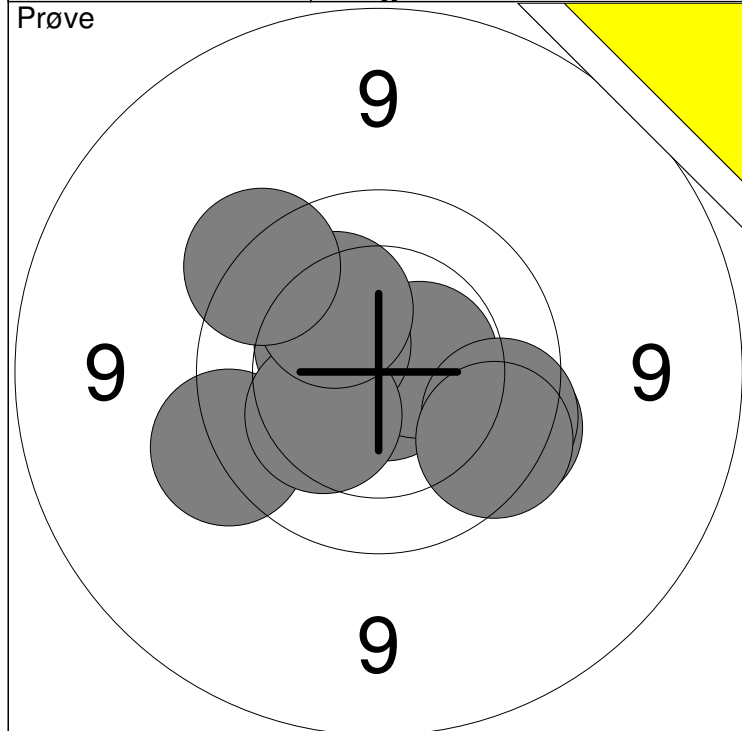

1: 10.8x ↘	6: 10.2 ↗	Serie	95
2: 10.5x →	7: 9.7 ↗		
3: 10.4 ↖	8: 9.8 ↘	Total	0
4: 9.6 ←	9: 9.8 ↘		
5: 10.3 ↙	10: 9.8 ↘		

11: 9.9 →	Serie	29
12: 10.0 ↘		
13: 10.5x ↗	Total	0

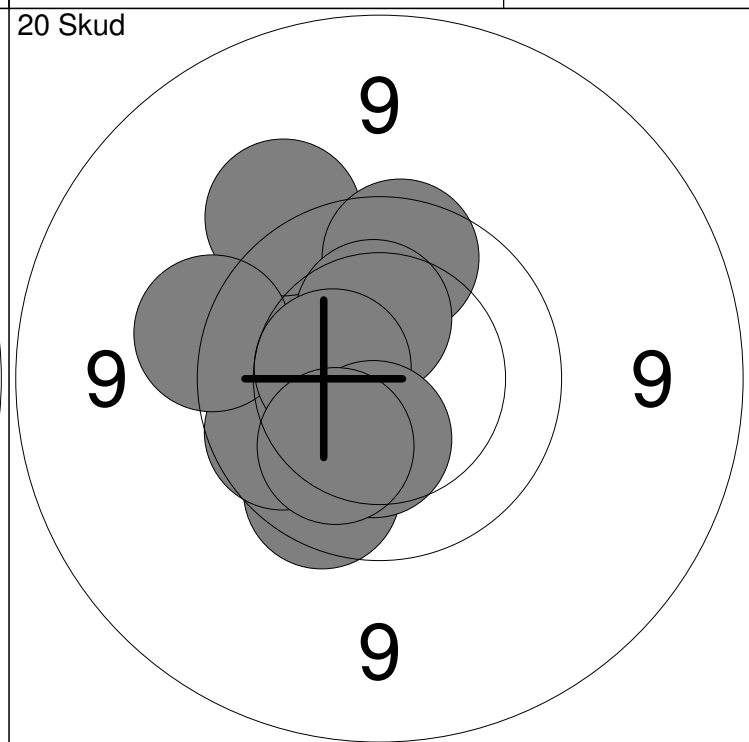
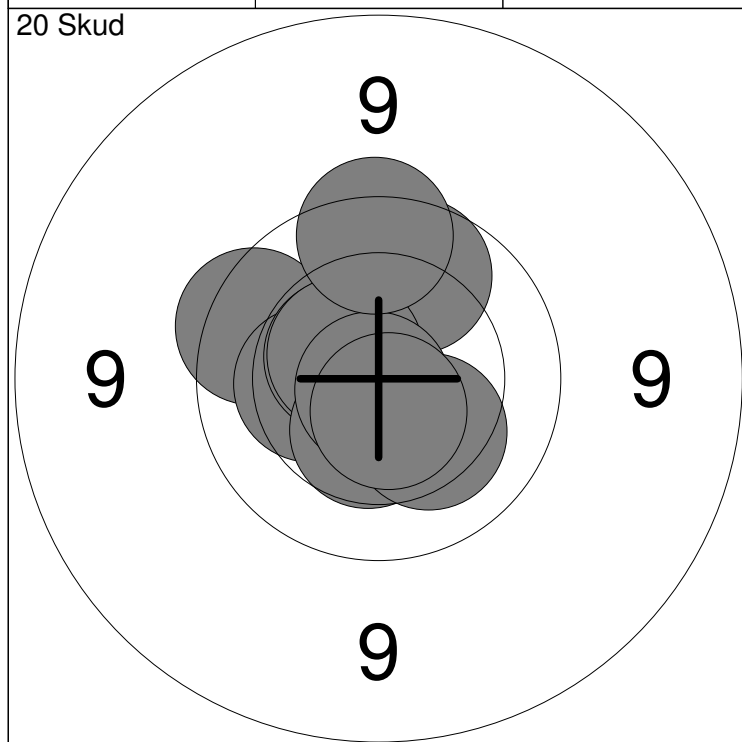

1: 9.8 ↖	6: 10.4 ↓	Serie	97
2: 9.9 ↗	7: 10.8x ↓		
3: 10.3 ←	8: 10.2 ↓	Total	97
4: 10.5x ↖	9: 10.6x ↓		
5: 10.6x ↖	10: 9.7 ↗		

11: 9.8 ↖	16: 9.9 ↖	Serie	94
12: 9.8 ↘	17: 9.6 ↖		
13: 9.5 ↗	18: 10.5 ↖	Total	191
14: 9.8 ↗	19: 10.4 ↓		
15: 10.4 ↗	20: 10.2 ↘		

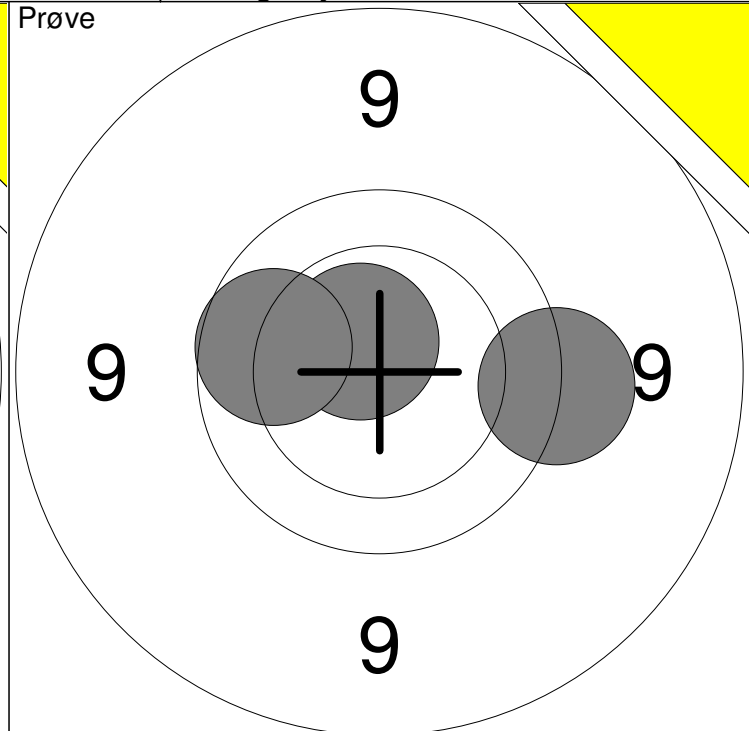
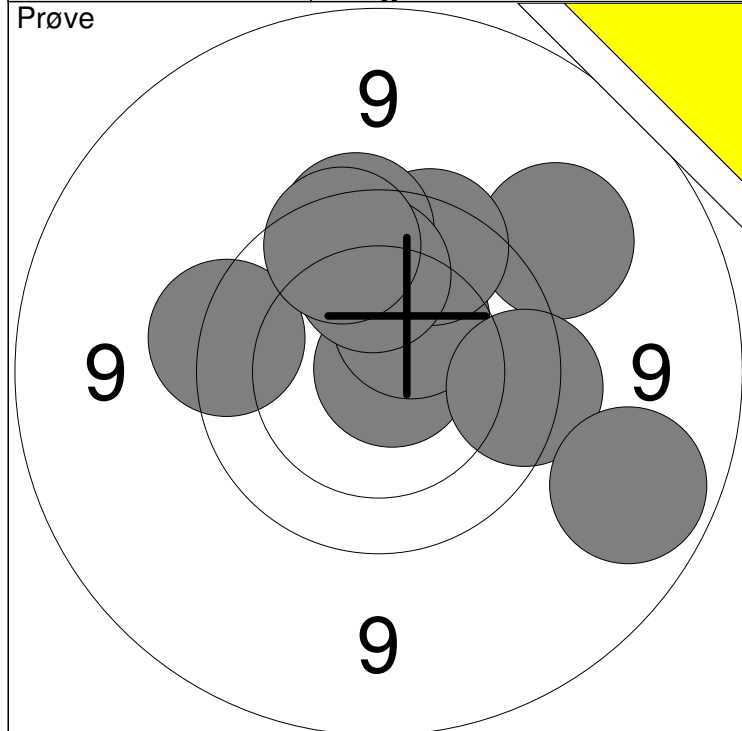

1: 10.8x →	6: 9.7 ←	<b>Serie</b> 93
2: 10.4 ↗	7: 9.7 ↑	
3: 9.3 ↗	8: 9.0 →	<b>Total</b> 0
4: 9.8 ↑	9: 10.0 ↑	
5: 9.7 →	10: 9.8 ↑	

11: 9.5 →	<b>Serie</b> 28
12: 10.6x ↗	
13: 9.9 ←	<b>Total</b> 0

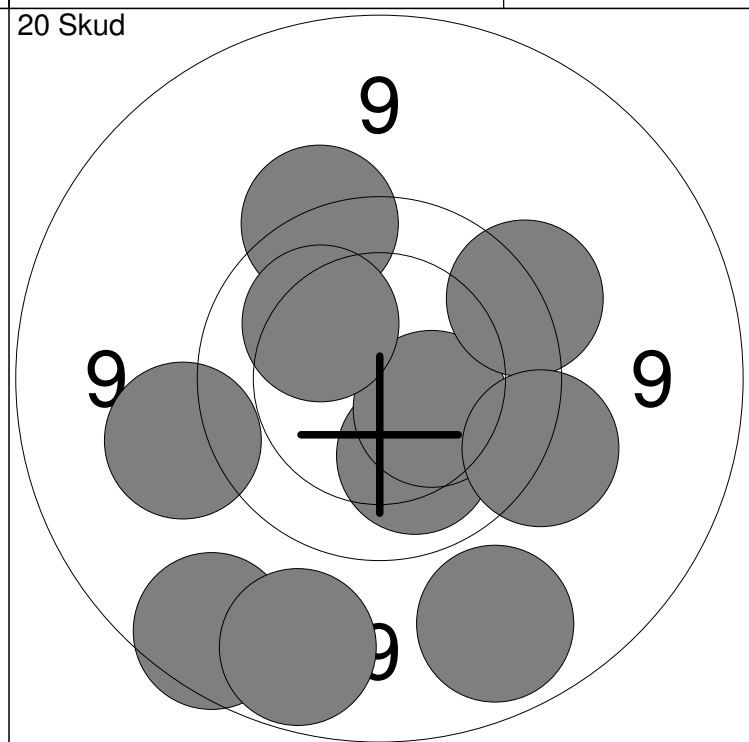
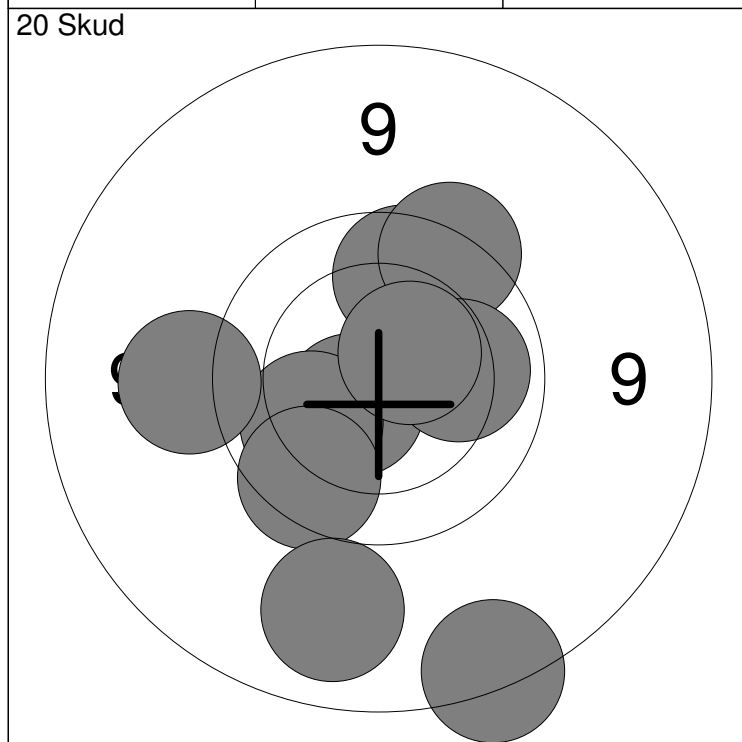

1: 9.9 ↑	6: 10.1 ←	<b>Serie</b> 93
2: 10.6x ↙	7: 9.8 ↙	
3: 8.7 ↓	8: 10.5x ↗	<b>Total</b> 93
4: 9.7 ↗	9: 9.1 ↓	
5: 10.1 →	10: 9.4 ←	

11: 9.4 ←	16: 9.6 ↗	<b>Serie</b> 92
12: 9.6 ↗	17: 10.2 ↗	
13: 10.1 ↓	18: 8.9 ↓	<b>Total</b> 185
14: 9.0 ↓	19: 9.0 ↓	
15: 10.4 ↘	20: 9.6 ↘	

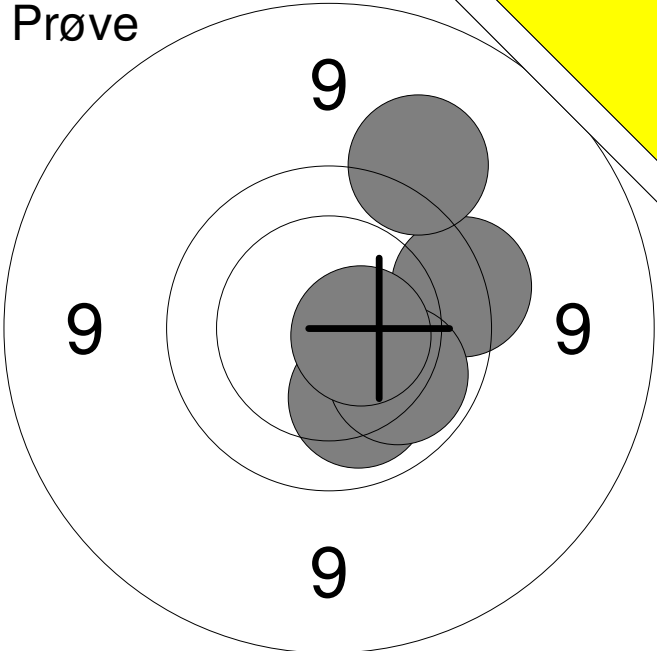
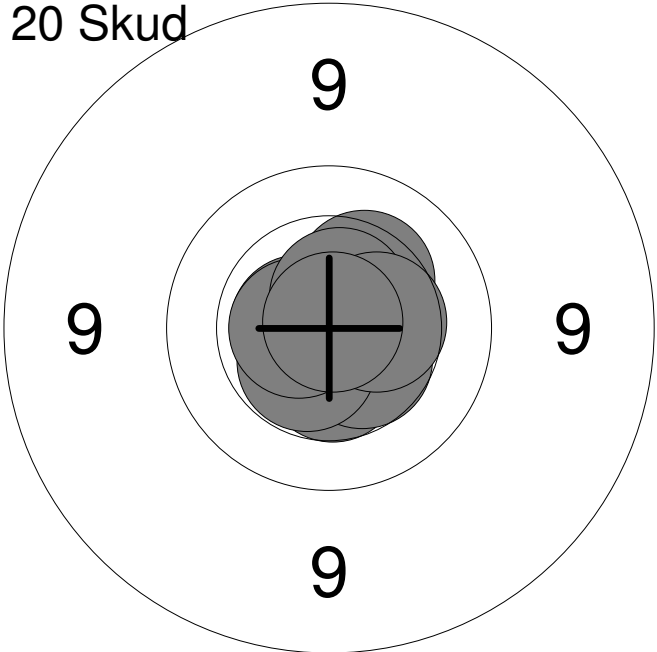
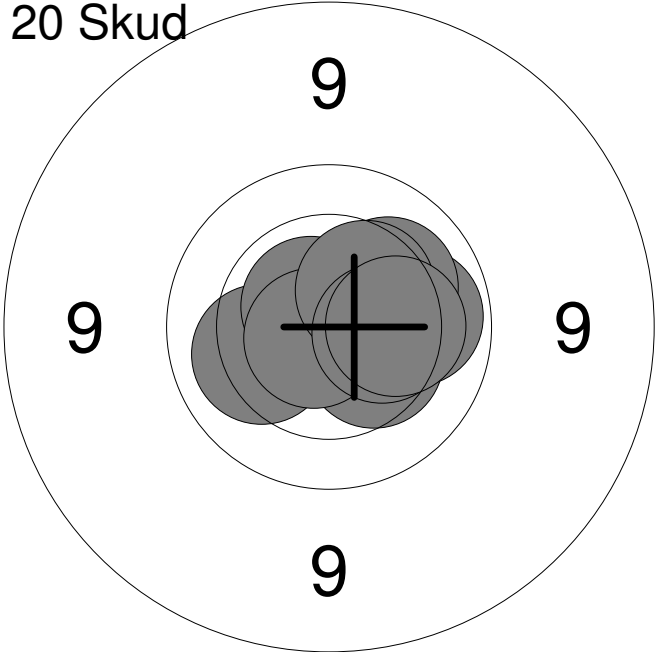
Hold	Skive	Frederik Rubæk	
19	1	Skf. Kimbrene	J2
15m			
30.01.2015	Nordjysk mesterskab 2015	Aalborg Skyttekreds	
Prøve		1: 9.7 →	
		2: 9.4 ↗	
		3: 10.1 ↘	
		4: 10.1 ↘	
		5: 10.6x →	
		<b>Serie</b>	<b>48.0</b>
		<b>Total</b>	<b>0.0</b>
20 Skud		1: 10.5 ↓	
		2: 10.6x ←	
		3: 10.5 ↘	
		4: 10.5x ↘	
		5: 10.6x ←	
		6: 10.3 ↗	
		7: 10.7x ↗	
		8: 10.6x ↑	
		9: 10.4 →	
		10: 10.9x ↗	
		<b>Serie</b>	<b>100.0</b>
		<b>Total</b>	<b>100.0</b>
20 Skud		11: 10.4 ↘	
		12: 10.0 →	
		13: 10.2 ←	
		14: 10.7x →	
		15: 10.2 ↗	
		16: 10.7x ↗	
		17: 10.7x ↘	
		18: 10.4 ↗	
		19: 10.4 →	
		20: 10.2 →	
		<b>Serie</b>	<b>100.0</b>
		<b>Total</b>	<b>200.0</b>

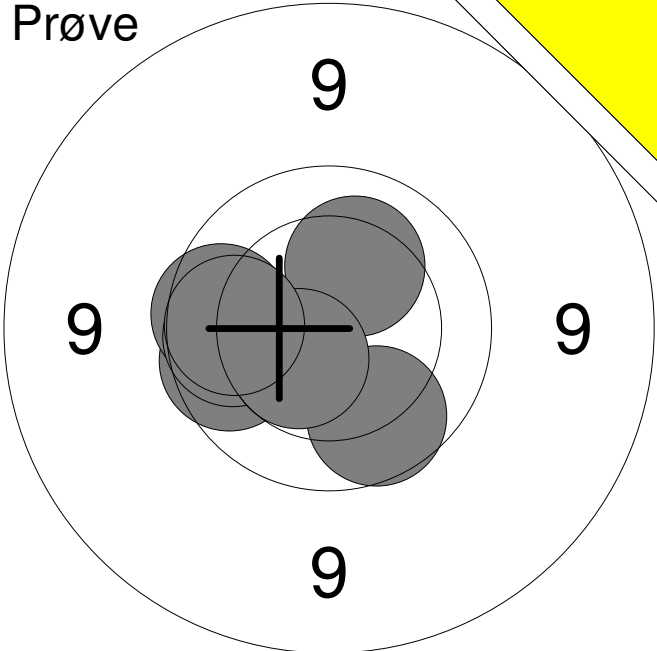
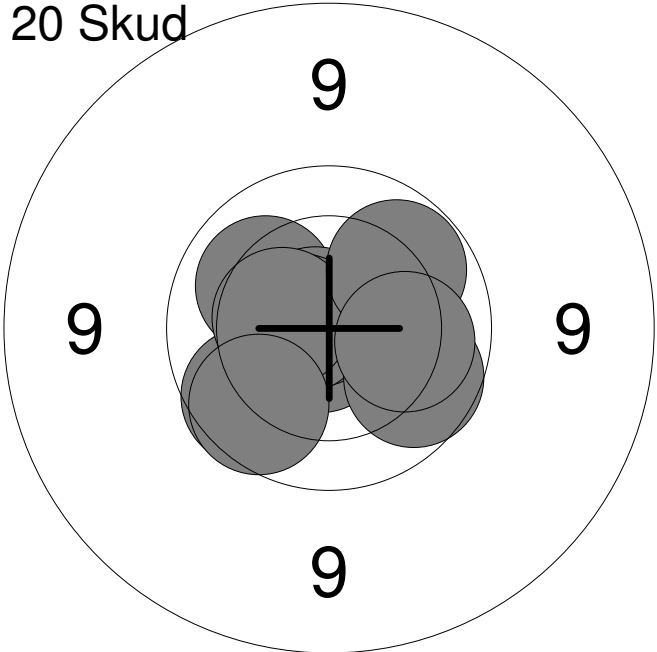
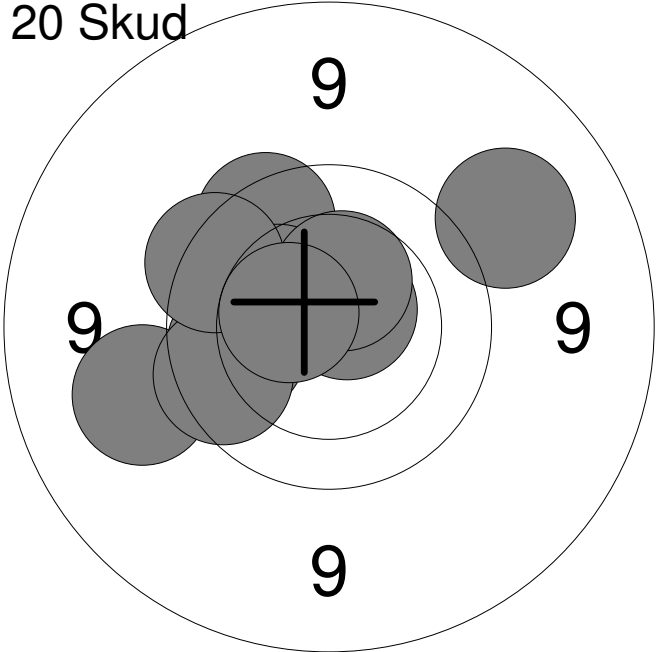

Hold <b>19</b>	Skive <b>2</b>	<b>Frederik H. Andersen</b>	
15m	Skf. Kimbrene	J2	
30.01.2015	Nordjysk mesterskab 2015	Aalborg Skyttekreds	
Prøve 	1:	10.2	↗
	2:	9.9	↖
	3:	9.8	↖
	4:	9.9	↘
	5:	9.9	↖
	6:	10.5	↘
	7:	9.9	↖
	<b>Serie</b>	<b>65.0</b>	
	<b>Total</b>	<b>0.0</b>	
20 Skud 	1:	10.8x	↘
	2:	9.9	↖
	3:	10.1	↗
	4:	10.8x	↗
	5:	10.6x	↖
	6:	10.4	↖
	7:	10.0	↗
	8:	9.9	↘
	9:	10.1	↗
	10:	9.9	↘
	<b>Serie</b>	<b>97.0</b>	
	<b>Total</b>	<b>97.0</b>	
20 Skud 	11:	9.8	↗
	12:	10.7x	↗
	13:	9.3	↖
	14:	10.3	↗
	15:	9.2	↗
	16:	9.9	↖
	17:	10.4	↗
	18:	9.8	↖
	19:	9.7	↗
	20:	10.5	↖
	<b>Serie</b>	<b>94.0</b>	
	<b>Total</b>	<b>191.0</b>	

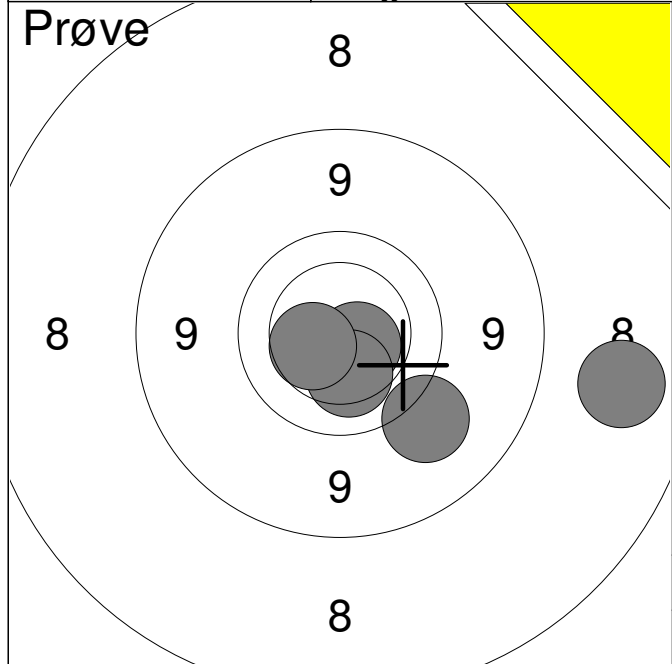

1:	9.3	↘
2:	8.2	→
3:	10.6x	↘
4:	10.2	↘
5:	10.4	↙
<b>Serie</b>		<b>47.0</b>
<b>Total</b>		<b>0.0</b>

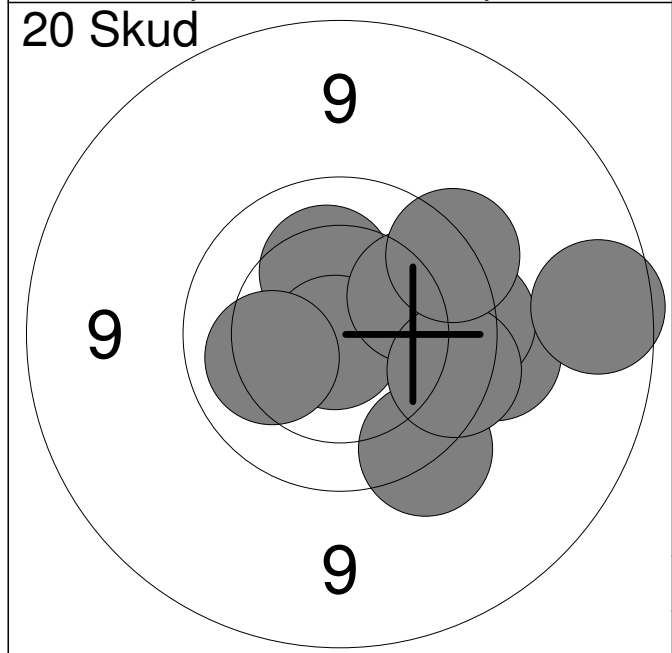

1:	10.2	↑
2:	10.8x	↘
3:	9.5	→
4:	10.1	←
5:	9.6	↘
6:	9.7	→
7:	8.9	→
8:	10.0	↗
9:	9.8	→
10:	9.6	↗
<b>Serie</b>		<b>93.0</b>
<b>Total</b>		<b>93.0</b>

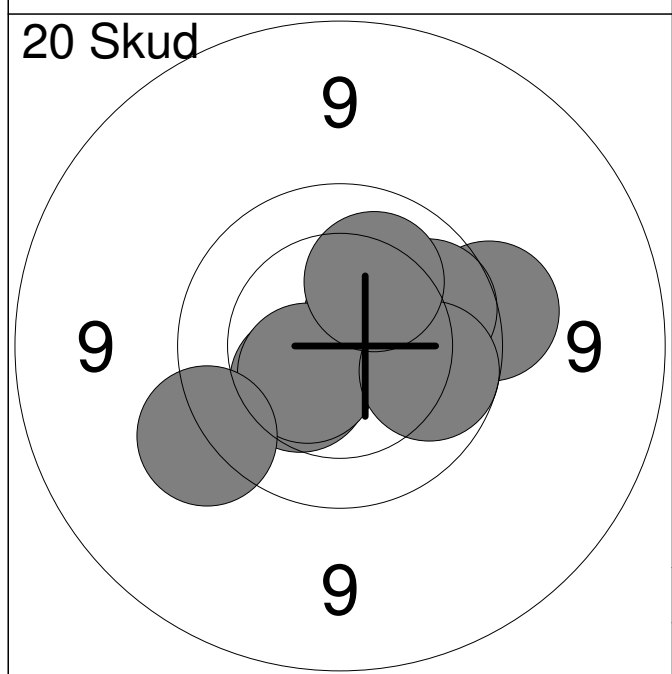

11:	10.0	→
12:	10.5x	↗
13:	9.9	→
14:	9.6	→
15:	10.4	↘
16:	9.9	↗
17:	10.5x	↘
18:	9.9	→
19:	10.2	↑
20:	9.5	↙
<b>Serie</b>		<b>95.0</b>
<b>Total</b>		<b>188.0</b>

Hold <b>19</b>	Skive <b>4</b>	<b>Tobias Engberg Hansen</b>	
-------------------	-------------------	------------------------------	--

15m	Løgstør Sportsskytteklub	MJ1	
-----	--------------------------	-----	--

30.01.2015	Nordjysk mesterskab 2015	Aalborg Skyttekreds	
------------	--------------------------	---------------------	--

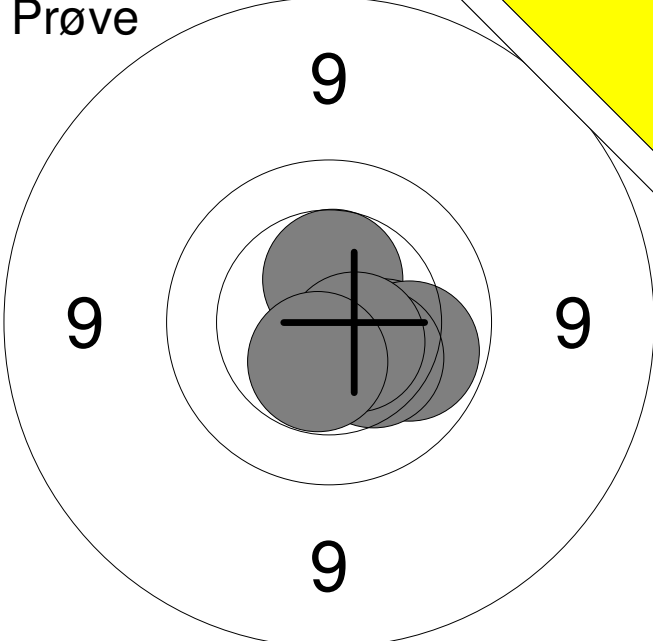
<b>Prøve</b> 	1: 10.5	↑
	2: 10.3	↘
	3: 10.0	↘
	4: 10.3	↘
	5: 10.6x	↘
	6: 10.5x	↘
<b>Serie</b>		<b>60.0</b>
<b>Total</b>		<b>0.0</b>

<b>20 Skud</b> 	1: 10.2	↘
	2: 10.5x	↘
	3: 10.5x	↘
	4: 10.4	→
	5: 10.6x	→
	6: 10.8x	↗
	7: 10.4	↑
	8: 10.6x	↗
	9: 10.5x	↘
	10: 10.6x	↗
<b>Serie</b>		<b>100.0</b>
<b>Total</b>		<b>100.0</b>

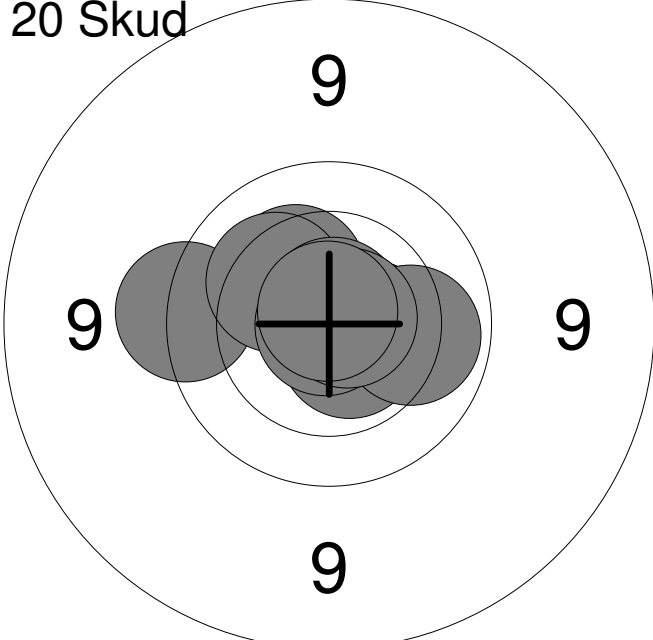
<b>20 Skud</b> 	11: 10.3	↗
	12: 9.6	←
	13: 10.5x	→
	14: 10.2	↗
	15: 10.8x	↗
	16: 10.6x	↘
	17: 10.9x	←
	18: 10.1	→
	19: 10.7x	→
	20: 10.8x	↑
<b>Serie</b>		<b>99.0</b>
<b>Total</b>		<b>199.0</b>

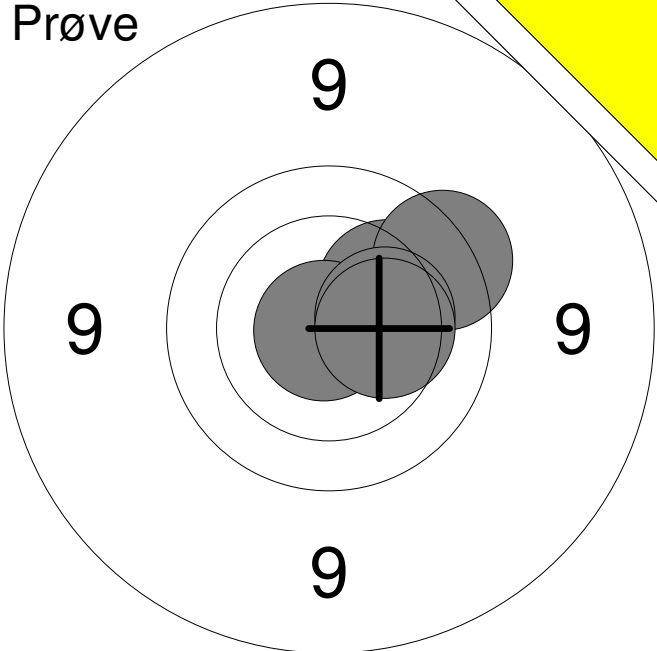
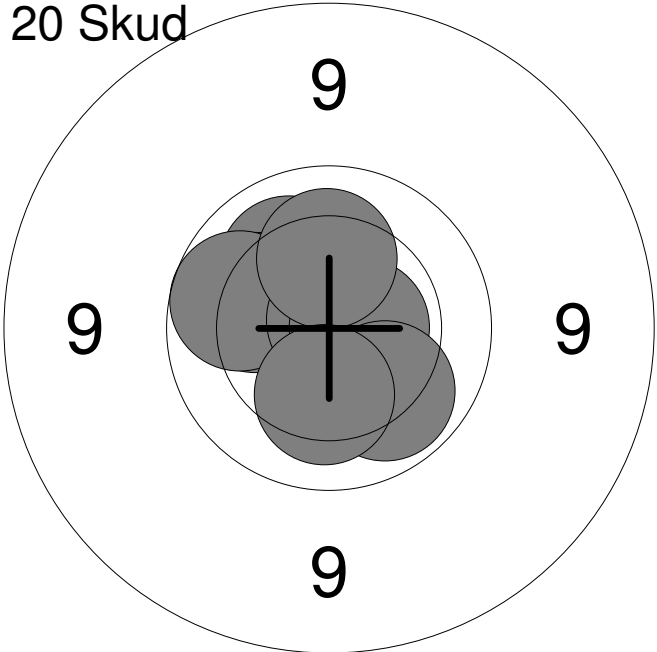
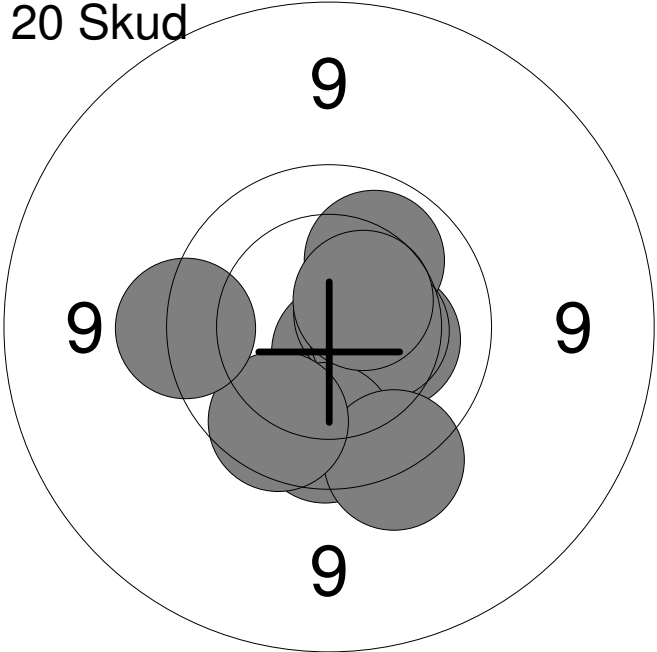
Hold	Skive	Frederik B. Sørensen	
19	5	Løgstør Sportsskytteklub	MJ1
15m			
30.01.2015	Nordjysk mesterskab 2015	Aalborg Skyttekreds	
Prøve		1: 10.2 →	
		2: 9.7 →	
		3: 10.9x ←	
		4: 10.3 →	
		5: 10.3 →	
	Serie	49.0	
	Total	0.0	
20 Skud		1: 10.1 →	
		2: 10.7x →	
		3: 10.1 →	
		4: 10.4 ↓	
		5: 9.9 ←	
		6: 10.8x →	
		7: 10.6x →	
		8: 10.2 ↑	
		9: 10.0 ↓	
		10: 10.2 ↓	
	Serie	99.0	
	Total	99.0	
20 Skud		11: 10.6x ↓	
		12: 10.3 →	
		13: 10.5x →	
		14: 10.1 ↗	
		15: 10.4 →	
		16: 9.9 ↓	
		17: 10.5 ↗	
		18: 9.6 ↓	
		19: 9.9 ↓	
		20: 9.6 ←	
	Serie	96.0	
	Total	195.0	

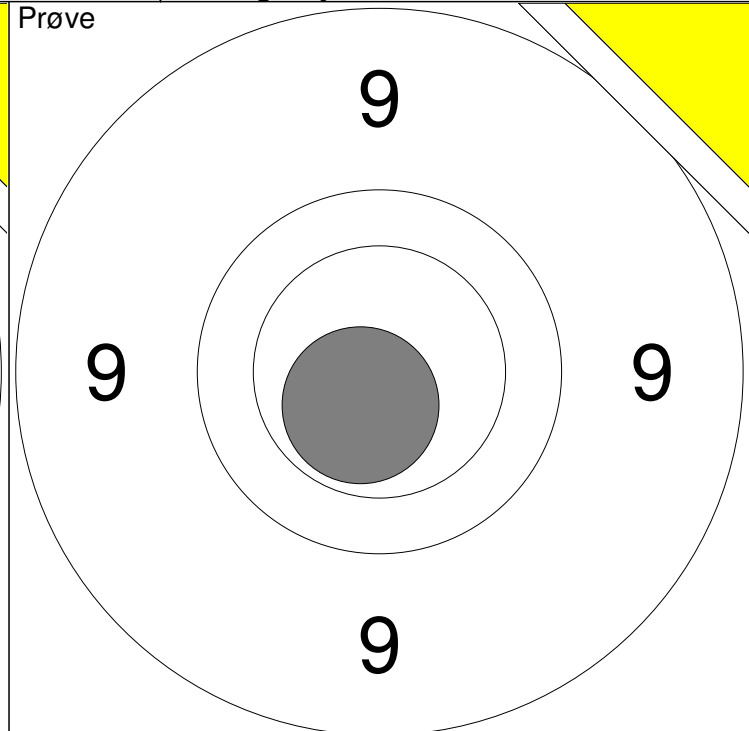
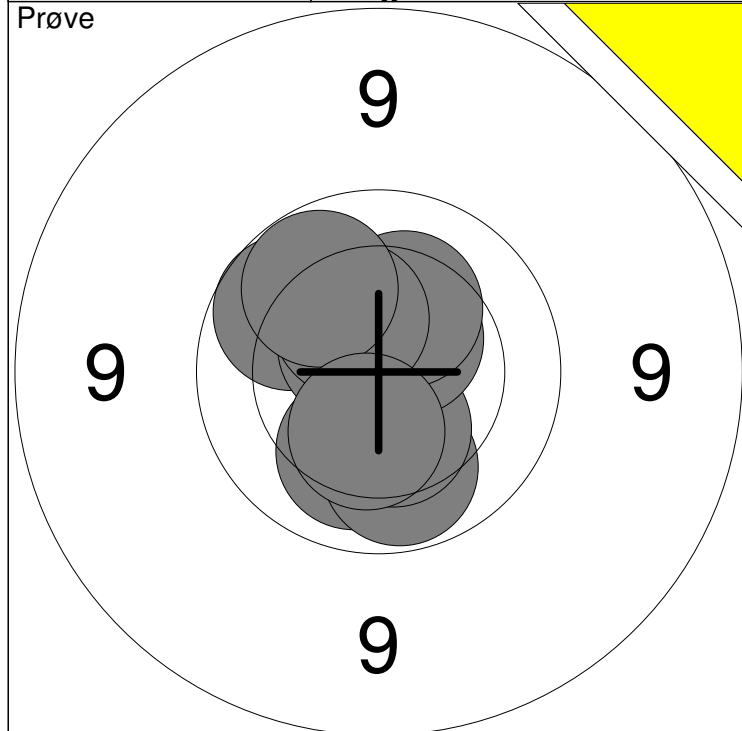

1: 9.9 ↗	6: 10.5x ↗	Serie	99
2: 10.1 ↓	7: 10.3 ↗		
3: 10.0 ↓	8: 10.4 ↗	Total	0
4: 10.4 ↓	9: 10.0 ↗		
5: 10.6x ↗	10: 10.4 ↓		

11: 10.6x ↘	Serie	10
	Total	0

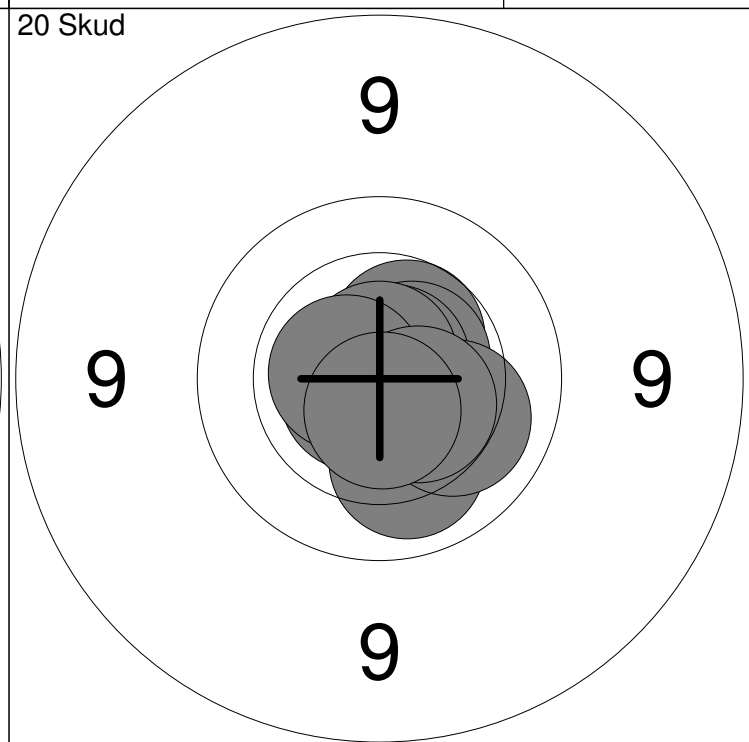
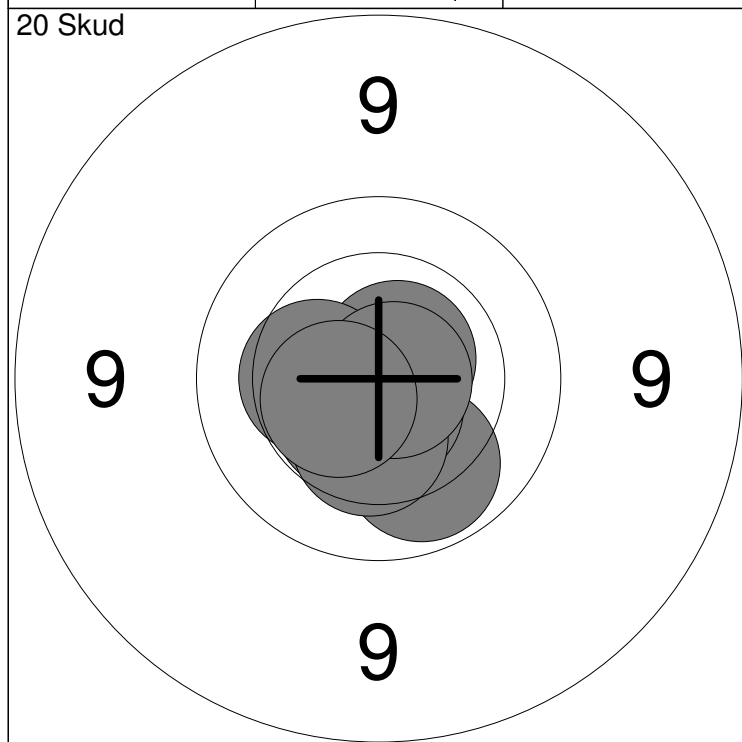

1: 10.0 ↓	6: 10.5x ↘	Serie	100
2: 10.7x ↓	7: 10.4 ↓		
3: 10.7x ↗	8: 10.4 ←	Total	100
4: 10.6x ↙	9: 10.8x →		
5: 10.5x ←	10: 10.5x ↙		

11: 10.1 ↓	16: 10.8x ↑	Serie	100
12: 10.5 ↗	17: 10.6x ←		
13: 10.6x ↗	18: 10.1 ↓	Total	200
14: 10.8x ↗	19: 10.5x ↘		
15: 10.7x ↙	20: 10.6x ↓		

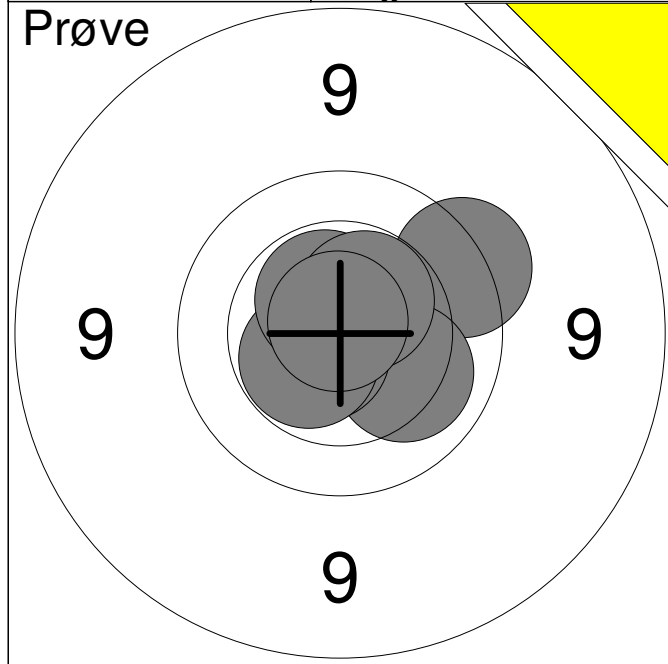

1:	9.7	↗
2:	10.1	→
3:	10.7x	↙
4:	10.5x	↙
5:	10.6x	↗
6:	10.5x	↗
7:	10.8x	↗
<b>Serie</b>		<b>69.0</b>
<b>Total</b>		<b>0.0</b>

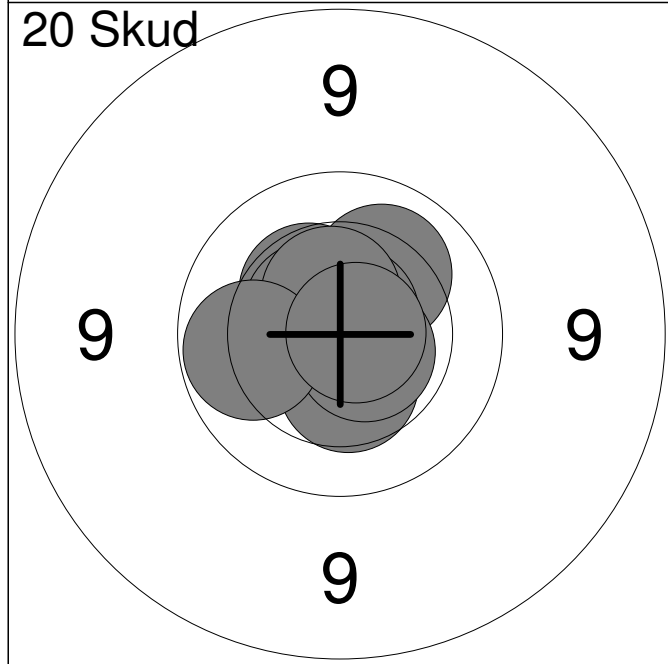

1:	10.4	↗
2:	10.7x	↗
3:	10.4	↘
4:	10.2	↗
5:	10.6x	↘
6:	10.6x	↗
7:	10.7x	↗
8:	10.5x	↗
9:	10.0	←
10:	10.8x	→
<b>Serie</b>		<b>100.0</b>
<b>Total</b>		<b>100.0</b>

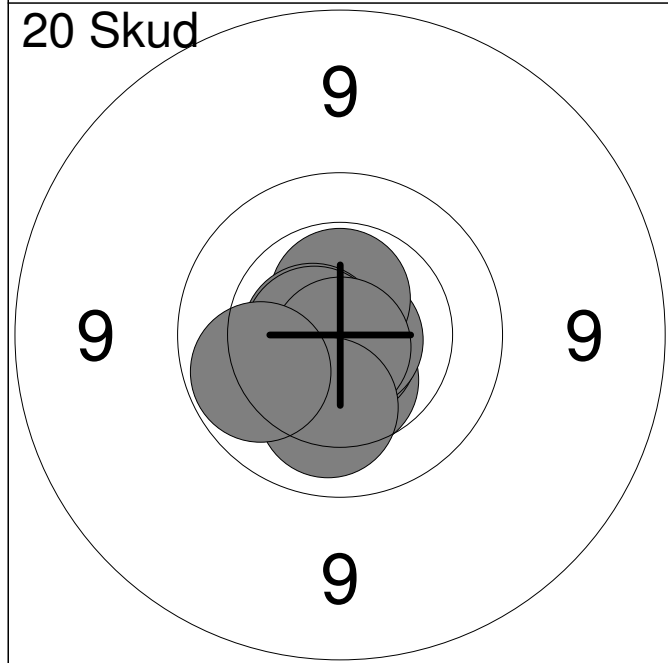

11:	10.5	↘
12:	10.7x	↙
13:	10.8x	↘
14:	10.8x	→
15:	10.6x	↗
16:	10.7x	←
17:	10.7x	←
18:	10.8x	↘
19:	10.2	↘
20:	10.0	↙
<b>Serie</b>		<b>100.0</b>
<b>Total</b>		<b>200.0</b>

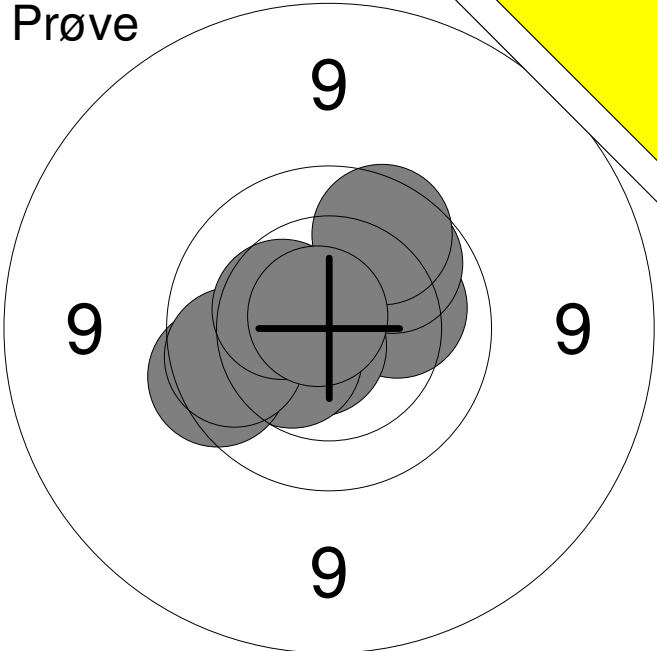
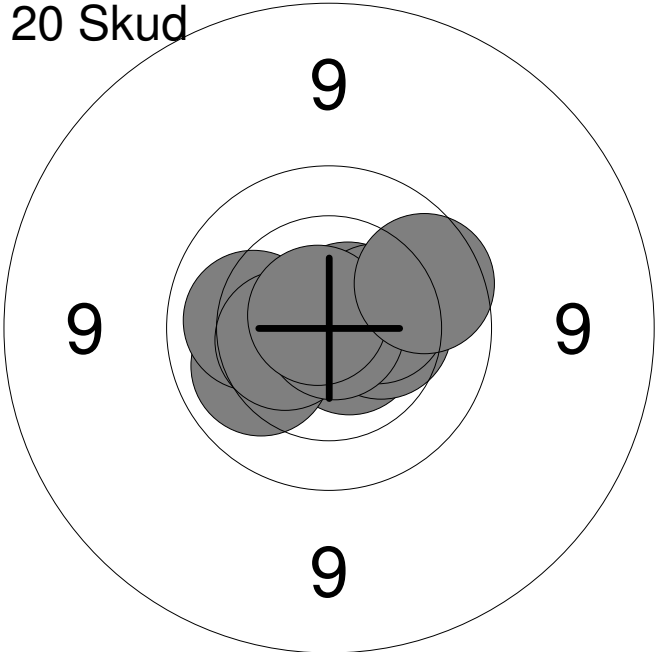
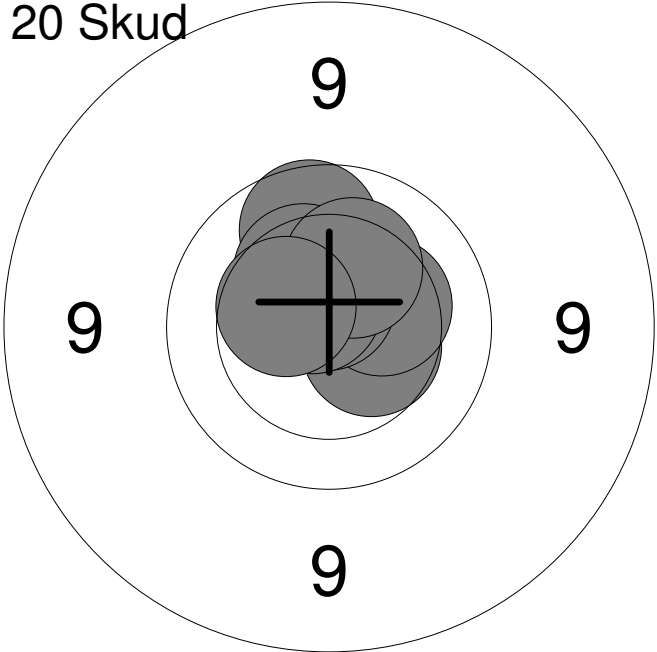
Hold <b>19</b>	Skive <b>8</b>	<b>Christian P. W. Thomsen</b>	
15m	Lindholm Sports Skytte Klub	BK2	
30.01.2015	Nordjysk mesterskab 2015	Aalborg Skyttekreds	
Prøve 	1:	10.2	→
	2:	10.7x	↙
	3:	10.4	↙
	4:	9.8	↙
	5:	9.9	←
	6:	10.4	↖
	7:	10.0	↗
	8:	9.9	↗
	9:	10.8x	↗
	<b>Serie</b>	<b>87.0</b>	
	<b>Total</b>	<b>0.0</b>	
20 Skud 	1:	10.7x	↘
	2:	10.4	→
	3:	10.1	↙
	4:	10.1	←
	5:	10.7x	↗
	6:	10.4	→
	7:	10.5	←
	8:	10.9x	→
	9:	10.8x	↗
	10:	9.9	→
	<b>Serie</b>	<b>99.0</b>	
	<b>Total</b>	<b>99.0</b>	
20 Skud 	11:	9.9	↑
	12:	10.4	→
	13:	10.5x	↑
	14:	10.4	↑
	15:	10.3	↗
	16:	10.3	→
	17:	10.7x	↑
	18:	10.6x	↗
	19:	10.3	↗
	20:	10.4	↖
	<b>Serie</b>	<b>99.0</b>	
	<b>Total</b>	<b>198.0</b>	

Hold <b>19</b>	Skive <b>9</b>	<b>Magnus Bisgaard Larsen</b>	
-------------------	-------------------	-------------------------------	--

15m	Vilsted Skf.	MB2	
-----	--------------	-----	--

30.01.2015	Nordjysk mesterskab 2015	Aalborg Skyttekreds
------------	--------------------------	---------------------

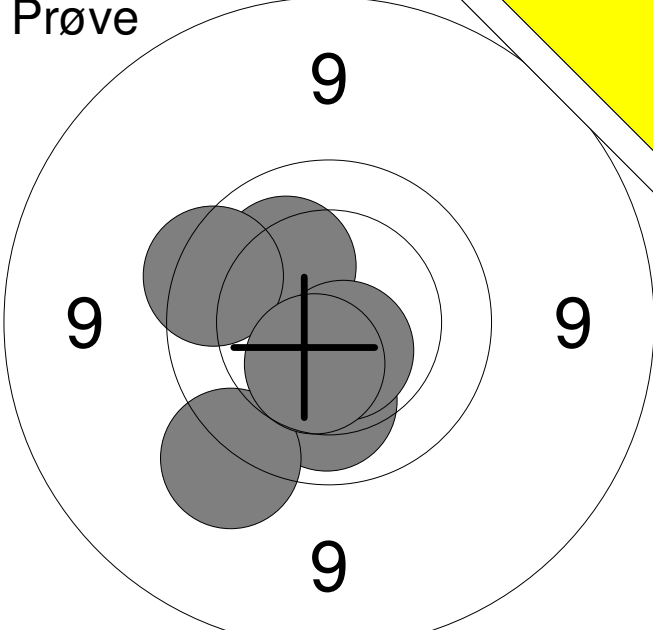
<b>Prøve</b> 	1: 10.1	↓
	2: 9.5	↙
	3: 10.2	↗
	4: 9.8	↗
	5: 10.6x	↓
	6: 10.5	↓
<b>Serie</b>	<b>58.0</b>	
<b>Total</b>	<b>0.0</b>	

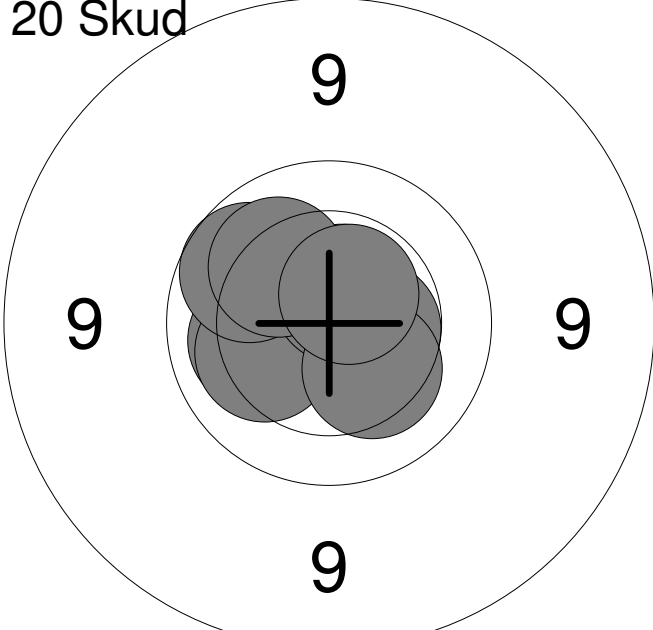
<b>20 Skud</b> 	1: 10.8x	↙
	2: 10.9x	↓
	3: 10.2	←
	4: 10.2	←
	5: 10.5x	→
	6: 10.6x	↗
	7: 9.9	↗
	8: 10.3	↓
	9: 10.1	↗
	10: 10.6x	↗
<b>Serie</b>	<b>99.0</b>	
<b>Total</b>	<b>99.0</b>	

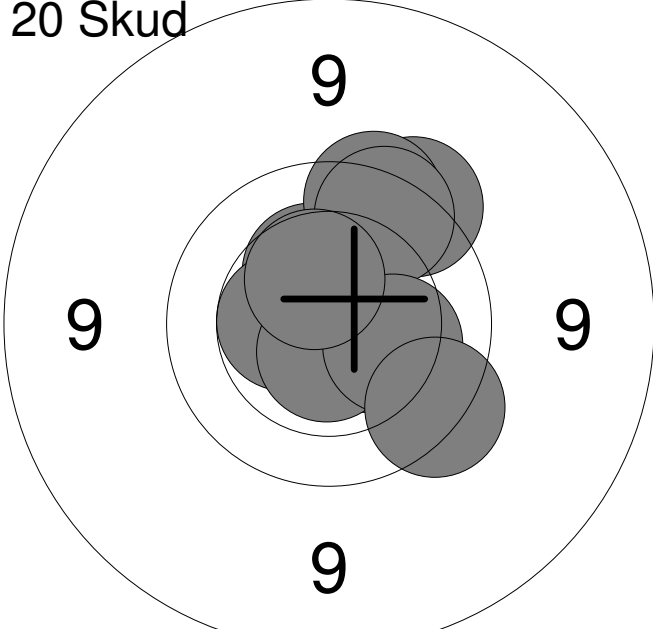
<b>20 Skud</b> 	11: 10.4	↗
	12: 9.6	↗
	13: 9.7	↗
	14: 9.8	↗
	15: 10.5x	↘
	16: 10.5	←
	17: 10.6x	↓
	18: 10.2	→
	19: 10.4	↗
	20: 9.7	↓
<b>Serie</b>	<b>96.0</b>	
<b>Total</b>	<b>195.0</b>	



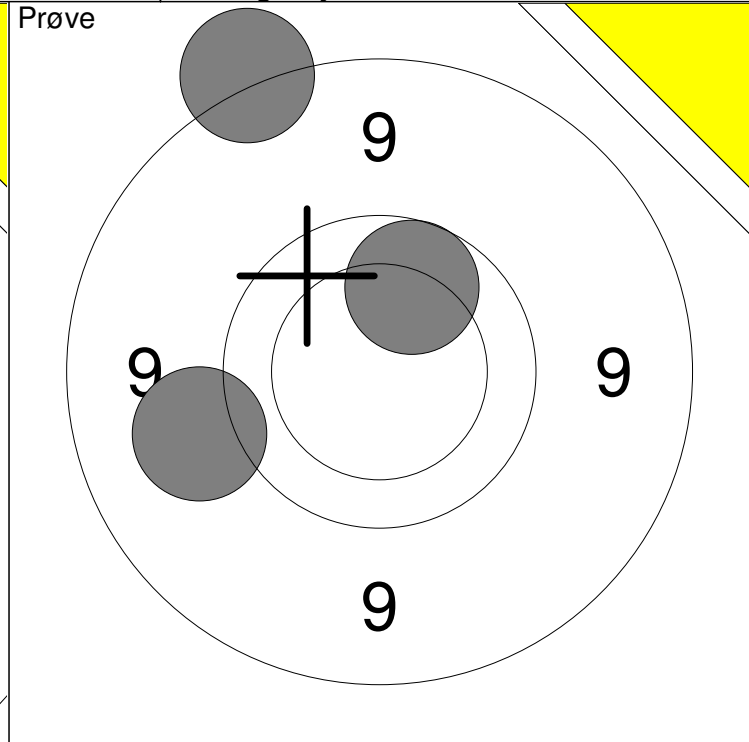
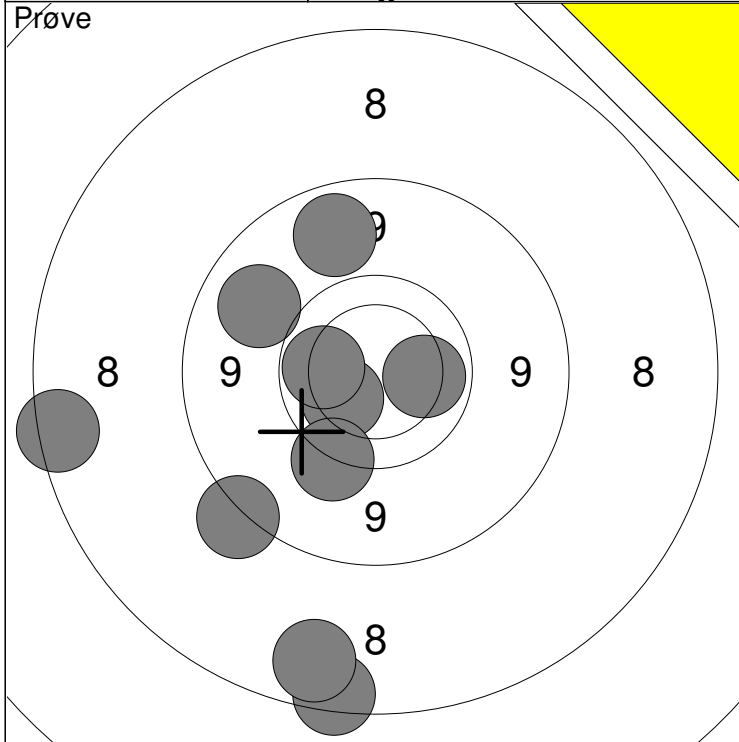

1: 7.8 ↓	6: 9.0 ↑	Serie	87
2: 8.0 ↓	7: 9.1 ↖		
3: 10.2 ↙	8: 8.6 ↘	Total	0
4: 10.1 →	9: 10.0 ←		
5: 9.5 ↘	10: 7.8 ←		

11: 9.3 ←	Serie	26
12: 8.6 ↗		
13: 9.9 ↗	Total	0

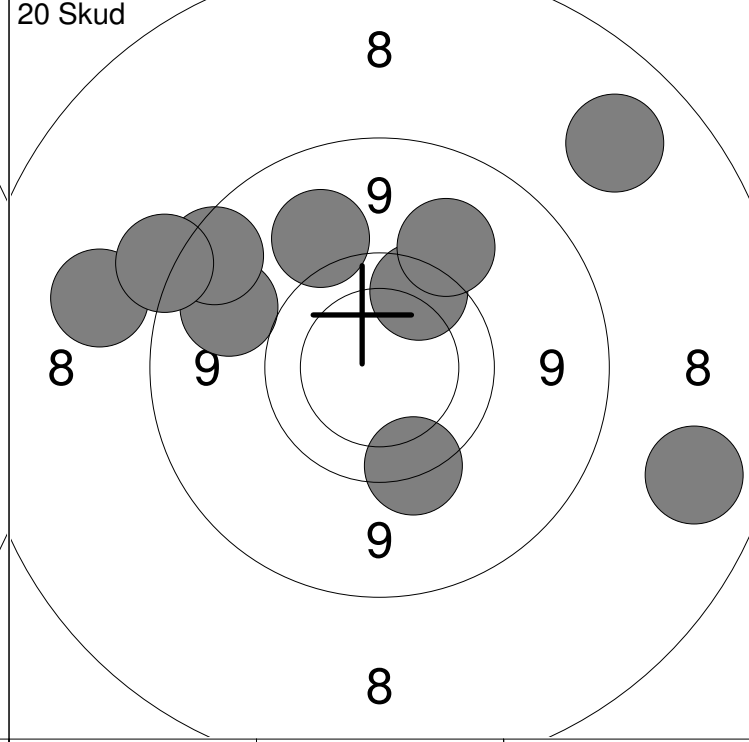
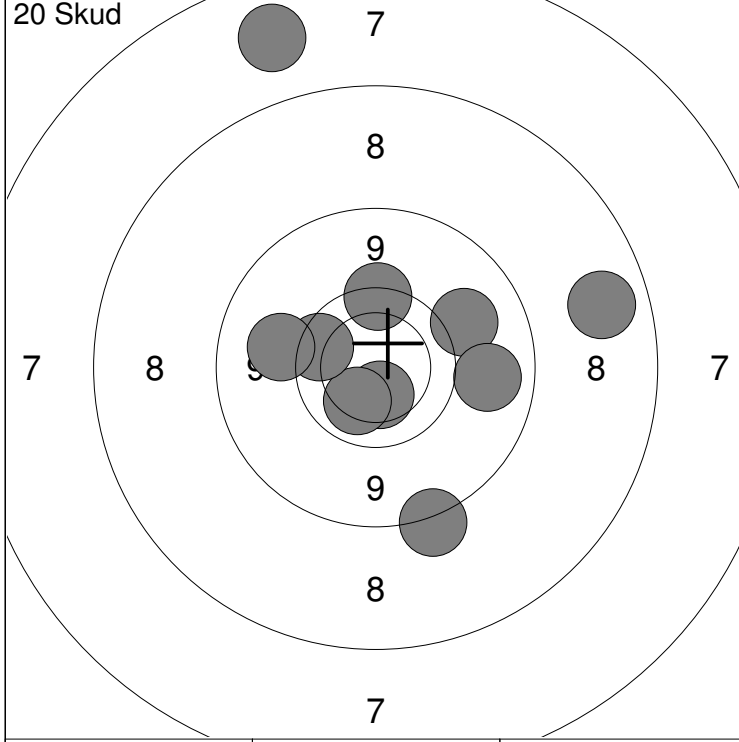

1: 9.3 ↗	6: 9.6 ↑	Serie	88
2: 10.3 ↓	7: 9.3 ←		
3: 10.1 ↘	8: 9.1 →	Total	88
4: 7.2 ↗	9: 8.6 ↘		
5: 9.8 ←	10: 8.1 →		

11: 9.6 ↓	16: 8.1 →	Serie	85
12: 9.1 ←	17: 8.1 ↗		
13: 8.3 ←	18: 8.6 ↖	Total	173
14: 9.8 ↗	19: 9.3 ↗		
15: 8.8 ↖	20: 9.3 ↗		

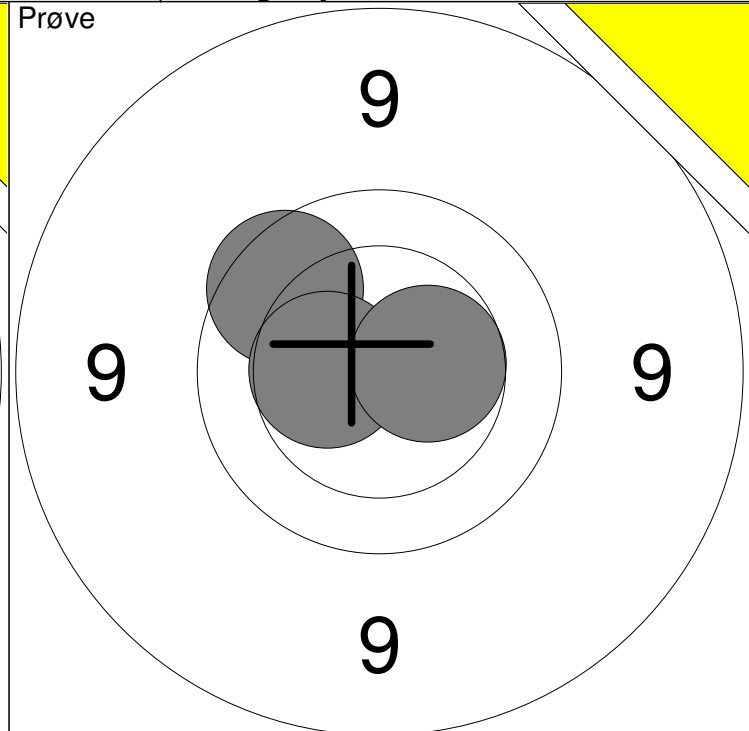
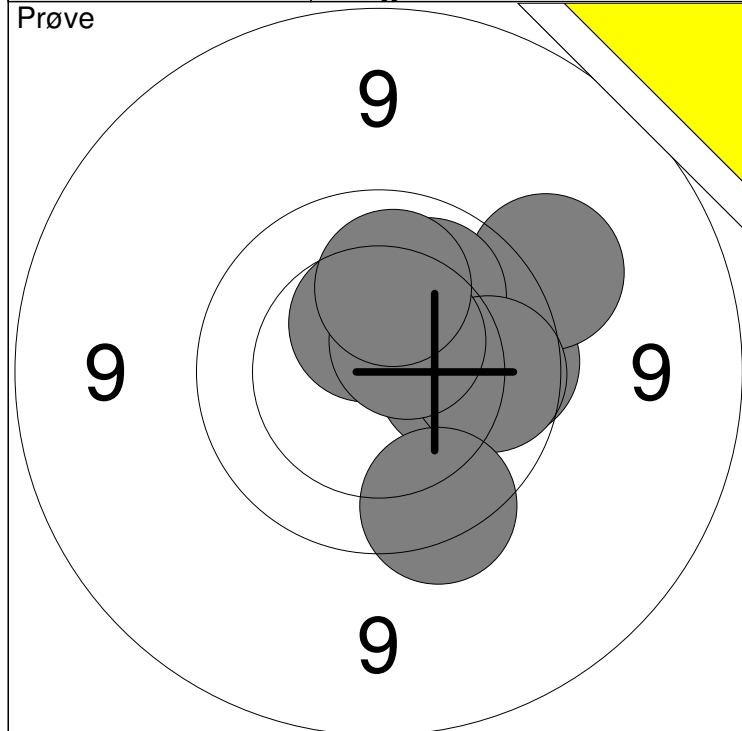

1: 10.5 ↗	6: 10.1 ↗	Serie	96
2: 10.2 ↗	7: 9.9 →		
3: 10.2 →	8: 9.7 ↘	Total	0
4: 9.8 →	9: 10.5x ↗		
5: 9.5 ↗	10: 10.1 ↗		

11: 9.8 ↗	Serie	29
12: 10.4 ←		
13: 10.5 →	Total	0

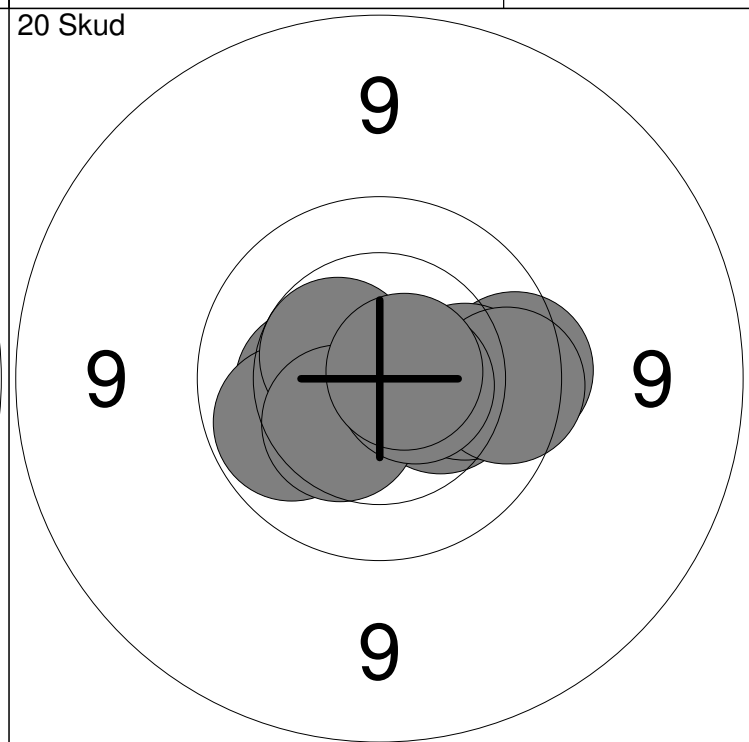
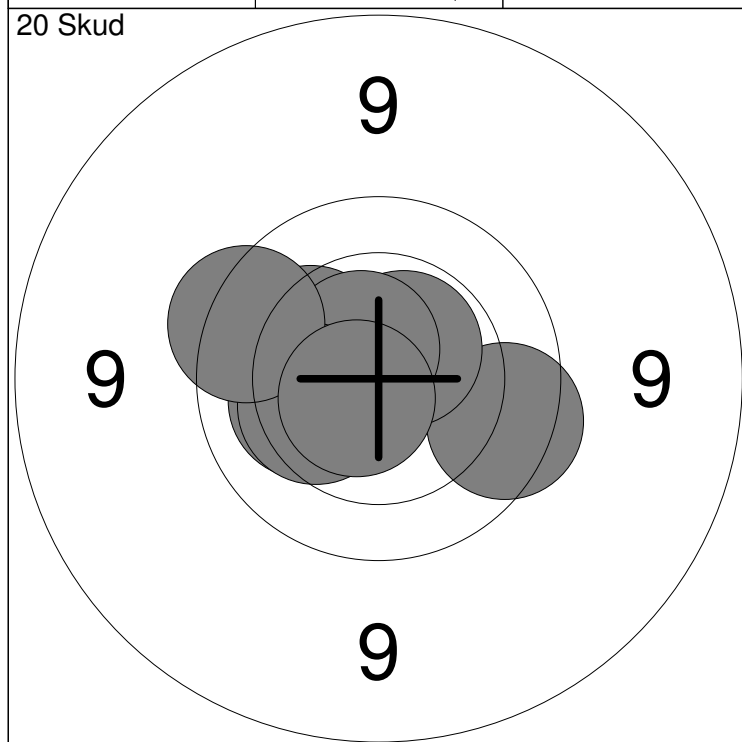

1: 9.8 →	6: 10.6x ↗	Serie	98
2: 10.2 ↗	7: 10.2 ←		
3: 10.6x ←	8: 10.3 ←	Total	98
4: 10.8x ←	9: 9.7 ←		
5: 10.6x ↗	10: 10.7x ↘		

11: 10.3 →	16: 9.8 →	Serie	98
12: 10.3 ←	17: 10.1 →		
13: 10.0 ←	18: 9.8 →	Total	196
14: 10.5 ↗	19: 10.6x →		
15: 10.4 ↘	20: 10.7x →		

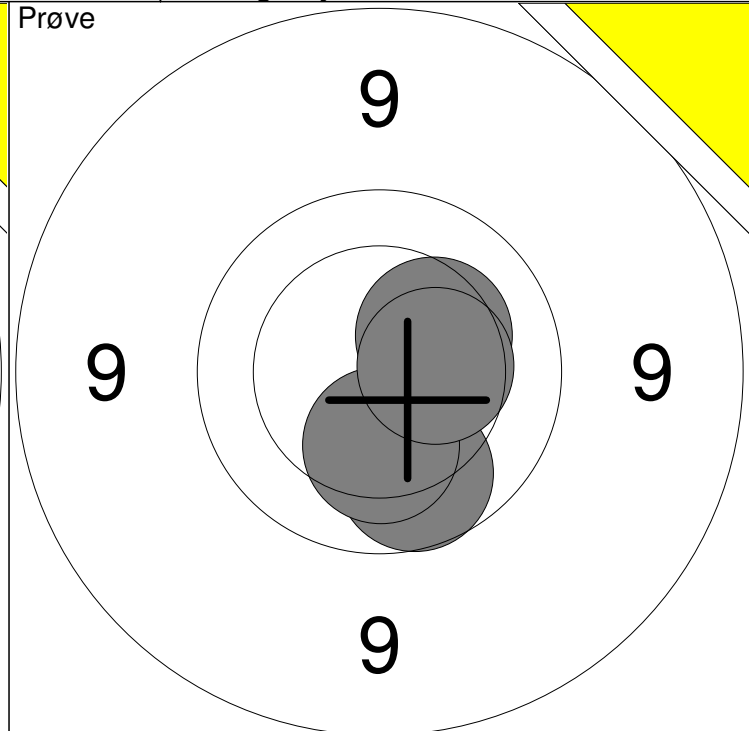
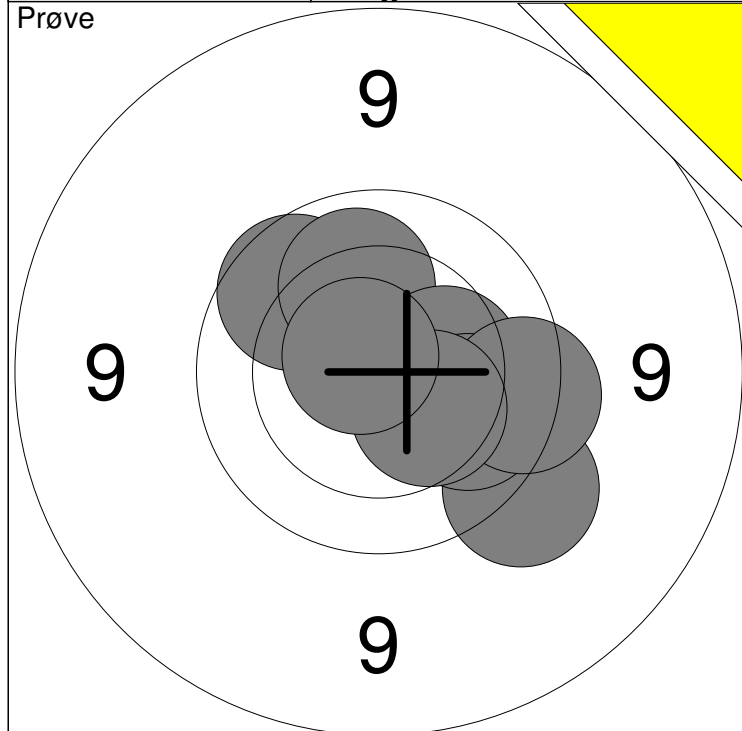

1: 9.5 ↘	6: 10.3 →	Serie	97
2: 10.1 →	7: 10.0 ↘		
3: 9.9 ↗	8: 9.7 →	Total	0
4: 10.1 ↗	9: 10.4 ↘		
5: 10.5 →	10: 10.7x ↗		

11: 9.9 ↘	Serie	39
12: 10.3 ↗		
13: 10.2 ↘	Total	0
14: 10.4 →		

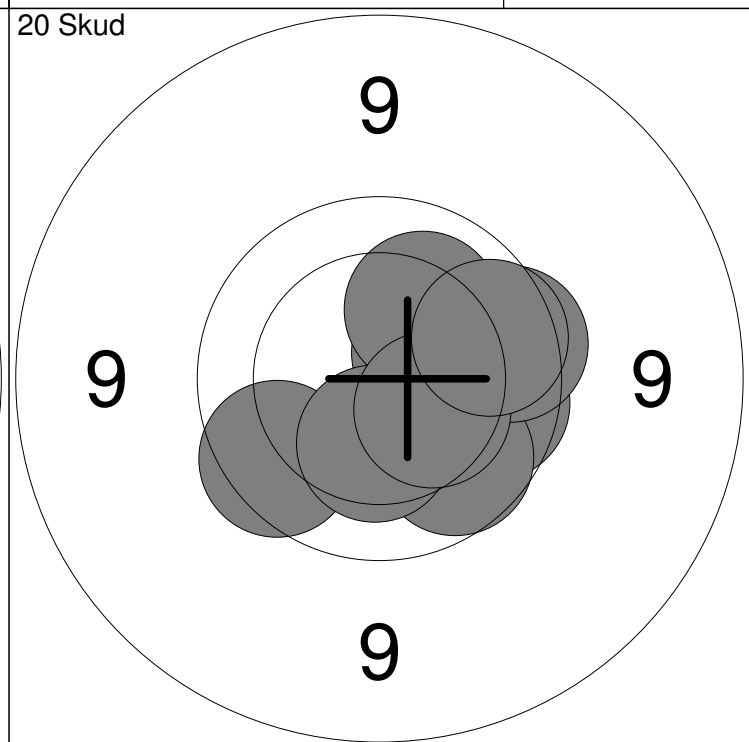
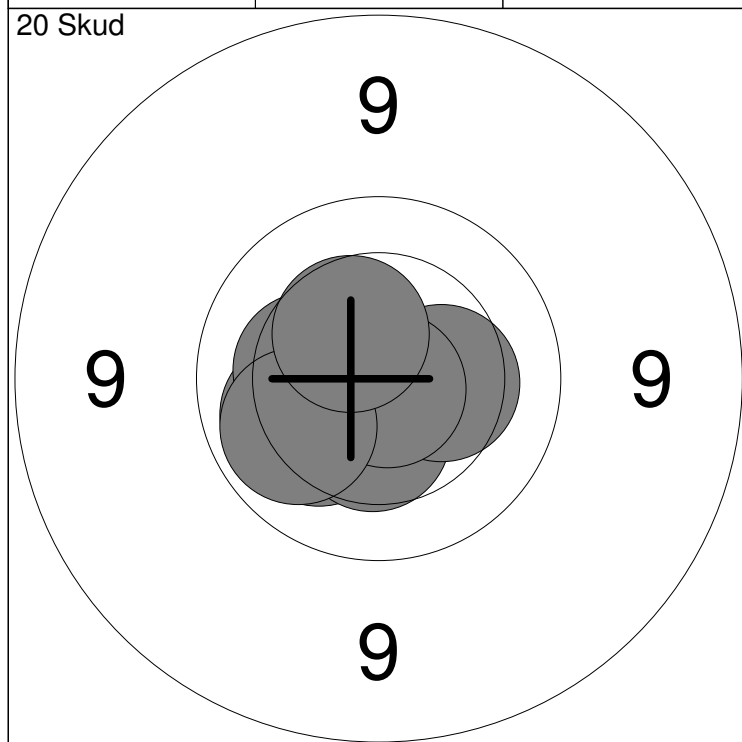

1: 10.2 ↖	6: 10.3 →	Serie	100
2: 10.5x ↗	7: 10.3 ←		
3: 10.8x ↗	8: 10.8x ↘	Total	100
4: 10.1 ↖	9: 10.0 ←		
5: 10.4 ↓	10: 10.4 ↗		

11: 10.4 ↗	16: 10.3 ↓	Serie	95
12: 9.8 ↖	17: 10.2 ↗		
13: 9.9 →	18: 9.8 →	Total	195
14: 9.9 ↘	19: 10.4 ↘		
15: 10.2 →	20: 9.9 ↗		

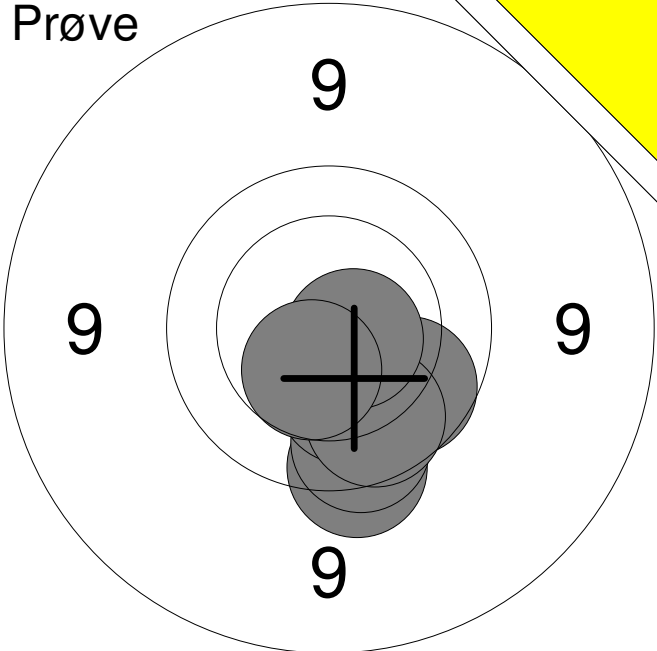
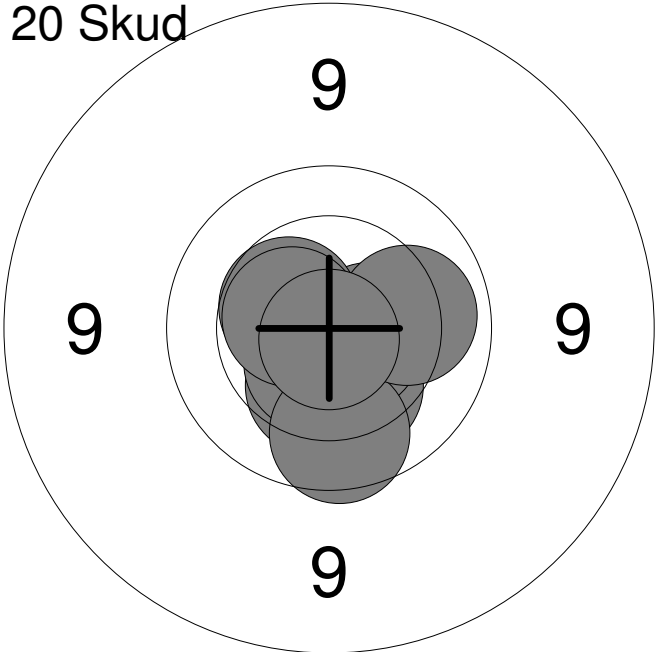
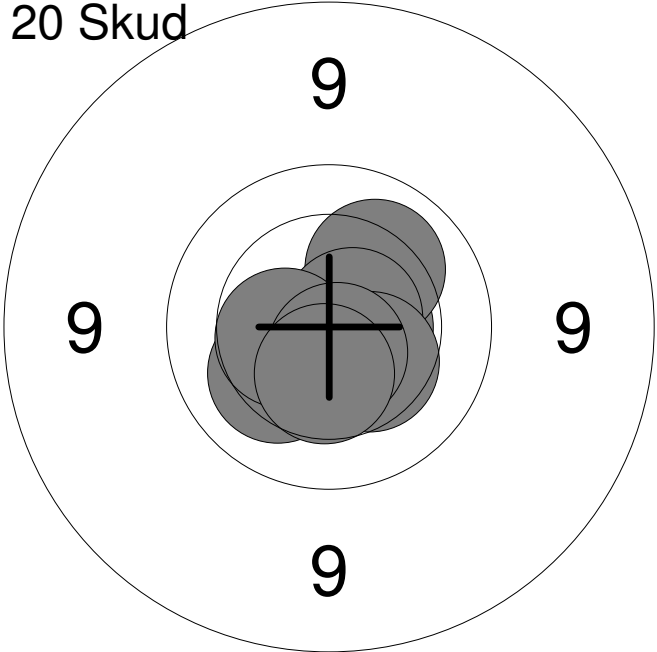
Hold <b>20</b>	Skive <b>3</b>	<b>Sebastian Johansen</b>	
15m	Løgstør Sportsskytteklub	MB4	
30.01.2015	Nordjysk mesterskab 2015	Aalborg Skyttekreds	
Prøve		1: 9.9 ↘	
		2: 10.1 ↘	
		3: 9.6 ↘	
		4: 9.8 ↘	
		5: 10.2 ↘	
		6: 10.5x ↘	
		7: 9.9 ↘	
		8: 10.7x ↘	
		9: 10.5 ↘	
		<b>Serie 86.0</b>	
		<b>Total 0.0</b>	
20 Skud		1: 10.5x →	
		2: 10.3 ↘	
		3: 10.3 ↘	
		4: 10.7x ↘	
		5: 10.5 ↗	
		6: 10.5x ↘	
		7: 9.9 ↘	
		8: 10.5x ↖	
		9: 10.1 →	
		10: 10.8x ↓	
		<b>Serie 99.0</b>	
		<b>Total 99.0</b>	
20 Skud		11: 10.6x →	
		12: 10.2 ↘	
		13: 10.2 ↗	
		14: 10.6x ↘	
		15: 10.7x →	
		16: 10.5 ↖	
		17: 10.6x ↘	
		18: 10.4 ↘	
		19: 10.7x ↘	
		20: 10.4 ↓	
		<b>Serie 100.0</b>	
		<b>Total 199.0</b>	

Hold <b>20</b>	Skive <b>6</b>	<b>Josephine M. Holm</b>
-------------------	-------------------	--------------------------

15m	Skf. Kimbreerne	MB2
-----	-----------------	-----

30.01.2015	Nordjysk mesterskab 2015	Aalborg Skyttekreds
------------	--------------------------	---------------------

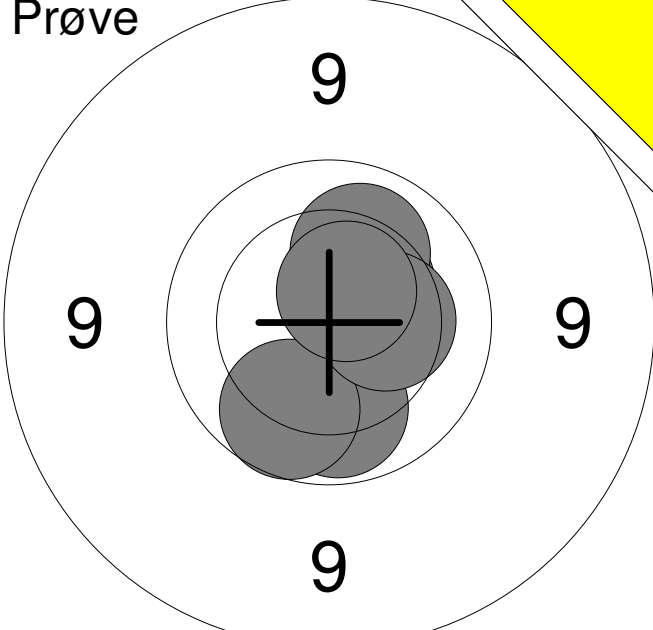
<b>Prøve</b> 	1: 10.4 ↗
	2: 10.1 ↑
	3: 10.0 ↓
	4: 9.9 ↓
	5: 10.3 →
	6: 10.6x ↑
<b>Serie</b>	<b>59.0</b>
<b>Total</b>	<b>0.0</b>

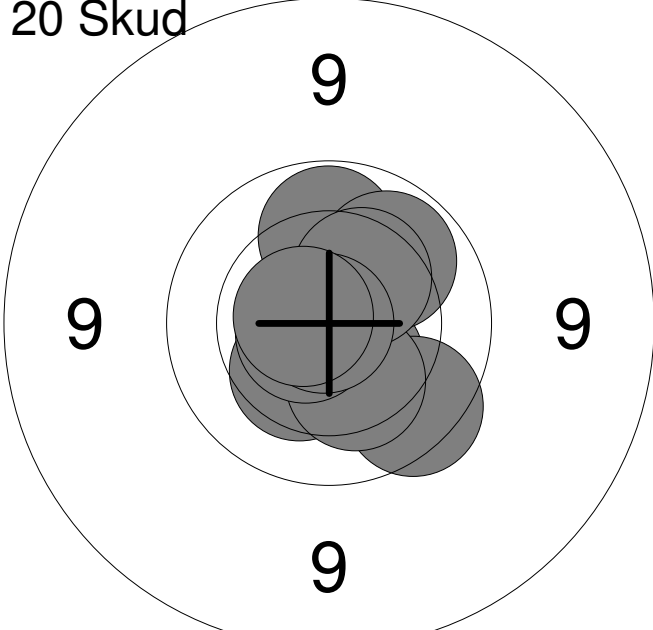
<b>20 Skud</b> 	1: 10.0 ↑
	2: 10.5 ↓
	3: 10.3 ↓
	4: 9.8 ↓
	5: 10.3 ↓
	6: 10.7x ←
	7: 10.0 ↗
	8: 10.3 ↗
	9: 10.9x ←
	10: 10.7x ←
<b>Serie</b>	<b>99.0</b>
<b>Total</b>	<b>99.0</b>

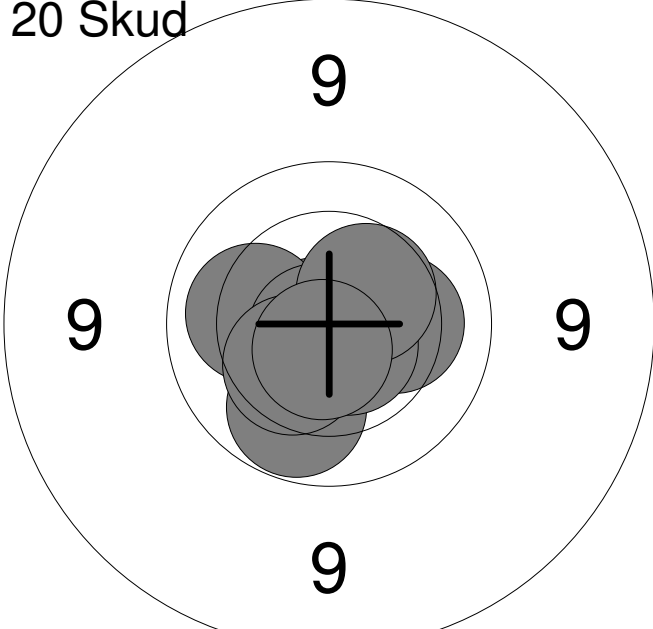
<b>20 Skud</b> 	11: 10.0 ↓
	12: 10.9x ↓
	13: 10.8x ←
	14: 10.2 →
	15: 10.2 ←
	16: 10.8x ↓
	17: 10.4 ↓
	18: 10.6x ↓
	19: 10.4 ↗
	20: 10.7x ↓
<b>Serie</b>	<b>100.0</b>
<b>Total</b>	<b>199.0</b>

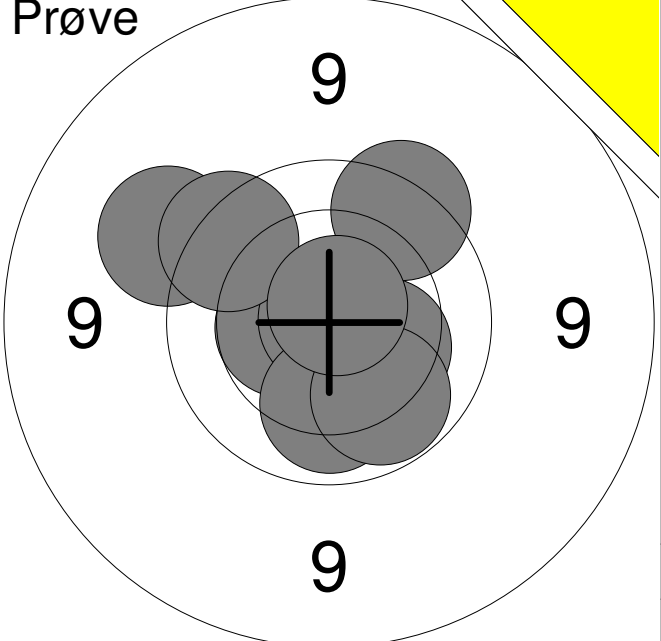
<b>Prøve</b> 	1: 9.7	↗
	2: 10.5	←
	3: 10.9x	↗
	4: 9.4	↗
	5: 10.3	↘
	6: 10.1	↓
	7: 9.7	↗
	8: 10.0	↘
	9: 10.8x	↗
	<b>Serie</b>	<b>87.0</b>
<b>Total</b>	<b>0.0</b>	

<b>20 Skud</b> 	1: 10.3	↗
	2: 10.3	←
	3: 9.5	↗
	4: 10.4	↘
	5: 8.9	↗
	6: 9.9	↗
	7: 9.2	↗
	8: 9.9	↗
	9: 9.6	↗
	10: 9.9	↗
<b>Serie</b>	<b>92.0</b>	
<b>Total</b>	<b>92.0</b>	

<b>20 Skud</b> 	11: 9.3	↗
	12: 8.5	↗
	13: 10.3	↘
	14: 9.4	↗
	15: 9.9	↗
	16: 9.1	↗
	17: 10.2	↘
	18: 9.8	↘
	19: 9.8	↘
	20: 9.5	←
<b>Serie</b>	<b>91.0</b>	
<b>Total</b>	<b>183.0</b>	

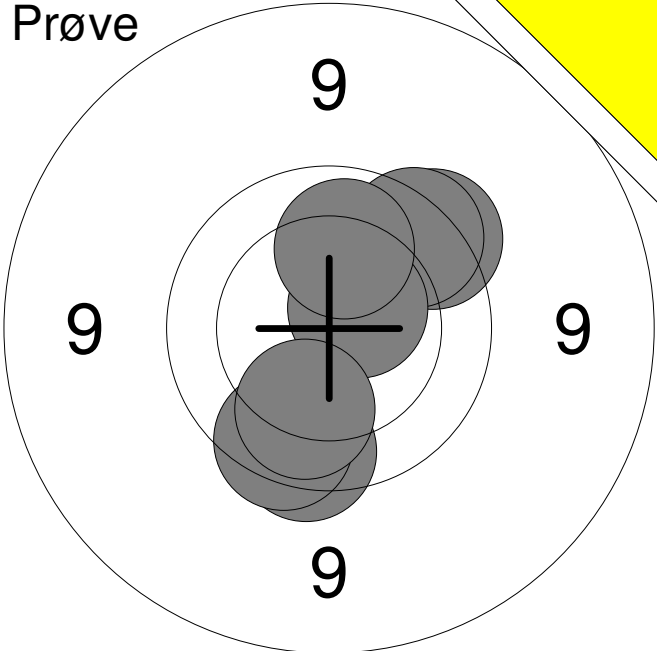
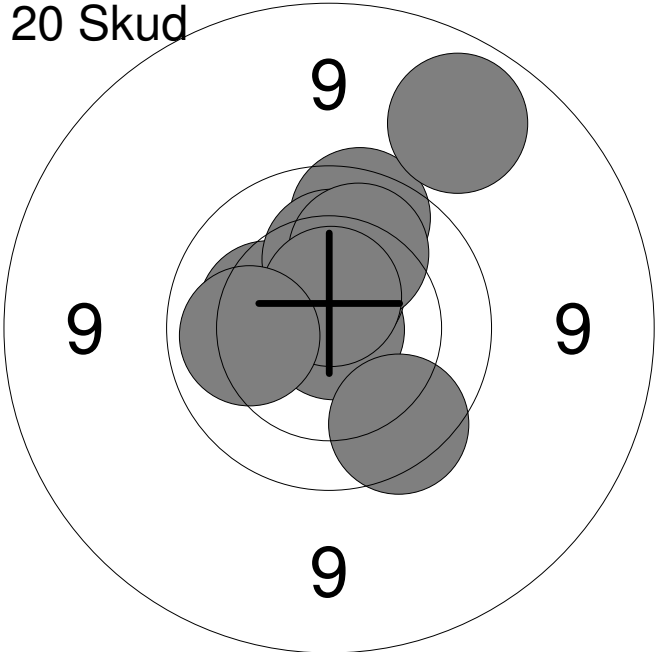
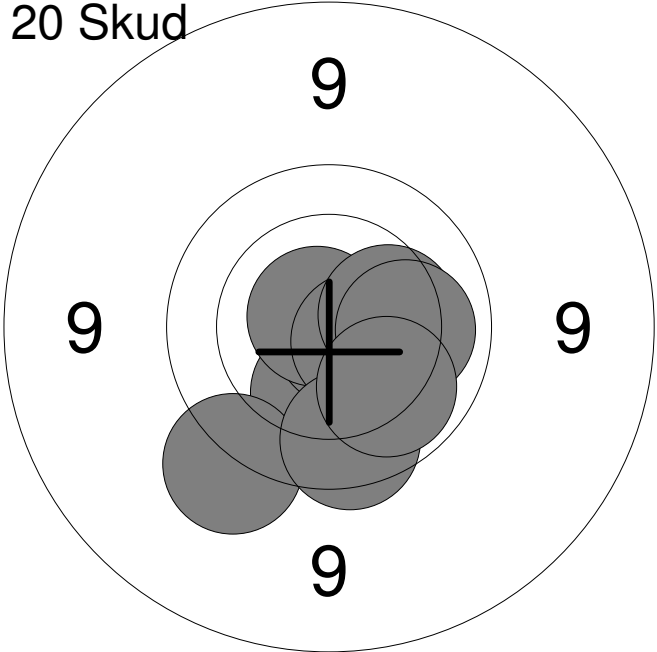
Hold <b>20</b>	Skive <b>9</b>	<b>Niclas Pedersen</b>	
15m	Vilsted Skf.	J2	
30.01.2015	Nordjysk mesterskab 2015	Aalborg Skyttekreds	
Prøve		1: 9.7	↓
		2: 9.7	↗
		3: 9.8	↗
		4: 10.6x	↗
		5: 9.8	↓
		6: 10.0	↓
		7: 10.1	↑
		<b>Serie</b>	<b>66.0</b>
		<b>Total</b>	<b>0.0</b>
20 Skud		1: 10.3	←
		2: 10.9x	→
		3: 9.8	↑
		4: 10.5x	↑
		5: 9.8	↓
		6: 10.2	↑
		7: 9.0	↗
		8: 10.1	↑
		9: 10.6x	↑
		10: 10.1	←
		<b>Serie</b>	<b>97.0</b>
		<b>Total</b>	<b>97.0</b>
20 Skud		11: 10.2	↓
		12: 10.8x	↓
		13: 10.8x	↗
		14: 10.3	→
		15: 9.5	↓
		16: 10.6x	↓
		17: 9.8	↓
		18: 10.3	→
		19: 10.1	→
		20: 10.0	↓
		<b>Serie</b>	<b>98.0</b>
		<b>Total</b>	<b>195.0</b>

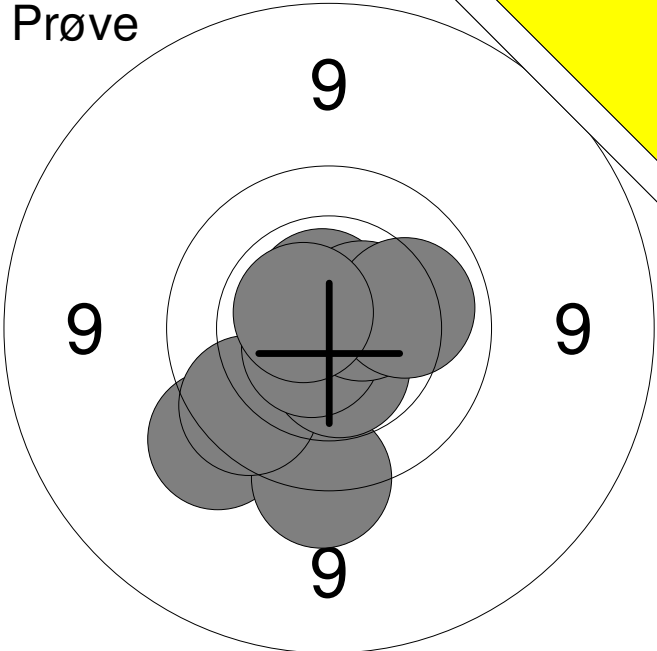
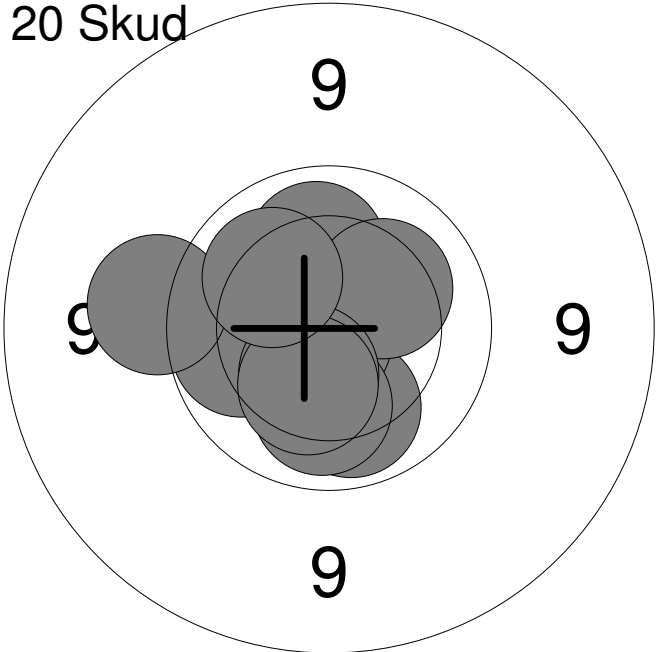
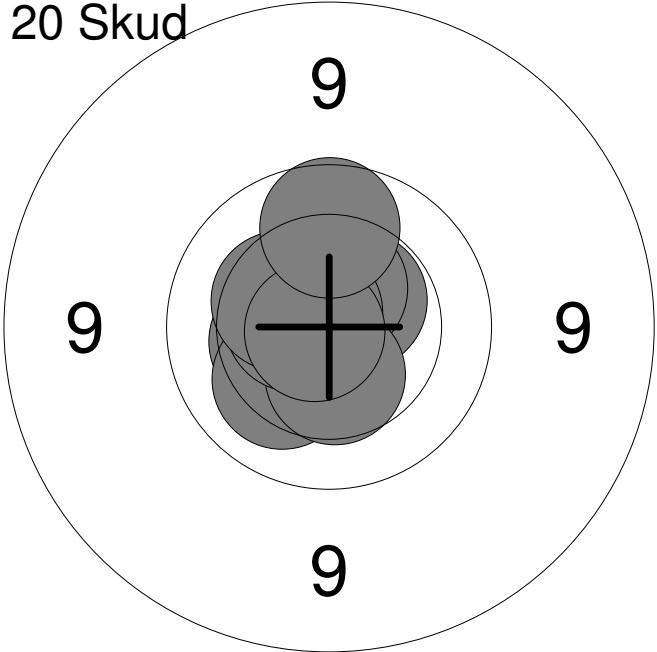
Hold	Skive	Sharun Knudsen	
20	10		
15m	Vilsted Skf.	BK4	
30.01.2015	Nordjysk mesterskab 2015	Aalborg Skyttekreds	
<b>Prøve</b> 	1:	10.6x	↙
	2:	9.6	↙
	3:	9.6	↓
	4:	9.8	↙
	5:	10.5x	↓
	6:	10.7x	↙
	7:	10.6x	↑
	8:	10.5x	→
	9:	10.1	→
	10:	10.6x	↖
	<b>Serie</b>		<b>97.0</b>
<b>Total</b>		<b>0.0</b>	
<b>20 Skud</b> 	1:	10.0	←
	2:	10.1	↓
	3:	9.5	←
	4:	10.8x	↙
	5:	10.1	↑
	6:	10.1	↓
	7:	10.2	↗
	8:	10.4	↙
	9:	10.3	↙
	10:	10.1	↖
	<b>Serie</b>		<b>99.0</b>
<b>Total</b>		<b>99.0</b>	
<b>20 Skud</b> 	11:	10.5x	↗
	12:	10.5x	↑
	13:	10.4	←
	14:	10.2	↙
	15:	10.4	↓
	16:	10.6x	←
	17:	10.7x	↗
	18:	10.4	↖
	19:	10.8x	←
	20:	9.9	↑
	<b>Serie</b>		<b>99.0</b>
<b>Total</b>		<b>198.0</b>	



<p><b>Prøve</b></p>	<table style="width:100%; border-collapse: collapse;"> <tr><td style="width:10%;">1:</td><td style="width:70%;">9.7</td><td style="width:20%; text-align: right;">↗</td></tr> <tr><td>2:</td><td>9.5</td><td style="text-align: right;">↗</td></tr> <tr><td>3:</td><td>10.0</td><td style="text-align: right;">↗</td></tr> <tr><td>4:</td><td>9.7</td><td style="text-align: right;">↘</td></tr> <tr><td>5:</td><td>10.4</td><td style="text-align: right;">↙</td></tr> <tr><td>6:</td><td>10.7x</td><td style="text-align: right;">↘</td></tr> </table>	1:	9.7	↗	2:	9.5	↗	3:	10.0	↗	4:	9.7	↘	5:	10.4	↙	6:	10.7x	↘
1:	9.7	↗																	
2:	9.5	↗																	
3:	10.0	↗																	
4:	9.7	↘																	
5:	10.4	↙																	
6:	10.7x	↘																	
<table style="width:100%; border-collapse: collapse;"> <tr> <td style="width:10%;"><b>Serie</b></td> <td style="width:70%;"></td> <td style="width:20%; text-align: right;"><b>57.0</b></td> </tr> <tr> <td><b>Total</b></td> <td></td> <td style="text-align: right;"><b>0.0</b></td> </tr> </table>		<b>Serie</b>		<b>57.0</b>	<b>Total</b>		<b>0.0</b>												
<b>Serie</b>		<b>57.0</b>																	
<b>Total</b>		<b>0.0</b>																	

<p><b>20 Skud</b></p>	<table style="width:100%; border-collapse: collapse;"> <tr><td style="width:10%;">1:</td><td style="width:70%;">9.7</td><td style="width:20%; text-align: right;">→</td></tr> <tr><td>2:</td><td>10.6x</td><td style="text-align: right;">←</td></tr> <tr><td>3:</td><td>10.1</td><td style="text-align: right;">↘</td></tr> <tr><td>4:</td><td>10.6x</td><td style="text-align: right;">↘</td></tr> <tr><td>5:</td><td>10.2</td><td style="text-align: right;">↘</td></tr> <tr><td>6:</td><td>10.5</td><td style="text-align: right;">↘</td></tr> <tr><td>7:</td><td>9.9</td><td style="text-align: right;">↗</td></tr> <tr><td>8:</td><td>10.4</td><td style="text-align: right;">↗</td></tr> <tr><td>9:</td><td>10.0</td><td style="text-align: right;">↘</td></tr> <tr><td>10:</td><td>10.1</td><td style="text-align: right;">→</td></tr> </table>	1:	9.7	→	2:	10.6x	←	3:	10.1	↘	4:	10.6x	↘	5:	10.2	↘	6:	10.5	↘	7:	9.9	↗	8:	10.4	↗	9:	10.0	↘	10:	10.1	→
1:	9.7	→																													
2:	10.6x	←																													
3:	10.1	↘																													
4:	10.6x	↘																													
5:	10.2	↘																													
6:	10.5	↘																													
7:	9.9	↗																													
8:	10.4	↗																													
9:	10.0	↘																													
10:	10.1	→																													
<table style="width:100%; border-collapse: collapse;"> <tr> <td style="width:10%;"><b>Serie</b></td> <td style="width:70%;"></td> <td style="width:20%; text-align: right;"><b>98.0</b></td> </tr> <tr> <td><b>Total</b></td> <td></td> <td style="text-align: right;"><b>98.0</b></td> </tr> </table>		<b>Serie</b>		<b>98.0</b>	<b>Total</b>		<b>98.0</b>																								
<b>Serie</b>		<b>98.0</b>																													
<b>Total</b>		<b>98.0</b>																													

<p><b>20 Skud</b></p>	<table style="width:100%; border-collapse: collapse;"> <tr><td style="width:10%;">11:</td><td style="width:70%;">10.6x</td><td style="width:20%; text-align: right;">↗</td></tr> <tr><td>12:</td><td>10.5x</td><td style="text-align: right;">↗</td></tr> <tr><td>13:</td><td>10.1</td><td style="text-align: right;">→</td></tr> <tr><td>14:</td><td>10.4</td><td style="text-align: right;">↘</td></tr> <tr><td>15:</td><td>10.4</td><td style="text-align: right;">↘</td></tr> <tr><td>16:</td><td>10.5</td><td style="text-align: right;">↗</td></tr> <tr><td>17:</td><td>10.1</td><td style="text-align: right;">↗</td></tr> <tr><td>18:</td><td>10.0</td><td style="text-align: right;">←</td></tr> <tr><td>19:</td><td>10.0</td><td style="text-align: right;">↗</td></tr> <tr><td>20:</td><td>10.6x</td><td style="text-align: right;">↙</td></tr> </table>	11:	10.6x	↗	12:	10.5x	↗	13:	10.1	→	14:	10.4	↘	15:	10.4	↘	16:	10.5	↗	17:	10.1	↗	18:	10.0	←	19:	10.0	↗	20:	10.6x	↙
11:	10.6x	↗																													
12:	10.5x	↗																													
13:	10.1	→																													
14:	10.4	↘																													
15:	10.4	↘																													
16:	10.5	↗																													
17:	10.1	↗																													
18:	10.0	←																													
19:	10.0	↗																													
20:	10.6x	↙																													
<table style="width:100%; border-collapse: collapse;"> <tr> <td style="width:10%;"><b>Serie</b></td> <td style="width:70%;"></td> <td style="width:20%; text-align: right;"><b>100.0</b></td> </tr> <tr> <td><b>Total</b></td> <td></td> <td style="text-align: right;"><b>198.0</b></td> </tr> </table>		<b>Serie</b>		<b>100.0</b>	<b>Total</b>		<b>198.0</b>																								
<b>Serie</b>		<b>100.0</b>																													
<b>Total</b>		<b>198.0</b>																													

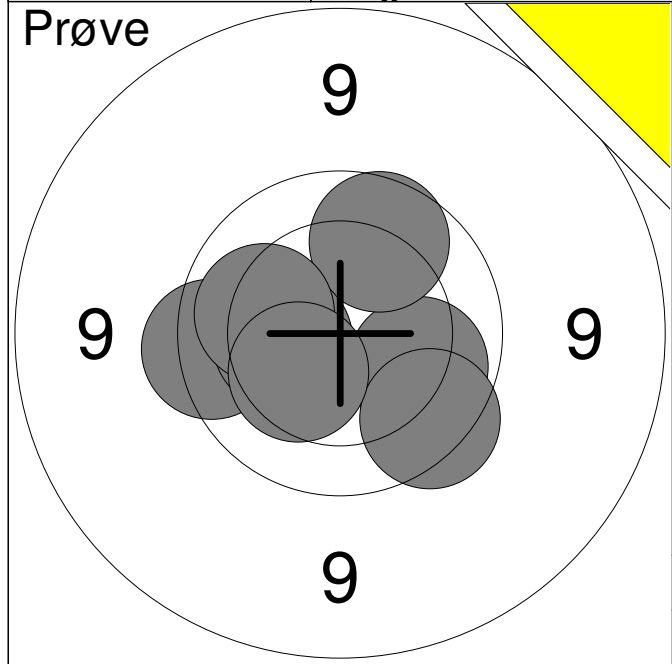

1:	10.0	↘
2:	9.7	←
3:	9.8	↘
4:	9.9	↗
5:	10.3	←
6:	10.1	←
7:	10.3	↘
<b>Serie</b>	<b>67.0</b>	
<b>Total</b>	<b>0.0</b>	

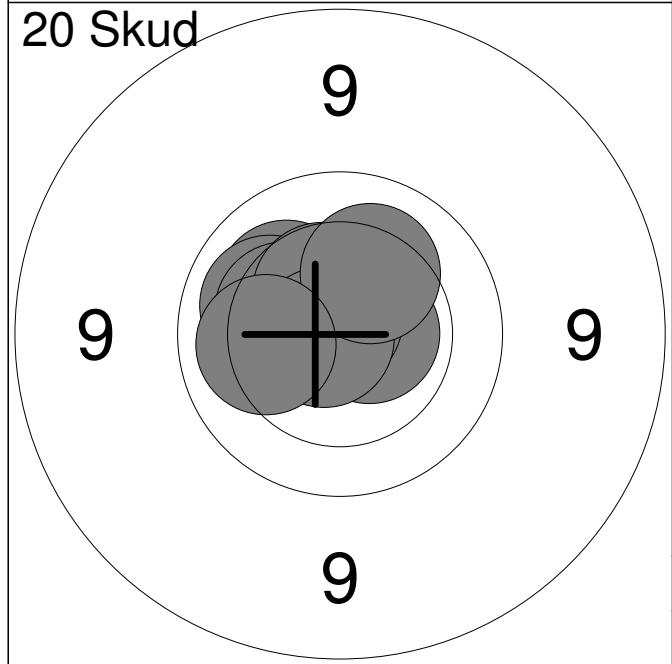

1:	10.2	↗
2:	10.6x	←
3:	10.6x	→
4:	10.1	↗
5:	10.8x	↗
6:	10.3	↗
7:	10.5	↗
8:	10.8x	←
9:	10.2	↗
10:	10.1	←
<b>Serie</b>	<b>100.0</b>	
<b>Total</b>	<b>100.0</b>	

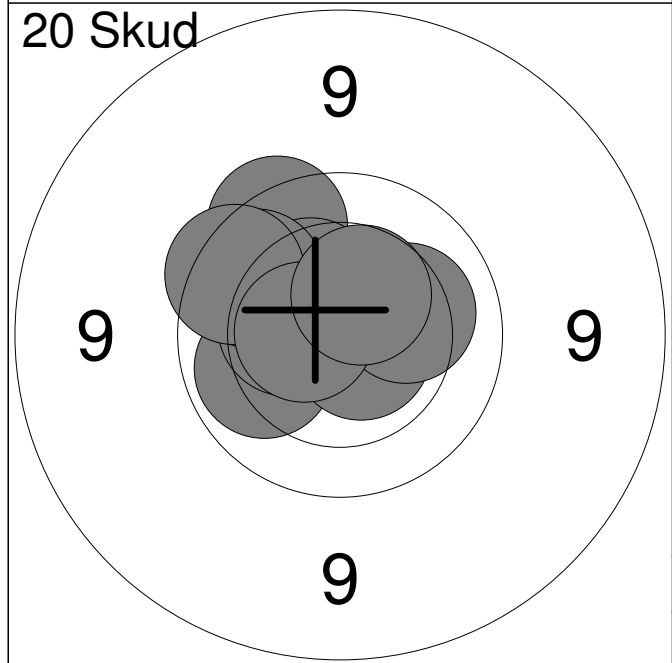

11:	10.1	←
12:	10.4	←
13:	10.7x	↘
14:	9.7	↗
15:	10.3	↗
16:	9.9	↗
17:	10.2	→
18:	9.8	↗
19:	10.6x	←
20:	10.5	↗
<b>Serie</b>	<b>97.0</b>	
<b>Total</b>	<b>197.0</b>	

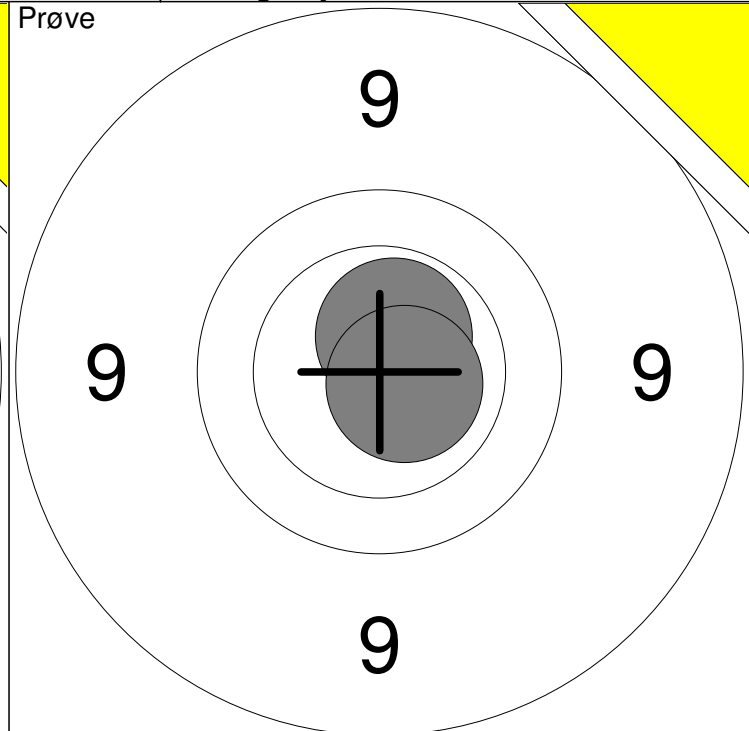
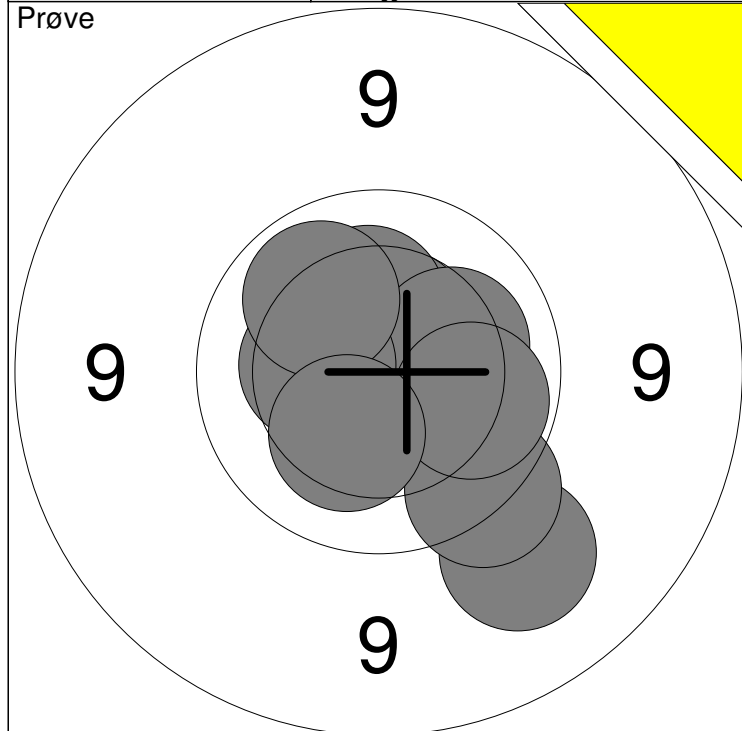

1: 9.3 ↘	6: 10.2 →	Serie	98
2: 9.7 ↘	7: 10.4 ←		
3: 10.5 ↑	8: 10.1 ↗	Total	0
4: 10.3 →	9: 10.0 →		
5: 10.3 ↑	10: 10.3 ↘		

11: 10.6x ↗	Serie	20
12: 10.7x →		
Total		0

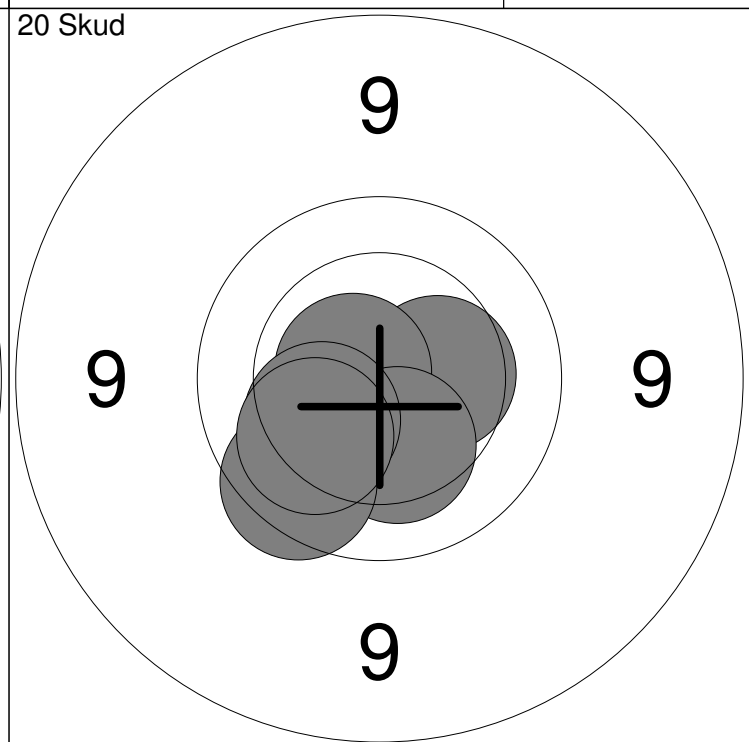
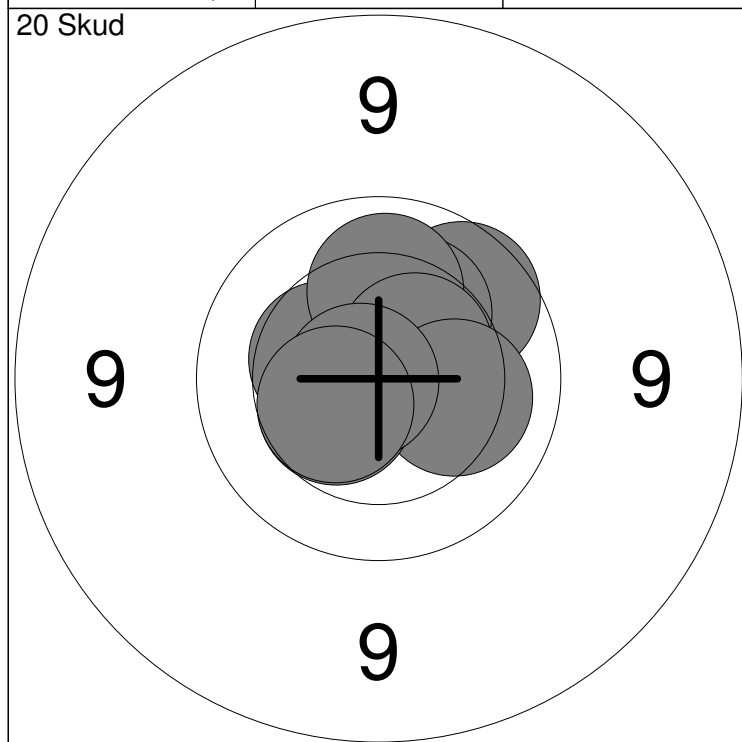

1: 9.9 ↗	6: 10.5x ↗	Serie	99
2: 10.2 ↑	7: 10.2 →		
3: 10.6x →	8: 10.5 ←	Total	99
4: 10.4 ←	9: 10.8x ←		
5: 10.1 ↑	10: 10.5 ←		

11: 10.7x ↘	16: 10.1 ↘	Serie	99
12: 10.7x ↘	17: 10.3 ↘		
13: 10.7x ↘	18: 9.8 ↘	Total	198
14: 10.4 →	19: 10.3 ←		
15: 10.7x ←	20: 10.1 ↘		

Hold <b>21</b>	Skive <b>4</b>	<b>Anna Pejs Wernich Thomsen</b>	
-------------------	-------------------	----------------------------------	--

15m	Lindholm Sports Skytte Klub	MB1
-----	-----------------------------	-----

30.01.2015	Nordjysk mesterskab 2015	Aalborg Skyttekreds
------------	--------------------------	---------------------

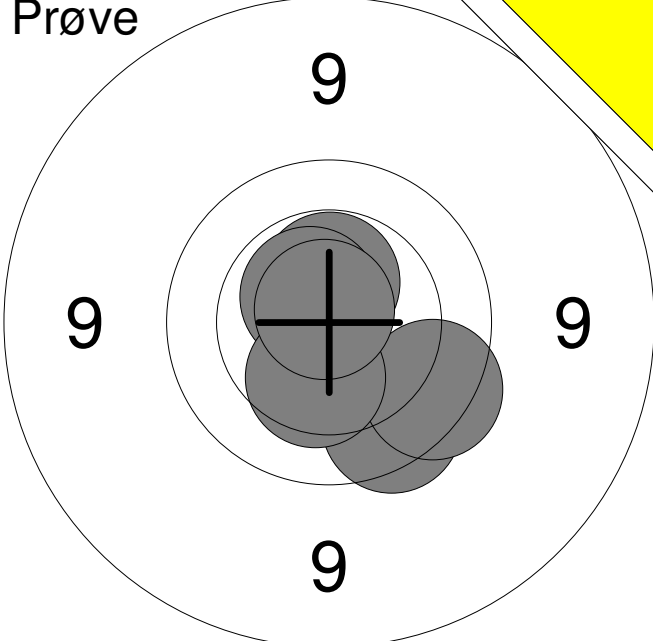
<b>Prøve</b> 	1: 9.8 ↘
	2: 9.8 ↘
	3: 10.5x ↑
	4: 10.6x ↗
	5: 10.3 ↘
	6: 10.8x ↗
	<b>Serie 58.0</b>
	<b>Total 0.0</b>

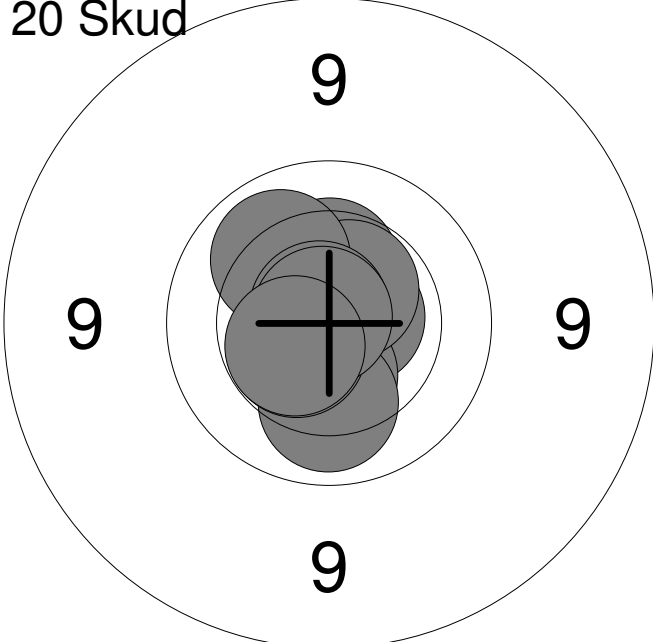
<b>20 Skud</b> 	1: 10.7x →
	2: 10.4 ↓
	3: 10.1 ↓
	4: 10.5x ↙
	5: 10.3 ↑
	6: 10.5x ↗
	7: 10.1 ↗
	8: 10.8x ↗
	9: 10.9x ↗
	10: 10.5x ↙
	<b>Serie 100.0</b>
	<b>Total 100.0</b>

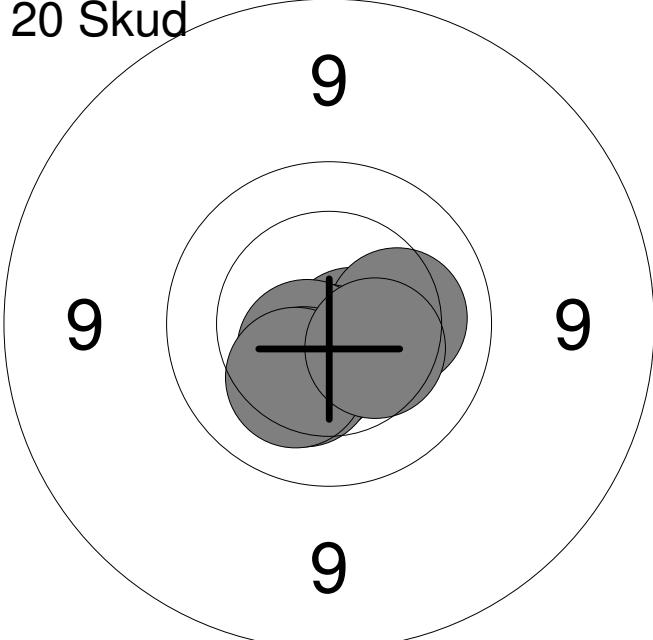
<b>20 Skud</b> 	11: 10.6x ↘
	12: 10.6x ↘
	13: 10.7x ↘
	14: 10.2 →
	15: 10.6x ↓
	16: 10.5x ↓
	17: 10.6x ↙
	18: 10.3 ↙
	19: 10.3 ↙
	20: 10.4 ↘
	<b>Serie 100.0</b>
	<b>Total 200.0</b>

Hold	Skive	Christian P. W. Thomsen	
21	5	Lindholm Sports Skytte Klub	MB2
15m			
30.01.2015	Nordjysk mesterskab 2015	Aalborg Skyttekreds	
Prøve		1: 10.0	↘
		2: 10.5	↘
		3: 10.7x	→
		4: 10.5	↘
		5: 10.4	↘
		<b>Serie</b>	<b>50.0</b>
		<b>Total</b>	<b>0.0</b>
20 Skud		1: 10.6x	↘
		2: 10.8x	↗
		3: 10.6x	→
		4: 10.0	↘
		5: 10.1	→
		6: 10.3	↘
		7: 10.1	→
		8: 10.3	↘
		9: 10.0	↘
		10: 9.9	↘
		<b>Serie</b>	<b>99.0</b>
		<b>Total</b>	<b>99.0</b>
20 Skud		11: 9.9	↖
		12: 10.4	↖
		13: 10.4	↖
		14: 10.9x	↗
		15: 10.9x	↗
		16: 10.1	↗
		17: 10.8x	↗
		18: 10.8x	↘
		19: 10.6x	→
		20: 10.7x	↘
		<b>Serie</b>	<b>99.0</b>
		<b>Total</b>	<b>198.0</b>

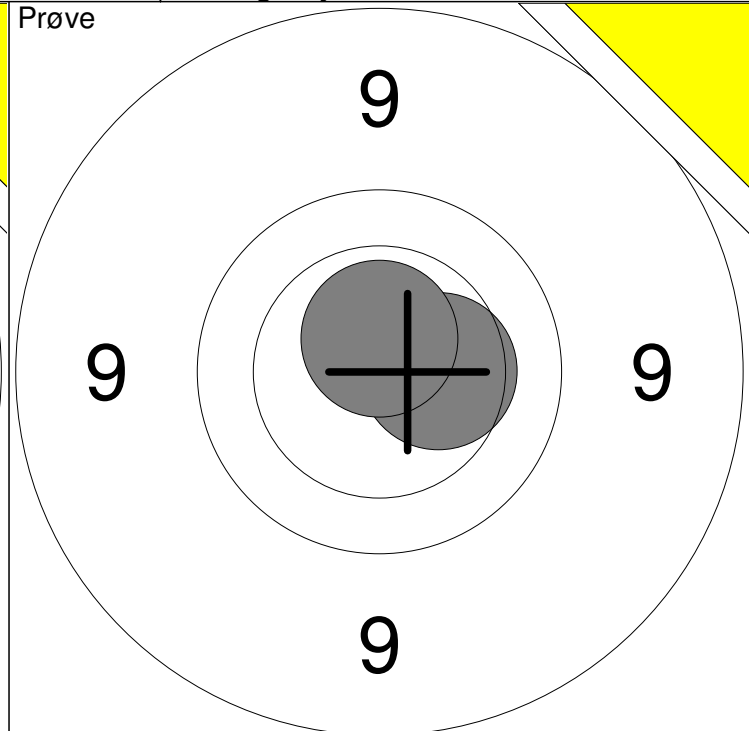
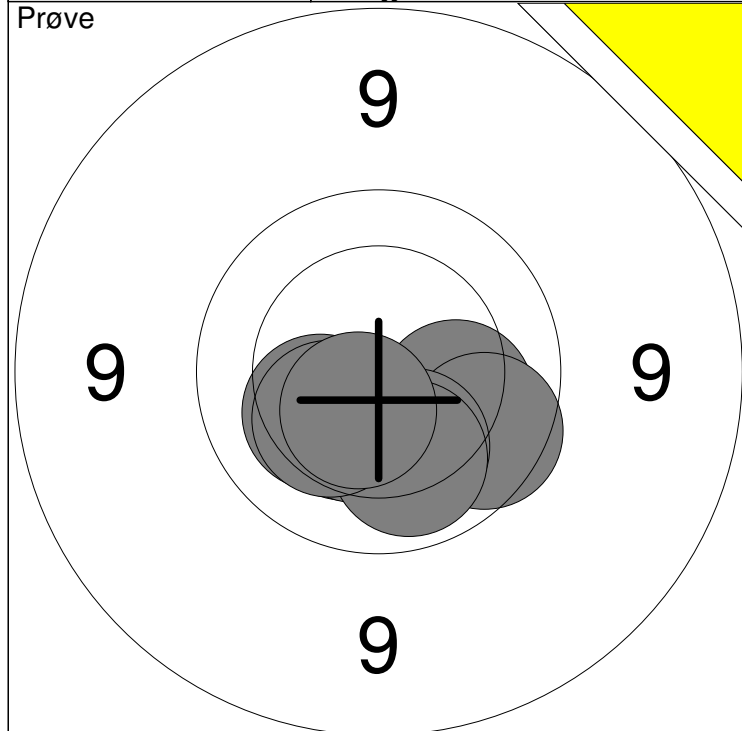

1: 10.2 →	7: 10.4 ↓	Serie	89
2: 9.9 →	8: 10.1 ↓		
3: 10.4 ↓	9: 10.3 ↓	Total	0
4: 10.2 ↓	10: 10.5x ↓		
5: 10.3 ↙			

11: 10.4 →	Serie	20
12: 10.6x ↑		
	Total	0

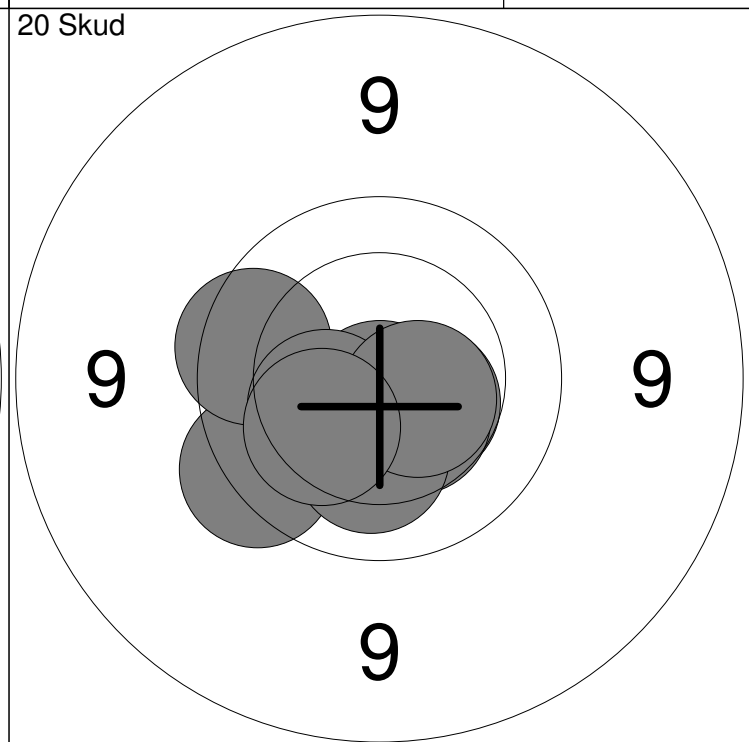
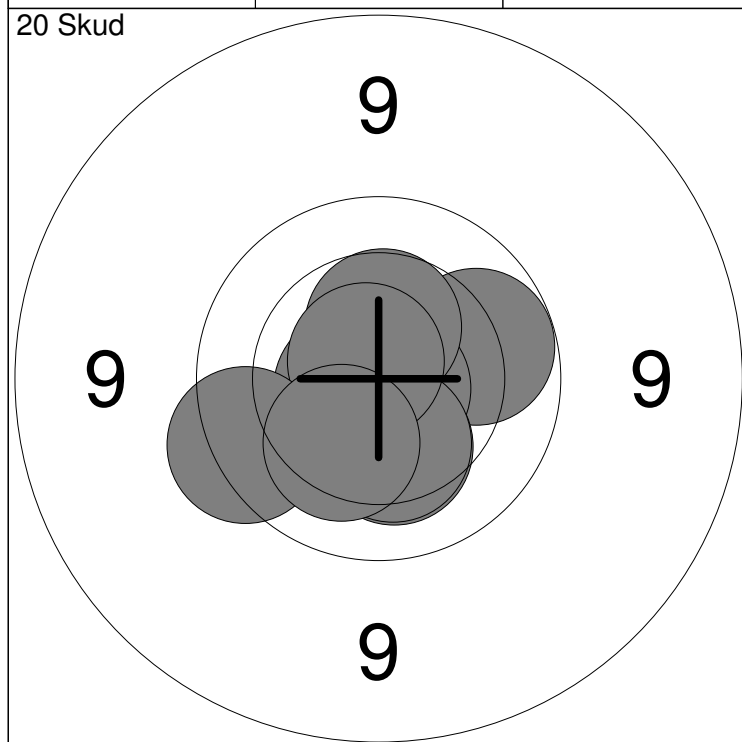

1: 10.5x ↙	6: 10.3 ↓	Serie	99
2: 10.0 →	7: 10.5 ↑		
3: 10.7x ↙	8: 10.7x ↗	Total	99
4: 10.3 ↓	9: 9.7 ↙		
5: 10.8x ↘	10: 10.2 ↓		

11: 10.5 →	16: 10.8x ↓	Serie	98
12: 10.5 ↓	17: 10.4 ↙		
13: 9.7 ↙	18: 10.2 ↓	Total	197
14: 10.7x ↓	19: 10.5x →		
15: 9.8 ↙	20: 10.2 ↙		

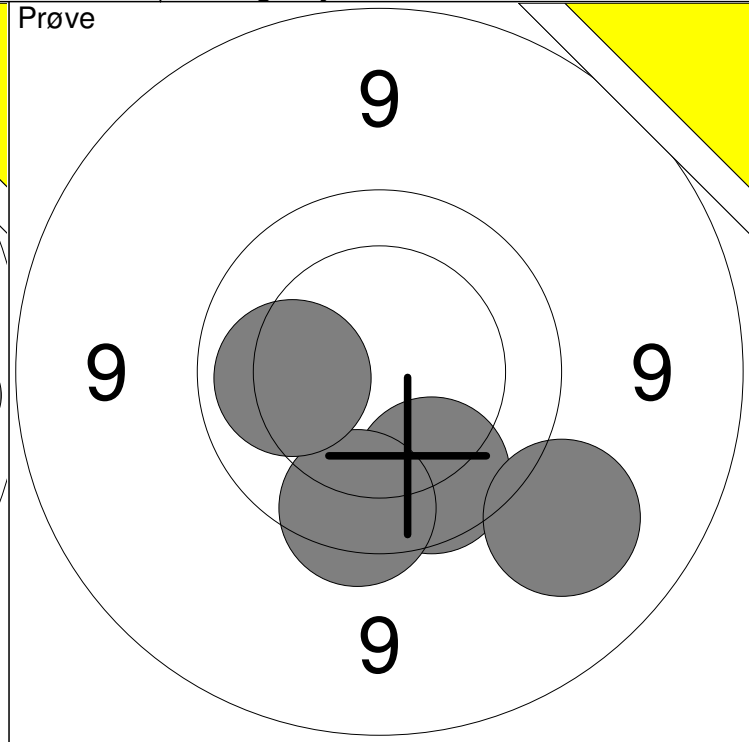
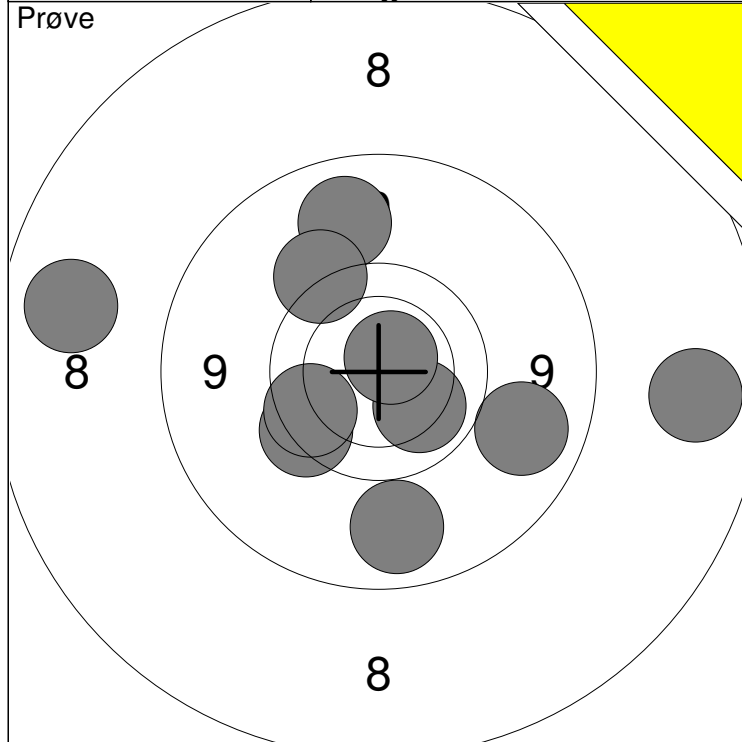

1: 9.1	↑	6: 10.1	↘	Serie	90
2: 9.5	↗	7: 10.6x	↗		
3: 9.7	↙	8: 8.1	→	Total	0
4: 9.8	↙	9: 9.1	↘		
5: 9.1	↓	10: 8.1	←		

11: 9.9	↘	Serie	37
12: 9.8	↘		
13: 9.2	↘	Total	0
14: 10.1	←		

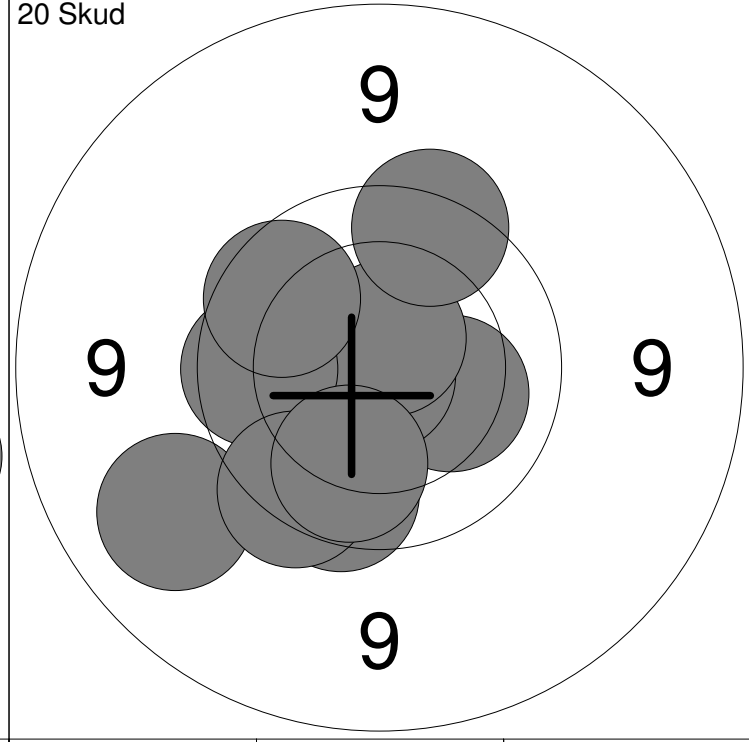
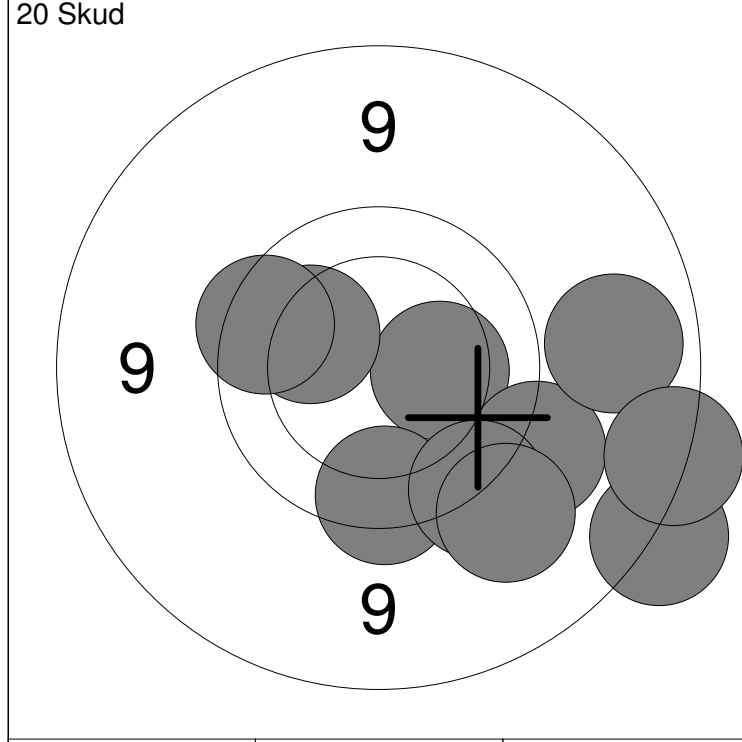

1: 10.3	→	6: 9.5	↘	Serie	90
2: 10.1	↗	7: 9.3	↘		
3: 9.4	↘	8: 9.8	↗	Total	90
4: 9.1	→	9: 8.6	↘		
5: 9.7	↓	10: 8.7	↘		

11: 10.2	→	16: 9.9	←	Serie	94
12: 10.9x	↘	17: 9.1	↙		
13: 10.7x	↗	18: 9.9	↙	Total	184
14: 9.8	↘	19: 9.7	↘		
15: 9.7	↗	20: 10.0	↘		

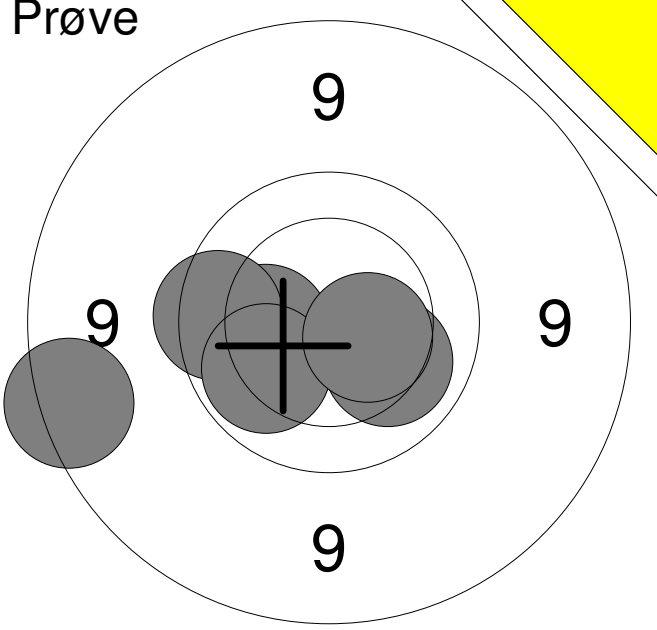
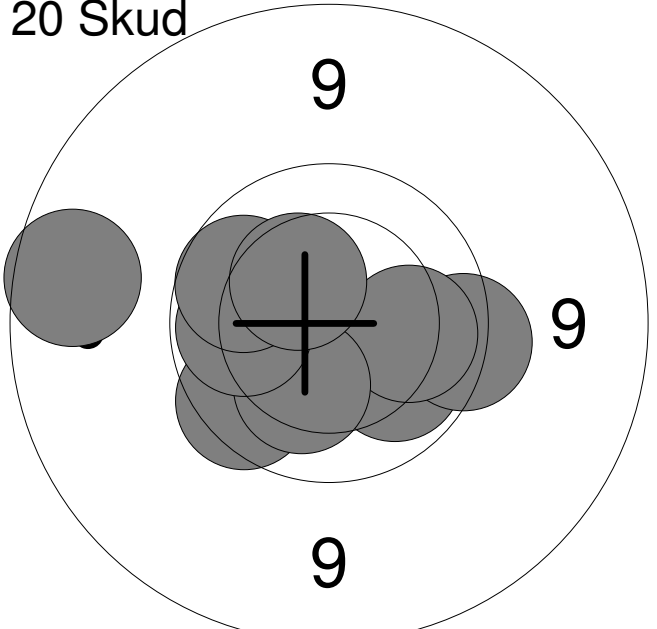
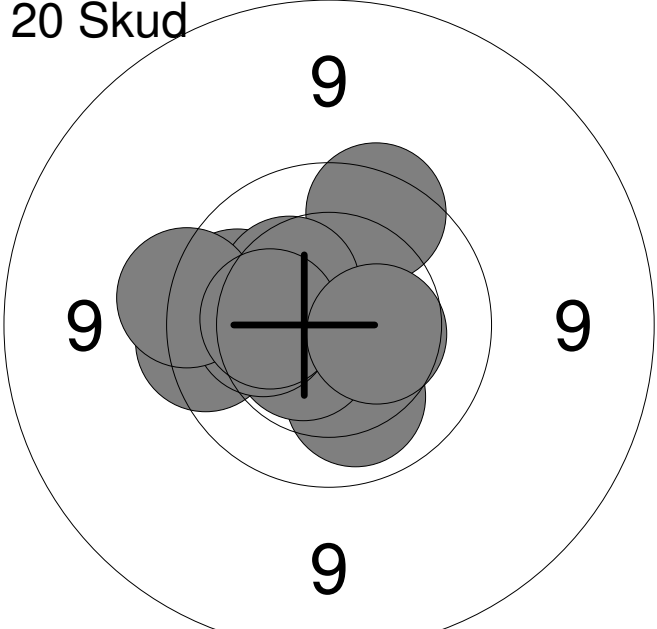
Hold	Skive	Pernille Nielsen	
21	10	Vilsted Skf.	MJ2
15m			
30.01.2015	Nordjysk mesterskab 2015	Aalborg Skyttekreds	
<b>Prøve</b> 	1:	8.8	←
	2:	10.2	←
	3:	9.8	←
	4:	10.1	↘
	5:	10.0	←
	6:	10.5	↘
	<b>Serie</b>	<b>57.0</b>	
	<b>Total</b>	<b>0.0</b>	
<b>20 Skud</b> 	1:	9.8	↙
	2:	10.0	↘
	3:	9.7	→
	4:	10.7x	←
	5:	10.1	→
	6:	10.2	↘
	7:	8.9	←
	8:	10.0	←
	9:	9.9	↗
	10:	10.4	↗
	<b>Serie</b>	<b>95.0</b>	
	<b>Total</b>	<b>95.0</b>	
<b>20 Skud</b> 	11:	9.9	←
	12:	9.8	←
	13:	9.8	↗
	14:	10.1	↘
	15:	10.6x	←
	16:	10.2	←
	17:	10.4	↗
	18:	9.6	←
	19:	10.3	←
	20:	10.4	→
	<b>Serie</b>	<b>96.0</b>	
	<b>Total</b>	<b>191.0</b>	

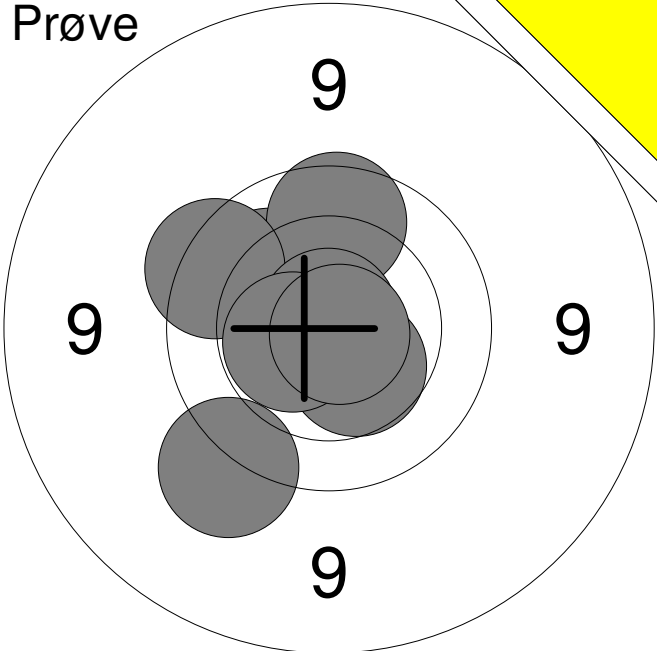
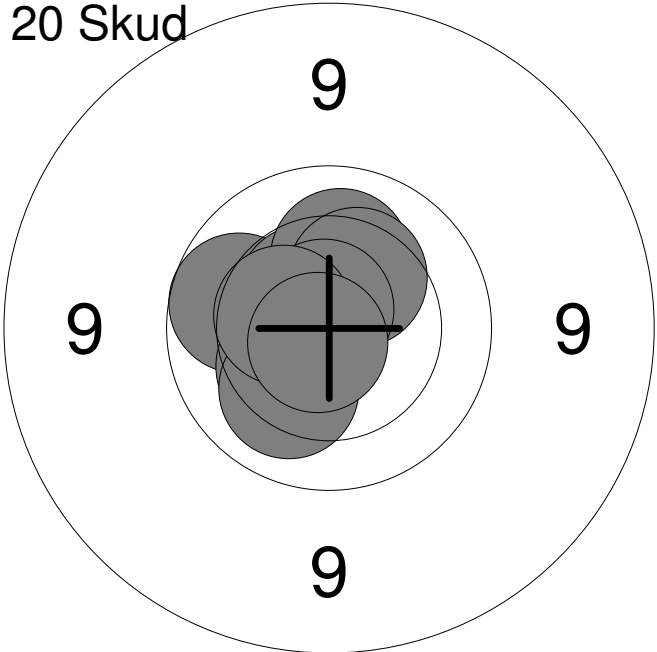
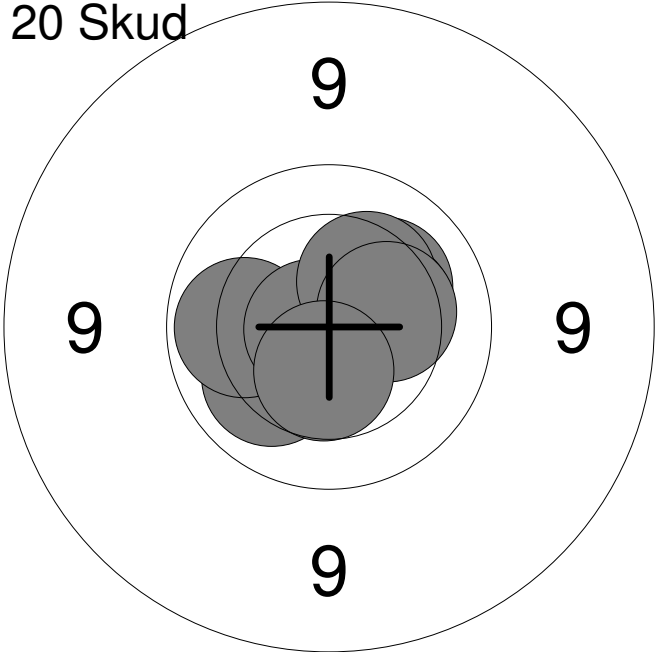

Hold	Skive	Niklas Pedersen	
21	12		
15m	Aalborg Skyttekreds	BK2	
30.01.2015	Nordjysk mesterskab 2015	Aalborg Skyttekreds	
Prøve		1: 9.5 ↙	
		2: 10.1 ↗	
		3: 9.9 ↑	
		4: 9.7 ↖	
		5: 10.8x ↑	
		6: 10.4 ↘	
		7: 10.5x ←	
		8: 10.8x ↘	
	Serie	77.0	
	Total	0.0	
20 Skud		1: 10.7x ↑	
		2: 9.9 ←	
		3: 10.5x ↗	
		4: 10.2 ↑	
		5: 10.3 ↗	
		6: 10.7x ↑	
		7: 10.3 ↘	
		8: 10.2 ↘	
		9: 10.4 ←	
		10: 10.8x ↘	
	Serie	99.0	
	Total	99.0	
20 Skud		11: 10.3 ↗	
		12: 10.2 ↗	
		13: 10.3 ↖	
		14: 10.1 ↖	
		15: 10.3 ↗	
		16: 10.0 ←	
		17: 10.8x ←	
		18: 10.3 ↗	
		19: 10.3 →	
		20: 10.5 ↓	
	Serie	100.0	
	Total	199.0	

Hold <b>22</b>	Skive <b>3</b>	<b>Simon Key Hald</b>	
-------------------	-------------------	-----------------------	--

15m	Vilsted Skf.	MB1
-----	--------------	-----

30.01.2015	Nordjysk mesterskab 2015	Aalborg Skyttekreds
------------	--------------------------	---------------------

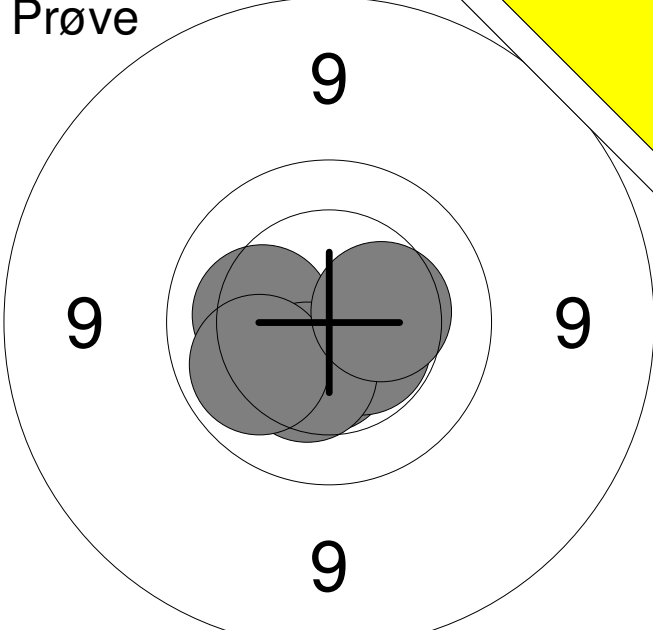
<b>Prøve</b> 	1: 10.2	↙	
	2: 10.6x	↘	
	3: 10.5x	↓	
	4: 10.5x	↘	
	5: 10.2	↙	
	6: 10.4	↓	
	7: 10.1	↙	
	8: 10.4	→	
	<b>Serie</b>	<b>80.0</b>	
	<b>Total</b>	<b>0.0</b>	

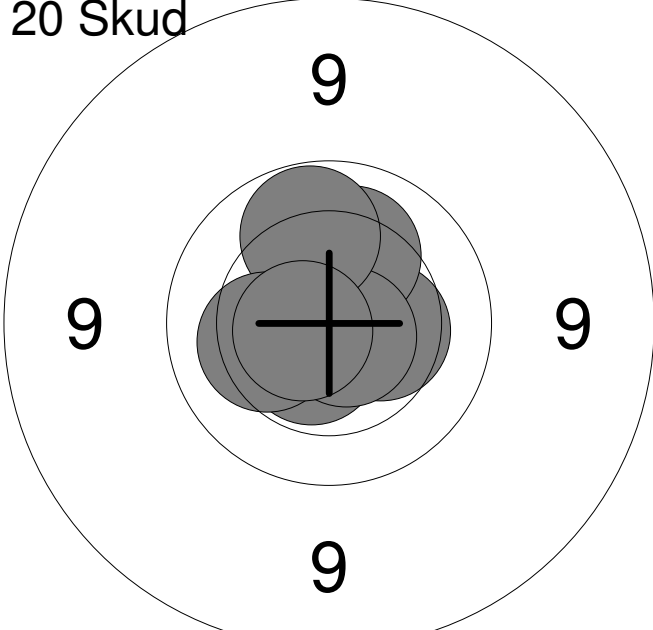
<b>20 Skud</b> 	1: 10.7x	↙
	2: 10.6x	→
	3: 10.4	→
	4: 10.2	↑
	5: 10.9x	↙
	6: 10.6x	↓
	7: 10.7x	↘
	8: 10.0	↑
	9: 10.2	↙
	10: 10.7x	↙
	<b>Serie</b>	<b>100.0</b>
<b>Total</b>	<b>100.0</b>	

<b>20 Skud</b> 	11: 10.7x	→
	12: 10.1	↙
	13: 10.0	↓
	14: 10.6x	↗
	15: 10.0	↙
	16: 10.6x	↗
	17: 10.9x	↗
	18: 10.5x	↓
	19: 10.2	↑
	20: 10.5	↙
	<b>Serie</b>	<b>100.0</b>
<b>Total</b>	<b>200.0</b>	

<p><b>Prøve</b></p>	<table style="width:100%; border-collapse: collapse;"> <tr><td style="width:10%;">1:</td><td style="width:80%;">9.8</td><td style="width:10%; text-align: right;">→</td></tr> <tr><td>2:</td><td>10.0</td><td style="text-align: right;">↙</td></tr> <tr><td>3:</td><td>10.1</td><td style="text-align: right;">↘</td></tr> <tr><td>4:</td><td>10.0</td><td style="text-align: right;">↓</td></tr> <tr><td>5:</td><td>10.7x</td><td style="text-align: right;">→</td></tr> <tr><td>6:</td><td>10.7x</td><td style="text-align: right;">↓</td></tr> </table>	1:	9.8	→	2:	10.0	↙	3:	10.1	↘	4:	10.0	↓	5:	10.7x	→	6:	10.7x	↓
1:	9.8	→																	
2:	10.0	↙																	
3:	10.1	↘																	
4:	10.0	↓																	
5:	10.7x	→																	
6:	10.7x	↓																	
<table style="width:100%; border-collapse: collapse;"> <tr> <td style="width:80%;"><b>Serie</b></td> <td style="text-align: right;"><b>59.0</b></td> </tr> <tr> <td><b>Total</b></td> <td style="text-align: right;"><b>0.0</b></td> </tr> </table>		<b>Serie</b>	<b>59.0</b>	<b>Total</b>	<b>0.0</b>														
<b>Serie</b>	<b>59.0</b>																		
<b>Total</b>	<b>0.0</b>																		

<p><b>20 Skud</b></p>	<table style="width:100%; border-collapse: collapse;"> <tr><td style="width:10%;">1:</td><td style="width:80%;">10.8x</td><td style="width:10%; text-align: right;">↗</td></tr> <tr><td>2:</td><td>10.8x</td><td style="text-align: right;">↑</td></tr> <tr><td>3:</td><td>10.7x</td><td style="text-align: right;">→</td></tr> <tr><td>4:</td><td>10.6x</td><td style="text-align: right;">↙</td></tr> <tr><td>5:</td><td>10.1</td><td style="text-align: right;">↗</td></tr> <tr><td>6:</td><td>10.5x</td><td style="text-align: right;">↗</td></tr> <tr><td>7:</td><td>10.3</td><td style="text-align: right;">↘</td></tr> <tr><td>8:</td><td>10.4</td><td style="text-align: right;">↘</td></tr> <tr><td>9:</td><td>10.0</td><td style="text-align: right;">→</td></tr> <tr><td>10:</td><td>10.2</td><td style="text-align: right;">↓</td></tr> </table>	1:	10.8x	↗	2:	10.8x	↑	3:	10.7x	→	4:	10.6x	↙	5:	10.1	↗	6:	10.5x	↗	7:	10.3	↘	8:	10.4	↘	9:	10.0	→	10:	10.2	↓
1:	10.8x	↗																													
2:	10.8x	↑																													
3:	10.7x	→																													
4:	10.6x	↙																													
5:	10.1	↗																													
6:	10.5x	↗																													
7:	10.3	↘																													
8:	10.4	↘																													
9:	10.0	→																													
10:	10.2	↓																													
<table style="width:100%; border-collapse: collapse;"> <tr> <td style="width:80%;"><b>Serie</b></td> <td style="text-align: right;"><b>100.0</b></td> </tr> <tr> <td><b>Total</b></td> <td style="text-align: right;"><b>100.0</b></td> </tr> </table>		<b>Serie</b>	<b>100.0</b>	<b>Total</b>	<b>100.0</b>																										
<b>Serie</b>	<b>100.0</b>																														
<b>Total</b>	<b>100.0</b>																														

<p><b>20 Skud</b></p>	<table style="width:100%; border-collapse: collapse;"> <tr><td style="width:10%;">11:</td><td style="width:80%;">10.7x</td><td style="width:10%; text-align: right;">→</td></tr> <tr><td>12:</td><td>10.5</td><td style="text-align: right;">↘</td></tr> <tr><td>13:</td><td>10.3</td><td style="text-align: right;">→</td></tr> <tr><td>14:</td><td>10.4</td><td style="text-align: right;">↗</td></tr> <tr><td>15:</td><td>10.7x</td><td style="text-align: right;">↗</td></tr> <tr><td>16:</td><td>10.2</td><td style="text-align: right;">↙</td></tr> <tr><td>17:</td><td>10.6x</td><td style="text-align: right;">→</td></tr> <tr><td>18:</td><td>10.5x</td><td style="text-align: right;">↙</td></tr> <tr><td>19:</td><td>10.4</td><td style="text-align: right;">↗</td></tr> <tr><td>20:</td><td>10.8x</td><td style="text-align: right;">↓</td></tr> </table>	11:	10.7x	→	12:	10.5	↘	13:	10.3	→	14:	10.4	↗	15:	10.7x	↗	16:	10.2	↙	17:	10.6x	→	18:	10.5x	↙	19:	10.4	↗	20:	10.8x	↓
11:	10.7x	→																													
12:	10.5	↘																													
13:	10.3	→																													
14:	10.4	↗																													
15:	10.7x	↗																													
16:	10.2	↙																													
17:	10.6x	→																													
18:	10.5x	↙																													
19:	10.4	↗																													
20:	10.8x	↓																													
<table style="width:100%; border-collapse: collapse;"> <tr> <td style="width:80%;"><b>Serie</b></td> <td style="text-align: right;"><b>100.0</b></td> </tr> <tr> <td><b>Total</b></td> <td style="text-align: right;"><b>200.0</b></td> </tr> </table>		<b>Serie</b>	<b>100.0</b>	<b>Total</b>	<b>200.0</b>																										
<b>Serie</b>	<b>100.0</b>																														
<b>Total</b>	<b>200.0</b>																														

Hold <b>22</b>	Skive <b>7</b>	<b>Marie Katrine Sørensen</b>	
-------------------	-------------------	-------------------------------	--

15m	Ulsted Skf.	MB3
-----	-------------	-----

30.01.2015	Nordjysk mesterskab 2015	Aalborg Skyttekreds
------------	--------------------------	---------------------

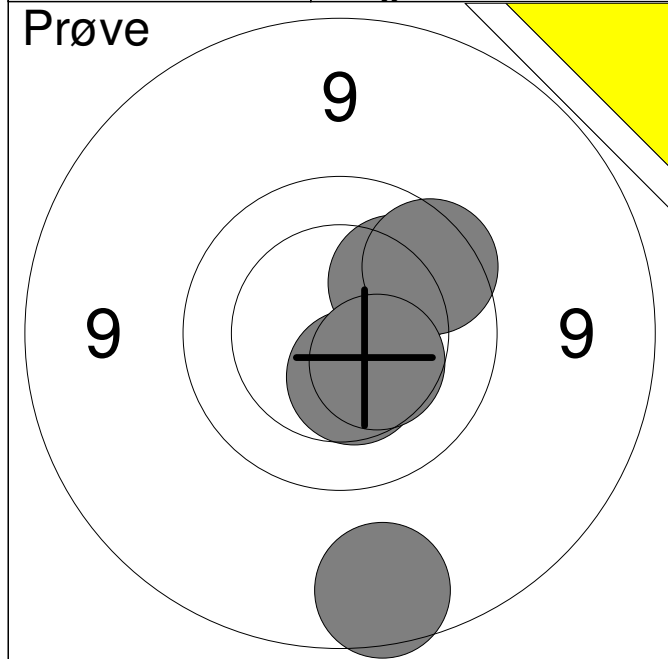

1:	8.9	↓
2:	10.1	↗
3:	10.4	↓
4:	9.8	↗
5:	10.4	↘
<b>Serie</b>	<b>47.0</b>	
<b>Total</b>	<b>0.0</b>	

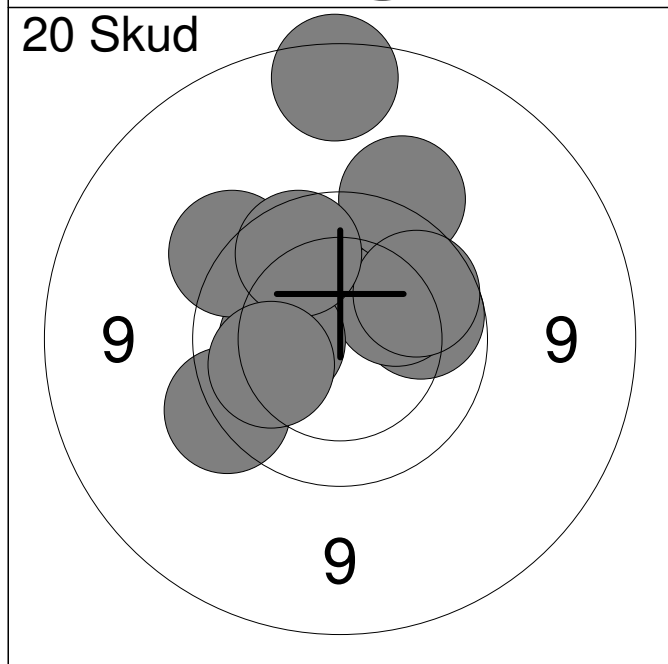

1:	9.9	→
2:	10.2	↗
3:	9.5	↑
4:	10.3	←
5:	9.6	↙
6:	9.9	↗
7:	9.6	↗
8:	8.8	↑
9:	9.9	↑
10:	10.1	←
<b>Serie</b>	<b>92.0</b>	
<b>Total</b>	<b>92.0</b>	

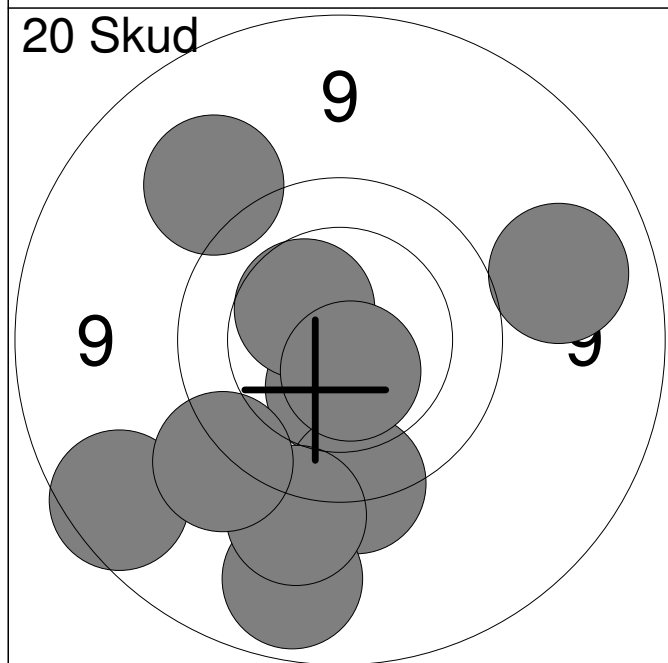

11:	9.1	→
12:	8.9	↙
13:	10.4	↓
14:	9.6	↓
15:	10.4	↗
16:	9.3	↗
17:	9.0	↓
18:	9.4	↓
19:	10.6x	↓
20:	9.5	↙
<b>Serie</b>	<b>92.0</b>	
<b>Total</b>	<b>184.0</b>	

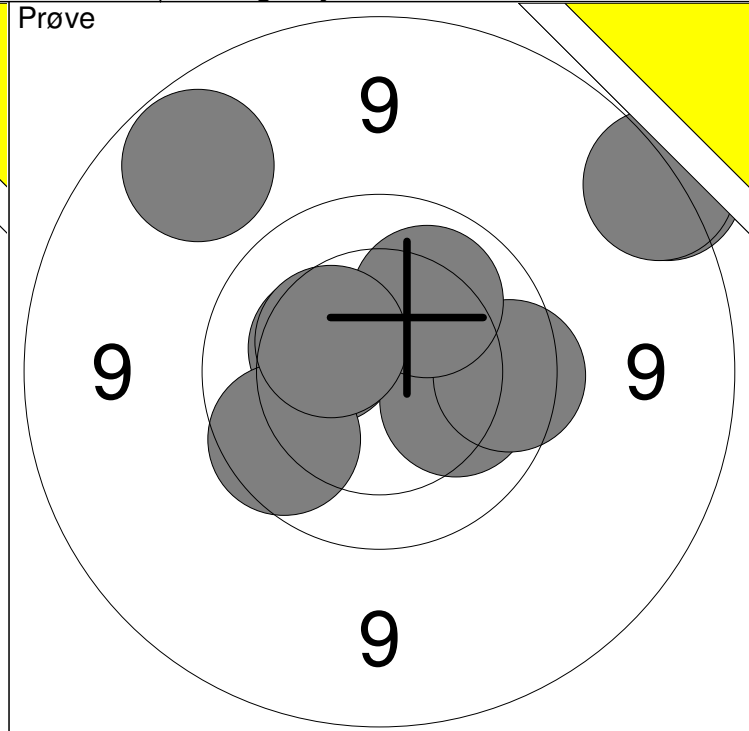
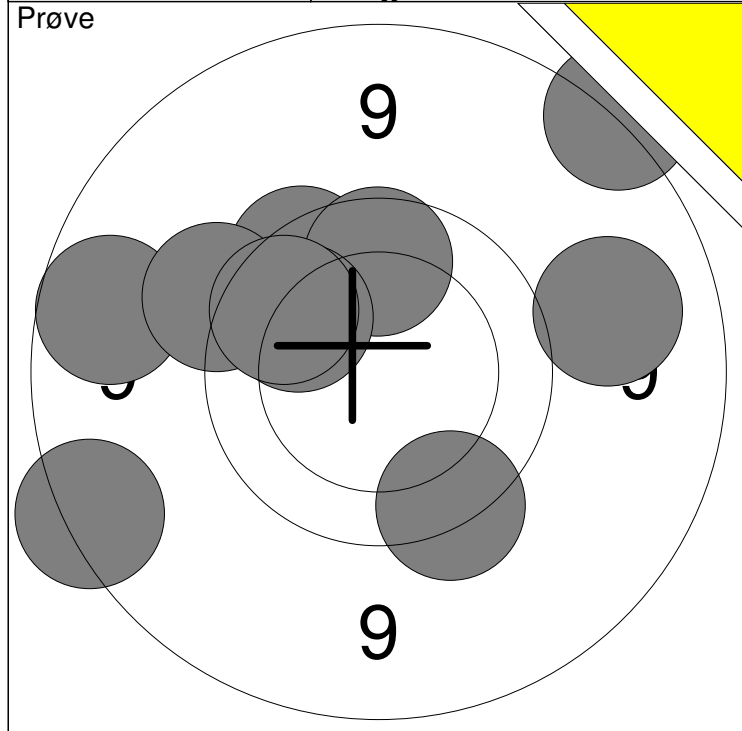

1: 9.6 ↘	6: 10.0 ↗	Serie	88
2: 8.9 ←	7: 9.5 ↖		
3: 9.7 ↗	8: 9.9 ↗	Total	0
4: 9.9 ↑	9: 9.2 →		
5: 8.7 ↗	10: 8.8 ↖		

11: 8.7 ↗	16: 9.0 ↖	Serie	83
12: 10.4 ↖	17: 10.1 ↗		
13: 9.9 ↙	18: 8.7 ↗	Total	0
14: 10.1 →	19: 10.4 ↖		
15: 9.8 →			

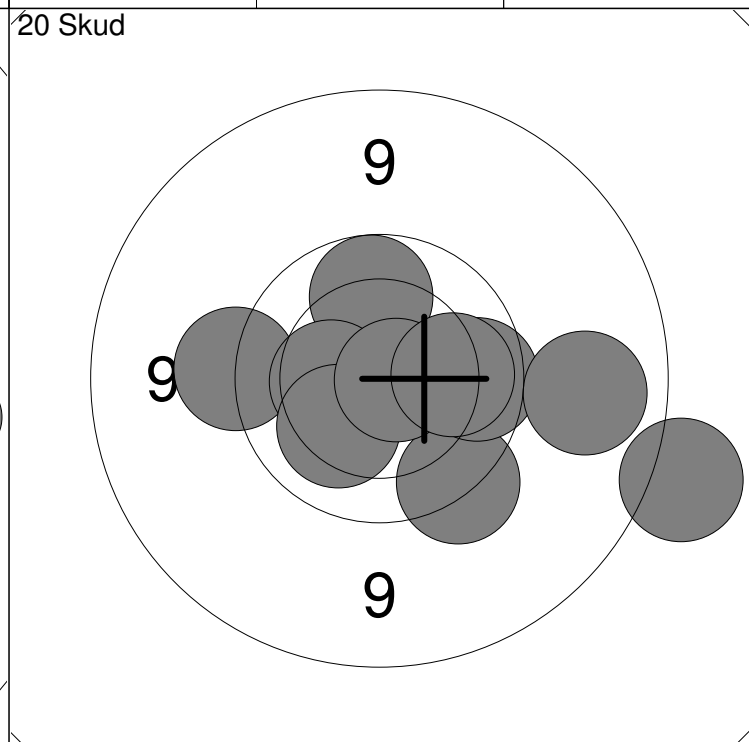
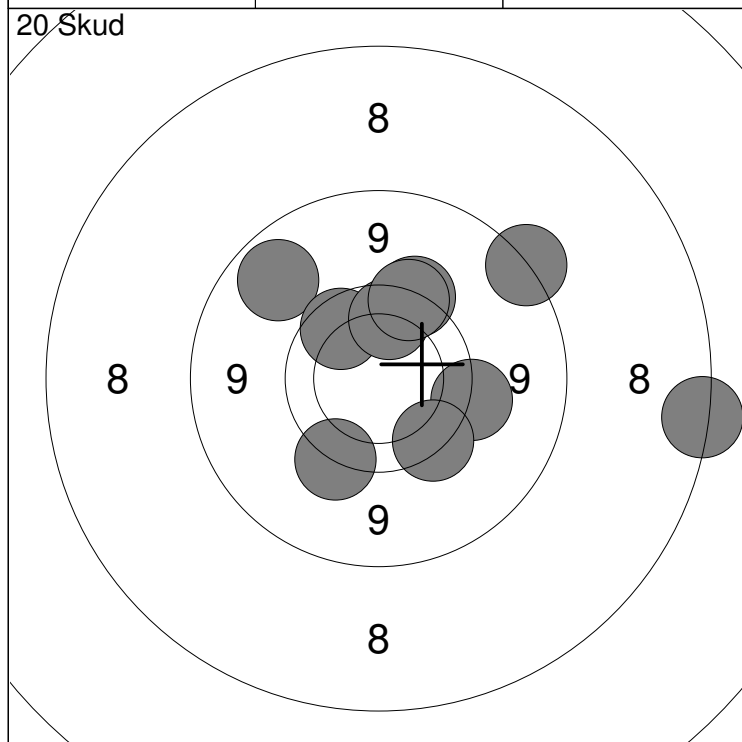

1: 9.5 ↙	6: 8.7 ↗	Serie	87
2: 9.6 ↗	7: 9.9 ↗		
3: 9.0 ↗	8: 9.6 ↘	Total	87
4: 9.5 →	9: 9.9 ↑		
5: 7.7 →	10: 9.6 ↗		

11: 9.9 ↑	16: 10.4 ←	Serie	93
12: 9.6 ↘	17: 10.2 ↙		
13: 9.8 →	18: 9.1 →	Total	180
14: 8.5 →	19: 10.7x →		
15: 9.5 ←	20: 10.1 →		

Hold <b>22</b>	Skive <b>9</b>	<b>Niclas Pedersen</b>	
-------------------	-------------------	------------------------	--

15m	Vilsted Skf.	MJ2
-----	--------------	-----

30.01.2015	Nordjysk mesterskab 2015	Aalborg Skyttekreds
------------	--------------------------	---------------------

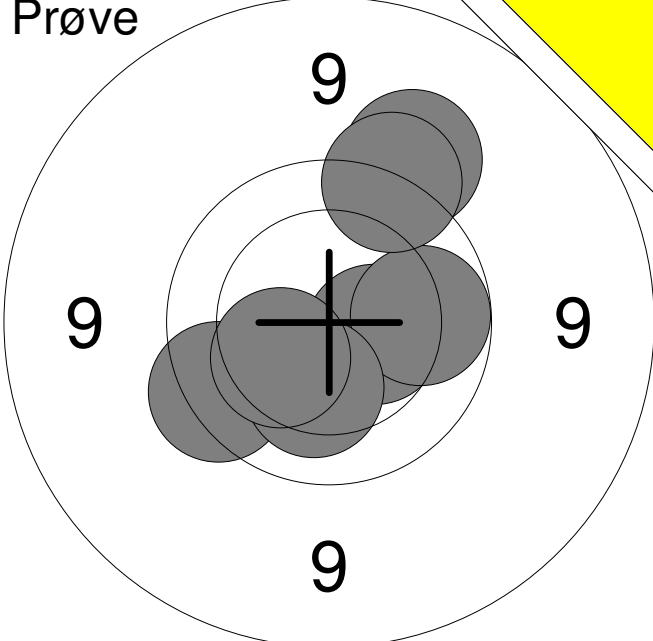
<b>Prøve</b> 	1: 10.4 →
	2: 10.0 →
	3: 9.4 ↗
	4: 9.6 ↗
	5: 9.7 ↖
	6: 10.2 ↓
	7: 10.3 ↖
<b>Serie</b>	<b>67.0</b>
<b>Total</b>	<b>0.0</b>

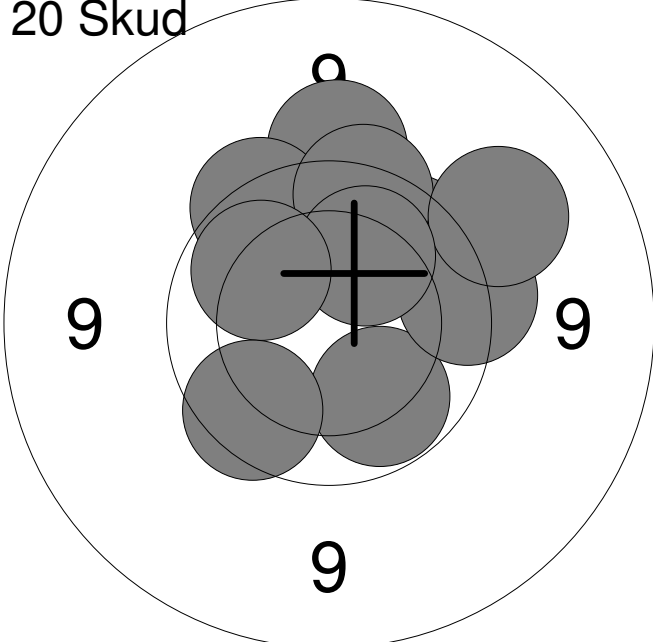
<b>20 Skud</b> 	1: 9.5 ↑
	2: 9.7 ↖
	3: 9.8 ↗
	4: 9.7 ↑
	5: 10.0 ↓
	6: 9.7 →
	7: 9.3 ↗
	8: 10.1 ↗
	9: 10.0 ↖
	10: 9.8 ↘
<b>Serie</b>	<b>93.0</b>
<b>Total</b>	<b>93.0</b>

<b>20 Skud</b> 	11: 9.1 ↖
	12: 9.7 ↖
	13: 10.2 ↗
	14: 9.9 ↑
	15: 9.9 ↗
	16: 10.1 ↓
	17: 10.7x →
	18: 9.0 ↘
	19: 10.4 ↗
	20: 9.5 ↗
<b>Serie</b>	<b>94.0</b>
<b>Total</b>	<b>187.0</b>

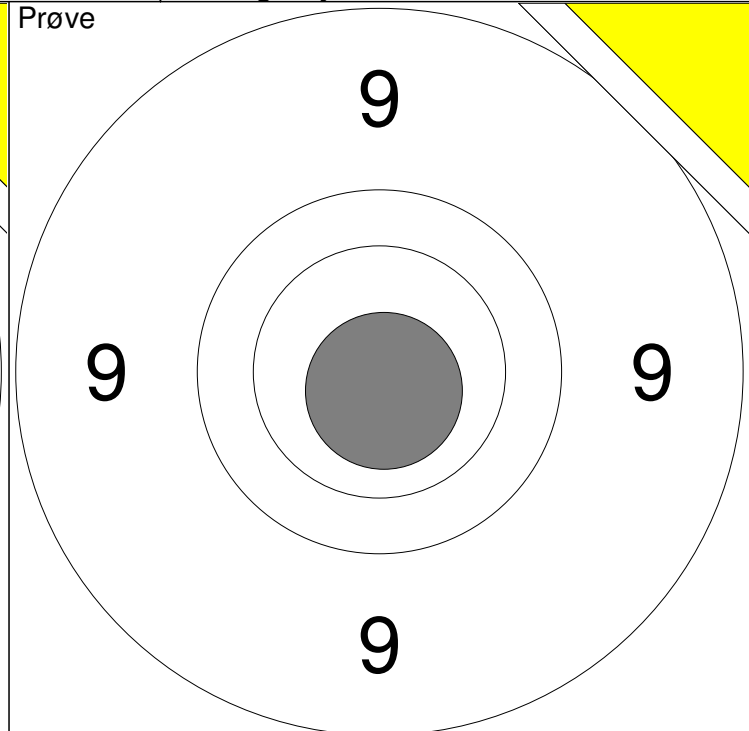
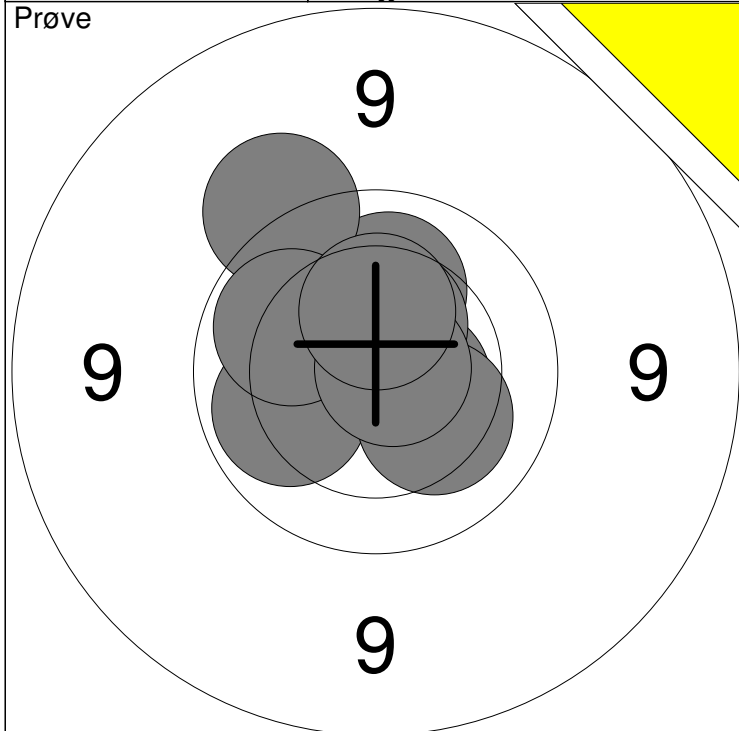

1: 10.3 ↑	6: 10.1 ←	Serie	99
2: 10.2 ↑	7: 10.0 ↖		
3: 10.6x →	8: 10.2 ↘	Total	0
4: 10.5 ↑	9: 10.8x →		
5: 9.5 ↖	10: 10.4 ↑		

11: 10.8x ↓		Serie	10
		Total	0

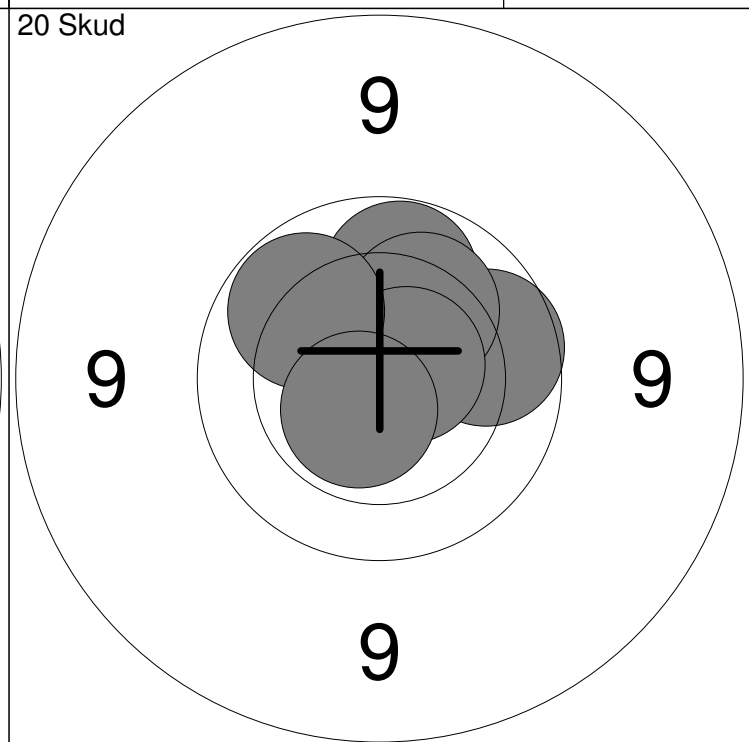
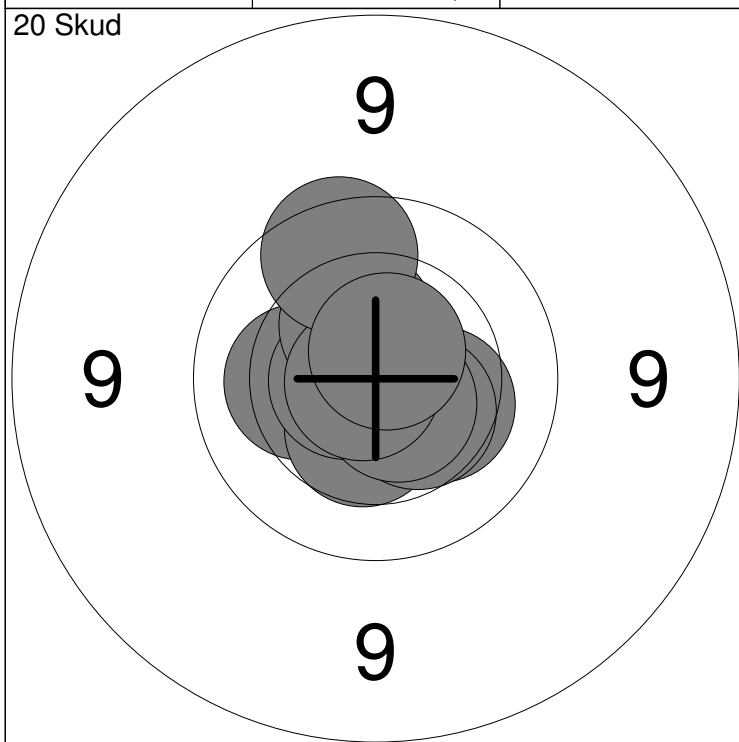

1: 10.2 ←	6: 10.4 ↑	Serie	99
2: 10.3 →	7: 10.6x ↘		
3: 10.5 ↓	8: 10.8x ←	Total	99
4: 10.7x ←	9: 9.8 ↑		
5: 10.4 ↘	10: 10.7x ↗		

11: 10.9x ↗	16: 10.8x ↖	Serie	99
12: 10.3 ↖	17: 10.2 ↗		
13: 10.0 ↑	18: 10.7x →	Total	198
14: 9.9 →	19: 10.0 ↖		
15: 10.7x ↖	20: 10.6x ↘		

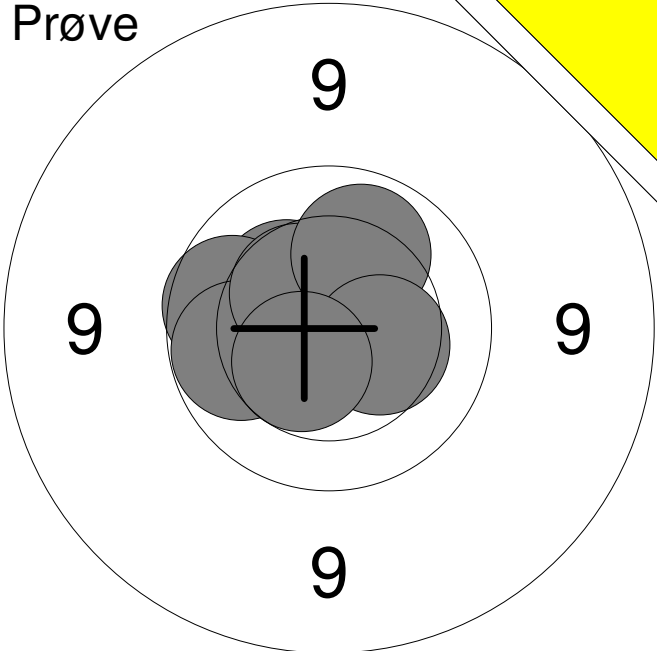
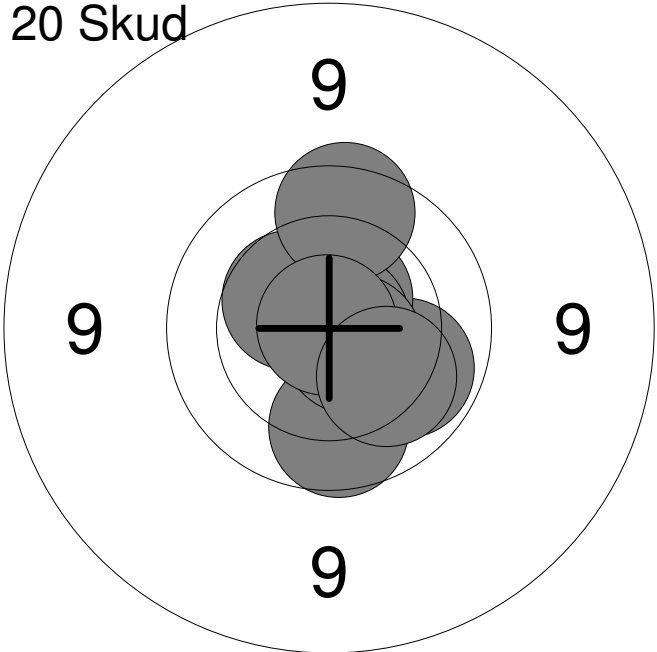
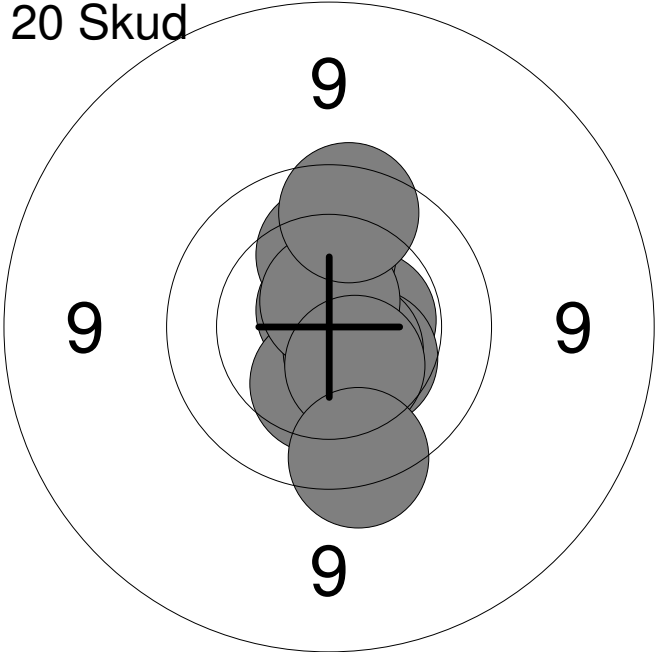
Hold	Skive	Niklas Pedersen	
22	12	Aalborg Skyttekreds	MB2
15m			
30.01.2015	Nordjysk mesterskab 2015	Aalborg Skyttekreds	
Prøve		1: 10.3 ↗	
		2: 9.9 ←	
		3: 10.0 ←	
		4: 10.5 ↗	
		5: 10.1 ↗	
		6: 10.4 →	
		7: 10.5 ↘	
		<b>Serie</b> 69.0	
		<b>Total</b> 0.0	
20 Skud		1: 9.9 ↓	
		2: 10.0 →	
		3: 10.6x ↗	
		4: 10.8x ↗	
		5: 10.8x →	
		6: 10.5 ↗	
		7: 9.8 ↑	
		8: 10.6x ↘	
		9: 10.9x ↗	
		10: 10.1 ↓	
		<b>Serie</b> 98.0	
		<b>Total</b> 98.0	
20 Skud		11: 10.8x ↑	
		12: 10.3 ↓	
		13: 10.5x →	
		14: 10.4 ↘	
		15: 10.2 ↑	
		16: 10.6x ↘	
		17: 10.7x ↑	
		18: 10.4 ↘	
		19: 9.7 ↓	
		20: 9.8 ↑	
		<b>Serie</b> 98.0	
		<b>Total</b> 196.0	